



CINOY[®]

PRODUTOS AUTOMOTIVOS



2024

CATÁLOGO

CONECTANDO
VOCÊ AO FUTURO
AUTOMOTIVO.



CINOY

QUEM SOMOS

Somos a **CINOY – Produtos Automotivos**, uma empresa importadora confiável no segmento de acessórios e peças automotivos de qualidade, com matriz em Duque de Caxias, RJ e filial em Gaspar, SC. Com uma estrada de 12 anos no mercado, nossa empresa tem o prazer de atender todo o Brasil.

Nossa linha de produtos abrange uma ampla variedade de sistemas de iluminação, palhetas, som automotivo e componentes de peças de desempenho e acessórios de estilo. Trabalhamos com os melhores fabricantes, garantindo que cada produto em nosso catálogo atenda aos mais altos padrões de qualidade e durabilidade.

Além de nossos excepcionais produtos, nos orgulhamos em oferecer um serviço de excelência aos nossos clientes. Estamos aqui para ajudar em todas as etapas do processo, desde a seleção do produto certo até o suporte pós-venda. Nosso objetivo é garantir que cada cliente tenha uma experiência positiva e satisfatória ao lidar com a CINOY.

Na CINOY, não apenas vendemos produtos automotivos – estamos comprometidos em ajudá-lo a elevar o desempenho e a estética de seu veículo. Seja você um entusiasta ou apenas um motorista casual, estamos aqui prontos para atendê-los e transformar sua visão em realidade.

ÍNDICE

ILUMINAÇÃO 08

MINI HALÓGENAS 10

LÂMPADAS LED 08

T10 CANBUS 16

LED SINCRONIZADO 17

PLACAS LED 18

LÂMPADAS LEDS 19

LED DRL 22

LEDS PARA MOTO 23

MOTO LIGHT ARROW 24

MOTO LED LIGHT 25

LEDS FLEXÍVEIS 26

AEROFÓLIO LED 27

LANTERNA LED MULTIFUNÇÕES 28

SUPER LED PLUS AMARELA 29

SUPER LED PLUS BRANCA 30

SUPER LED C6 31

POWER MAX 12V 34

POWER MAX 24V 35

LED BOOST 36

MINI PROJETOR 38

LED STAR 1:1 39

CANCELLER LED 40

FAROL DE MILHA 42

FAROL AUXILIAR 44

FAROL DE MILHA AVULSO E KIT 54

FARÓIS AVULSOS 56

FARÓIS KIT 62

PALHETAS 70

PALHETAS DIANTEIRAS ESPECÍFICAS 72

PALHETAS TRASEIRAS ESPECÍFICAS 106

PALHETAS SILICONE 148

PALHETAS TRASEIRA COM BRAÇO 168

PALHETAS DE CAMINHÃO 174

PALHETAS DE FERRO 184

PALHETAS HÍBRIDAS 206

PALHETAS DIANTEIRAS MULTI ENCAIXE 220

PALHETAS TRASEIRAS MULTI ENCAIXE 226

PALHETAS TRASEIRAS CARENADA 230

AMORTECEDORES DE PORTA-MALAS 236

CONECTORES DOS AMORTECEDORES 238

AMORTECEDORES 240

INTERRUPTORES E MOLDURAS 250

INTERRUPTORES 252

APOIO DE BRAÇO UNIVERSAL 266

ÁUDIO E VÍDEO 268

CENTRAL MULTIMÍDIA 270

RÁDIO MP5 276

RÁDIOS 290

ANTENAS 298

SEGURANÇA 300

CÂMERA DE RÉ 302

SENSORES DE RÉ 304

RETROVISORES ELETRÔNICOS 305

ESPELHOS RETROVISORES 306

RETROVISOR 2X1 BABY 307

CUSTOM & REPARO 308

CABO CHUPETA 310

TAMPA DE BICO/CAPA PARAFUSO/COMPRESSOR 311

PONTEIRA DE ESCAPAMENTO 312

PEDALEIRAS 313

TAPETES/CAPAS DE VOLANTE 314

MINI VENTILADORES 315

ACENDEDOR DE CIGARRO 315

FITAS ISOLANTES 315

CHAVES DE RODA 316

MACACOS HIDRÁULICOS 318

TRAVAS 319

PEÇAS 320

BUZINAS 322

BOMBAS DE COMBUSTÍVEL 324

BOMBAS DE MOTO 325

BOMBAS DE GASOLINA/ÁGUA 326

CARCAÇAS 327

MOTOR/TERMINAL/RELÊ 329

MOTOR TRAVA/MÁQUINA 330

CEBOLÃO 331



ILUMINAÇÃO

LUMINAÇÃO

1 POLO
AMARELO

12V / 5 W
✓✓
YN-12/0067
2000/CX



1 POLO
AMARELO

12V / 4 W
✓✓
YN-12/0069
3000/CX



1 POLO
AMARELO

21V / 5 W
✓✓
YN-12/1034
1000/CX



1 POLO
AMBAR

21V / 5 W
✓✓
YN-12/1056AM
1000/CX



H7TP
AMARELO

24V / 70 W
✓✓
YN-24/H7TP
500/CX



H1T
AMARELO

12V / 55 W
✓✓
YN-12/H1T
600/CX



H3T
AMARELO

12V / 55 W
✓✓
YN-12/H3T
600/CX



H4T
AMARELO

12V / 55 W
✓✓
YN-12/H4T
200/CX



1 POLO
AMARELO

21V / 5 W
✓✓
YN-12/1056BR
1000/CX



1 POLO
AMARELO

12V / 21 W
✓✓
YN-12/1141
1000/CX



1 POLO
AMBAR

12V / 21 W
✓✓
YN-12/1141AM
1000/CX



1 POLO
AMARELO

12V / 16 W
✓✓
YN-12/T15
1000/CX



H7T
AMARELO

12V / 55 W
✓✓
YN-12/H7T
500/CX



H8T
AMARELO

12V / 35 W
✓✓
YN-12/H8T
250/CX



H11T
AMARELO

12V / 55 W
✓✓
YN-12/H11T
250/CX



H15T
AMARELO

55V / 15 W
✓✓
YN-12/H15T
200/CX



1 POLO
AMARELO

12V / 1,2 W
✓✓
YN-12/2721
3000/CX



1 POLO
AMARELO

12V / 5 W
✓✓
YN-12/2825
3000/CX



1 POLO
AMARELO

12V / 5 W
✓✓
YN-12/2825A
1000/CX



1 POLO
AMARELO

12V / 21 W
✓✓
YN-12/6941
1000/CX



H16T
AMARELO

12V / 24 W
✓✓
YN-12/H16
500/CX



H16T-L
AMARELO

12V / 24 W
✓✓
YN-12/H16T-L
500/CX



9005T
AMARELO

12V / 60 W
✓✓
YN-12/9005T
250/CX



9006T
AMARELO

12V / 51 W
✓✓
YN-12/9006T
250/CX



1 POLO
AMARELO

21V / 5 W
✓✓
YN-12/6942
1000/CX



1 POLO
AMARELO
44MM

12V / 10 W
✓✓
YN-12/6411
5000/CX



1 POLO
AMARELO
35MM

12V / 5 W
✓✓
YN-12/6418
5000/CX



1 POLO
AMARELO
39MM

12V / 5 W
✓✓
YN-L1346
5000/CX



9012T
AMARELO

12V / 55 W
✓✓
YN-12/9012T
200/CX



H21T
AMARELO

12V / 21 W
✓✓
YN-12/H21T
250/CX



H27T
AMARELO

12V / 27 W
✓✓
YN-12/H27T
500/CX



H1AP
SUPER BRANCA

12V / 55 W
✓✓
YN-12/H1AP
600/CX



1 POLO
AMARELO
41MM

12V / 5 W
✓✓
YN-L1347
5000/CX



1 POLO
AMARELO
31MM

12V / 5 W
✓✓
YN-L1348
5000/CX



1 POLO
AMARELO

21V / 4 W
✓✓
YN-12/7225
1000/CX



1 POLO
AMARELO

24V / 21 W
✓✓
YN-24/1141TP
1000/CX



H3AP
SUPER BRANCA

12V / 55 W
✓✓
YN-12/H3AP
600/CX



H4AP
SUPER BRANCA

12V / 55 W
✓✓
YN-12/H4AP
200/CX



H7AP
SUPER BRANCA

12V / 55 W
✓✓
YN-12/H7AP
500/CX



H11AP
SUPER BRANCA

12V / 55 W
✓✓
YN-12/H11AP
250/CX



2 POLOS
AMARELO

21V / 5 W
✓✓
YN-24/1034TP
1000/CX



H1TP
AMARELO

24V / 70 W
✓✓
YN-24/H1TP
1000/CX



H3TP
AMARELO

24V / 70 W
✓✓
YN-24/H3TP
1000/CX



H4TP
AMARELO

75V / 70 W
✓✓
YN-24/H4TP
200/CX



H16AP
SUPER BRANCA

12V / 24 W
✓✓
YN-12/H16AP
500/CX



H16AP-L
SUPER BRANCA

12V / 55 W
✓✓
YN-12/H16AP-L
200/CX



9005AP
SUPER BRANCA

12V / 60 W
✓✓
YN-12/9005AP
250/CX



9006AP
SUPER BRANCA

12V / 51 W
✓✓
YN-12/9006AP
250/CX



H27AP

SUPER BRANCA

12V / 27 W



YN-12/H27AP
50/CX



H1A

AMARELO

12V / 55 W



YN-12/H1A
50/CX



H3A

SUPER BRANCA

12V / 55 W



YN-12/H3A
50/CX



H4A

SUPER BRANCA

12V / 55 W



YN-12/H4A
50/CX



H7A

SUPER BRANCA

12V / 55 W



YN-12/H7A
50/CX



H8A

SUPER BRANCA

12V / 35 W



YN-12/H8A
50/CX



H11A

SUPER BRANCA

12V / 55 W



YN-12/H11A
50/CX



9005A

SUPER BRANCA

12V / 60 W



YN-12/9005A
50/CX



9006A

SUPER BRANCA

12V / 51 W



YN-12/9006A
50/CX



H16A

SUPER BRANCA

12V / 24 W



YN-12/H16A
50/CX



H16A-L

SUPER BRANCA

12V / 24 W



YN-12/H16A-L
50/CX



H27A

SUPER BRANCA

12V / 27 W



YN-12/H27A
50/CX



A grande vantagem das lâmpadas halógenas é a facilidade com que podem ser substituídas. Em caso de falha da lâmpada, o proprietário do veículo pode adquirir uma nova lâmpada e trocá-la facilmente, sem a necessidade de ferramentas especializadas ou conhecimento técnico avançado. Isso significa que os motoristas podem manter suas luzes em pleno funcionamento com um mínimo de esforço e tempo perdido.



AS HALÓGENAS

As lâmpadas halógenas têm sido uma escolha popular há décadas, fornecendo iluminação confiável para veículos em todo o mundo. Essas lâmpadas são uma forma de tecnologia de iluminação incandescente que utiliza um filamento de tungstênio dentro de uma cápsula de quartzo cheia de gás halógeno. Esse design permite uma boa eficiência e uma boa vida útil, tornando-as uma opção atraente.

Desempenho e Visibilidade

Como principal característica temos seu desempenho em termos de visibilidade. Elas produzem uma luz branca e brilhante que é essencial para uma condução segura, especialmente em condições de pouca luz ou em ambientes adversos, como chuva e nevoeiro. A luz emitida pelas lâmpadas halógenas tem uma boa capacidade de penetrar na escuridão, proporcionando ao motorista uma visão clara da estrada à frente e dos arredores.

LANÇAMENTO



LÂMPADAS T20

Aplicação:

- Luz de ré
- Luz de freio
- Piscas dianteiros
- Luz do travão traseiro

NADA DE TINTA!

LÂMPADA DE VIDRO COLORIDO





LAMPADAS LED

LAMPADAS
LED

CINDOY

T10 CANBUS 12V

YN-L0637



- **CONTROLE REMOTO**
- **16 CORES**
- **12V/21W**
- ALTO BRILHO
- ALTA QUALIDADE
- FÁCIL INSTALAÇÃO

TENHA UM VISUAL MAIS ESPORTIVO NO SEU CARRO!



MAIOR INTENSIDADE NA ILUMINAÇÃO



16 CORES PARA O INTERIOR DO CARRO



ILUMINAÇÃO PARA A SUA PLACA

LED SINCRONIZADO

YN-L0638



- **8 CORES**
- **À SUA ESCOLHA POR CONTROLE REMOTO**
- LUZES SINCRONIZADAS COM O RITMO DA MÚSICA
- 4 FUNÇÕES DE SINCRONIA

É UM SHOW!!! DANÇA CONFORME A MÚSICA!



PLACAS LED AUTOMOTIVO



YN-LH1847

24 LEDS

12V / 5W



PLACA LED (AXL): 2,6 X 4,6 CM

CONTEÚDO:
01 PLACA DE 24 LEDS / ENCAIXE
PINGO T10 - ENCAIXE TORPEDO



YN-LH1848

12 LEDS

12V / 2,5W



PLACA LED (AXL): 2,3 X 3 CM

CONTEÚDO:
01 PLACA DE 12 LEDS / ENCAIXE
PINGO T10 - ENCAIXE TORPEDO



Aplicação interna como luz
de teto ou porta-malas.



YN-LH1849

2 POLOS

12V / 7W



LUZ BRANCA - 18 LEDS
185L - BASE BAY 15D



YN-LH1850

1 POLO

12V / 7W



LUZ BRANCA - 18 LEDS
185L - BASE BAY 15D



LÂMPADAS
COMUNS

LÂMPADAS
LEDS



**LED T5 (2721) B8.5
PARA PAINEL**

SUORTE MOSQUITO

12V / 60W



YN-LH001
200 PARES/CX



**LED T5 WG 1SMD
5050 BRANCO**

12V / 60W



YN-LH002
200 PARES/CX



**LED T10 WG 15SMD
3528 BRANCO**

12V / 60W



YN-LH003
200 PARES/CX



**LED T10 WG 28SMD
3528 BRANCO**

12V / 60W



YN-LH004
200 PARES/CX



**LED T10 4
LED SMD E 1 LED 5W**

12V / 60W



YN-LH006
200 PARES/CX



**LED T10 7 LED 6000K
EFEILAMP. LED TO
XENON BRANCO 5W**

12V / 60W



YN-LH007
200 PARES/CX



**LED T10-9SMD
5050 BRANCA**

12V / 60W



YN-LH020
200 PARES/CX



**LED 22SMD BRANCA
2 POLOS CABEÇA
CORTADA**

12V / 60W



YN-LH023
200 PARES/CX



**LED 2 POLO
1157 BRANCA**

12V / 60W



YN-LH023CO
200 PARES/CX



**LED 22SMD BRANCA
1 POLO CABEÇA
CORTADA**

12V / 60W



YN-LH024
200 PARES/CX



**LED 1 POLO
1156 BRANCA**

12V / 60W



YN-LH024CO
200 PARES/CX



**LED T10-4SMD
3528 BRANCA**

12V / 60W



YN-LH025
200 PARES/CX



**LED T10-4SMD
3528 AZUL**

12V / 60W
✓ ✓
YN-LH026
200 PARES/CX



**LED T10-5SMD
5050 BRANCA**

12V / 60W
✓ ✓
YN-LH027
200 PARES/CX



**LED T10-5SMD
5050 AZUL**

12V / 60W
✓ ✓
YN-LH027AZ
200 PARES/CX



**LED T10
5050 BRANCA
TROBO**

12V / 60W
✓ ✓
YN-LH027E
200 PARES/CX



**LED TORPEDO
39MM 4SMD
5050 BRANCO**

12V / 60W
✓ ✓
YN-LH034-39CO
200 PARES/CX



**LED TORPEDO
41MM 4SMD
5050 BRANCO**

12V / 60W
✓ ✓
YN-LH034-41CO
200 PARES/CX



**LED TORPEDO
44MM 4SMD
5050 BRANCO**

12V / 60W
✓ ✓
YN-LH034-44CO
200 PARES/CX



**LED BASE 69 5 LEDS
5050 BRANCA**

12V / 60W
✓ ✓
YN-LH069
200 PARES/CX



**LED T10-8SMD
2835 BRANCA**

12V / 60W
✓ ✓
YN-LH030
200 PARES/CX



**LED TORPEDO
31MM 6 LEDS
BRANCO**

12V / 60W
✓ ✓
YN-LH034-31SUP
200 PARES/CX



**LED TORPEDO
36MM 6 LEDS
BRANCO**

12V / 60W
✓ ✓
YN-LH034-36SUP
200 PARES/CX



**LED TORPEDO
39MM 6 LEDS
BRANCO**

12V / 60W
✓ ✓
YN-LH034-39SUP
200 PARES/CX



**LED T10 6 LEDS
SILICONE CANCELLER**

12V / 60W
✓ ✓
YN-LH1578
200 PARES/CX



**LED TORPEDO
41MM 6 LEDS
BRANCO**

12V / 60W
✓ ✓
YN-LH034-41SUP
200 PARES/CX



**LED TORPEDO
44MM 6 LEDS
BRANCO**

12V / 60W
✓ ✓
YN-LH034-44SUP
200 PARES/CX



**LED TORPEDO
31MM 4SMD
5050 BRANCO**

12V / 60W
✓ ✓
YN-LH034-31CO
200 PARES/CX



**LED TORPEDO
36MM 4SMD
5050 BRANCO**

12V / 60W
✓ ✓
YN-LH034-36CO
200 PARES/CX



LED AUTOMOTIVO 2 POLOS · 45 LEDs SMD BRANCO

LANÇAMENTO

CÓDIGO
YN-LL2166

ALTA QUALIDADE

DURA25^x
MAIS
que as lâmpadas comuns

- ▶ Com 45 x 4014 diodos SMD que se encaixam na BASE BA15d.
- ▶ Base: BA15d · P21W · 1157
Voltagem: 12V
- ▶ Comprimento: 50mm
Diâmetro: 15mm



✓ EXPECTATIVA VIDA ÚTIL
30.000 HORAS



Embalagem:
2 unidades



LED AUTOMOTIVO 1 POLO · 45 LEDs SMD BRANCO

LANÇAMENTO

CÓDIGO
YN-LL2166

ALTA QUALIDADE

DURA25^x
MAIS
que as lâmpadas comuns

- ▶ Com 45 x 4014 diodos SMD que se encaixam na BASE BA15d.
- ▶ Base: BA15d · P21W · 1157
Voltagem: 12V
- ▶ Comprimento: 50mm
Diâmetro: 15mm



✓ EXPECTATIVA VIDA ÚTIL
30.000 HORAS



Embalagem:
2 unidades



LED AUTOMOTIVO · T15 · 45 LEDs SMD BRANCO

LANÇAMENTO

CÓDIGO
YN-LL2168

ALTA QUALIDADE

DURA25^x
MAIS
que as lâmpadas comuns

- ▶ Com 45 x 4014 diodos SMD que se encaixam na BASE T15.
- ▶ Base: T15 · P6W · 4014
Voltagem: 12V
- ▶ Comprimento: 40mm
Largura: 9mm



✓ EXPECTATIVA VIDA ÚTIL
30.000 HORAS



Embalagem:
2 unidades

MINI LED AUTOMOTIVO · T10 · 26 LEDs SMD BRANCO

LANÇAMENTO

CÓDIGO
YN-LL2169

ALTA QUALIDADE

DURA25^x
MAIS
que as lâmpadas comuns

- ▶ Com 26 x 4014 diodos SMD que se encaixam na BASE T10.
- ▶ Base: T10 · P5W · 4014
Voltagem: 12V
- ▶ Comprimento: 32mm
Largura: 5mm



✓ EXPECTATIVA VIDA ÚTIL
30.000 HORAS



Embalagem:
2 unidades

MINI LED AUTOMOTIVO · T5 · 3 LEDs SMD BRANCO

LANÇAMENTO

CÓDIGO
YN-LL2170

ALTA QUALIDADE

DURA25^x
MAIS
que as lâmpadas comuns

- ▶ Com 3 x 3030 diodos SMD que se encaixam na BASE T5.
- ▶ Base: T5 · P3W · 3030
Voltagem: 12V
- ▶ Comprimento: 17vmm
Largura: 5mm



✓ EXPECTATIVA VIDA ÚTIL
30.000 HORAS



Embalagem:
2 unidades

KIT CONVERSÃO LED DRL DUAL COLOR



42
LEDS

950
LÚMENS
>>PAR

À PROVA D'ÁGUA
PROTEÇÃO
IP67

Função DRL
e Seta

Potência
50W

Voltagem
12V

Temperatura
de operação
-10° a +60°



96
LEDS

950
LÚMENS
>>PAR

À PROVA D'ÁGUA
PROTEÇÃO
IP67

Função DRL
e Seta

Potência
50W

Voltagem
12V

Temperatura
de operação
-10° a +60°



LEDS PARA MOTO



**LED PARA
MOTO M5
BRANCA - FAROL**

12V / 6W



YN-ML01

200 PARES/CX



**LED PARA
MOTO H4
BRANCA - FAROL**

12V / 6W



YN-ML02

200 PARES/CX



**SUPER LED PARA
MOTO H4
BRANCA - FAROL
1.500 LÚMENS**

12V / 5W



YN-ML1483

50/CX



**LED PARA MOTO
BRANCA
4.400 LÚMENS**

12V / 40W



YN-ML1484

50/CX



H4MT
AMARELO

35V / 35 W



YN-12/H4MT

200/CX



H4MA
SUPER BRANCA

35V / 35 W



YN-12/MA

200/CX

YN-ML2062

ENCAIXE UNIVERSAL

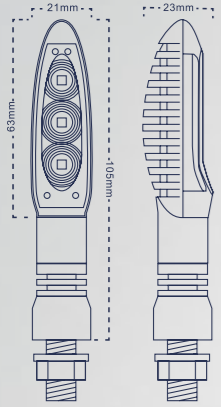

ACESO E SETA AMARELA

YN-ML2063

ENCAIXE UNIVERSAL
PISCA SEQUENCIAL

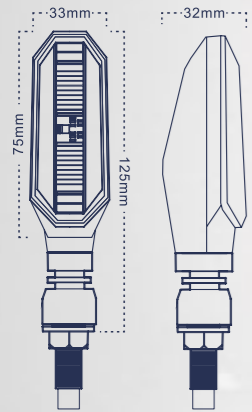

ACESO E SETA AMARELA

YN-ML2064

ENCAIXE UNIVERSAL
PISCA SEQUENCIAL

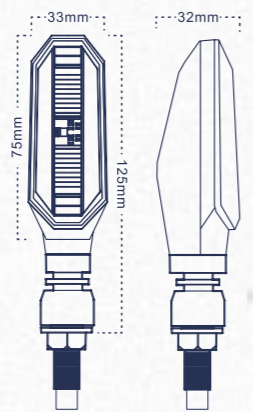

ACESO E SETA AMARELA

YN-ML2065

MELHOR GUSTO-BENEFÍCIO

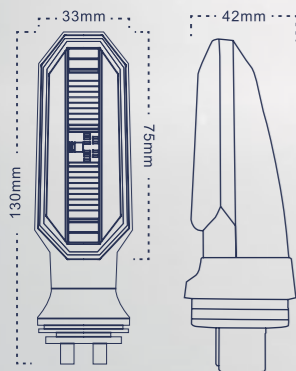

ACESO E SETA AMARELA

YN-ML2066

ENCAIXE UNIVERSAL

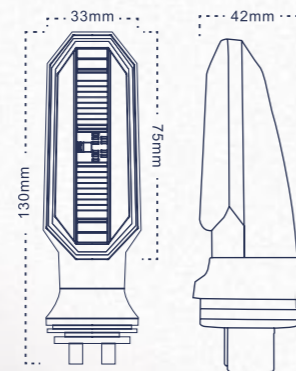

ACESO E SETA AMARELA

MOTO LIGHT
ARROW

MOTO
led light

MOTO
led light

YN-ML2058

FAROL 10W
ALTO E BAIXO

450 LM
MUITO MAIS BRILHO

6.500 °K
LUZ BRANCA

SUPORTA TREPIDAÇÕES

EFICIÊNCIA DE ENERGIA



10uni./cx.

YN-ML2060

FAROL 10W
ALTO E BAIXO

450 LM
MUITO MAIS BRILHO

6.500 °K
LUZ BRANCA

SUPORTA TREPIDAÇÕES

EFICIÊNCIA DE ENERGIA



10uni./cx.

YN-ML2067

FAROL 10W
ALTO E BAIXO

3.200 LM
MUITO MAIS BRILHO

6.500 °K
LUZ BRANCA

SUPORTA TREPIDAÇÕES

EFICIÊNCIA DE ENERGIA



10uni./cx.

YN-ML2057

FAROL 10W
ALTO E BAIXO

1.000 LM
MUITO MAIS BRILHO

6.500 °K
LUZ BRANCA

SUPORTA TREPIDAÇÕES

EFICIÊNCIA DE ENERGIA



10uni./cx.

YN-ML2059

FAROL 10W
ALTO E BAIXO

1.000 LM
MUITO MAIS BRILHO

6.500 °K
LUZ BRANCA

SUPORTA TREPIDAÇÕES

EFICIÊNCIA DE ENERGIA



10uni./cx.



**BARRA LED FLEXÍVEL
USO INTERNO 12V**

- 30cm YN-LF30D1834
- 45cm YN-LF45D1835
- 60cm YN-LF60D1836

- Alta flexibilidade e adaptabilidade
- Impermeável Proteção LP67
- Corte permitido entre 2,5 x 2,5cm
- Instalação feita na parte interna do farol





**BARRA LED FLEXÍVEL
USO EXTERNO 12V**

- 30cm YN-LF30E1837
- 45cm YN-LF45E1838
- 60cm YN-LF60E1839

- Estilo Angel Eye Farol DRL
- Impermeável Proteção LP67
- Fácil Instalação
- Funções: Setá - Luz Amarela Farol - Luz Branca



POSSUI FITA DUPLA-FACE



**FITA LED INTERNA 12V
ESTILO NEON**

- BRANCA YN-LFBR1842
- AZUL YN-LFAZ1843
- TURQUESA YN-LFAF1844

- 5 metros
- Visual Esportivo
- Embalagem: 1 unid.
- Fácil Instalação: Via Acendedor



**FITA LED AUTOMOTIVA 12V
PARA PORTA-MALAS
YN-LF1851**

- 1,2 metros com 60 LEDs
- Potência 10W
- Fácil Instalação

+ Segurança e Estilo ao andar e ao frear!

- FIO PRETO CONECTA-SE AO NEGATIVO
- FIO VERMELHO CONECTA-SE AO POSITIVO



AZUL FRIO AO DIRIGIR OU COLORIDO (OPCIONAL) Quando o fio verde estiver conectado ao positivo, ele acenderá com luz azul frio.	SETAS ESQUERDA E DIREITA Os fios amarelos conectam as setas direita e esquerda.	PISCA ALERTA E LUZ DE FREIO VERMELHO O fio branco deve se conectar ao fio de freio para ser acionado simultaneamente.	O fio azul aciona a ré
---	---	---	-------------------------------

AEROFÓLIO LED



CINOY PRODUTOS AUTOMOTIVOS YN-AL001

AEROFÓLIO LED

YN-AL001P

YN-AL001G

YN-AL001B

Deixa o visual mais atraente e esportivo!

- Funciona em conjunto com a luz de freio
- Pode ser adaptado para carros menores
- Disponível em 3 cores: Branco, Grafite e Preto

120x3,5cm (CxL)

FÁCIL INSTALAÇÃO

0% DANIFICAÇÃO

POSSUI FITA DUPLA-FACE

POSSÍVEIS APLICAÇÕES



YN-BL1386



Aplicável em Motos, Carros e outros.
Funções: Meia Luz e Luz de Freio

ENCAIXE UNIVERSAL

12LEDS • 12V

YN-BLC3089



- Aplicação em: Carreta, Reboque, Trator e outros.
- Função de luz delimitadora de distância.

12LEDS • 12V/24V

YN-BLC3090



- Aplicação em: Carreta, Reboque, Trator e outros.
- Função de luz delimitadora de distância.

12LEDS • 12V/24V

YN-BLC1388 (LADO ESQUERDO)

YN-BLC1389 (LADO DIREITO)

5 FUNÇÕES

- Luz de Cidade
- Luz de Placa
- Luz de Seta
- Luz de Pisca Alerta
- Luz de Freio (mais forte ao frear)



Resistente à água, poeira, lama e ferrugem interna.

APLICAÇÃO: caminhão, carreta, caçamba, baú, ônibus, trator, esteira, jipe e outros.

LANTERNA BIVOLT
12V/24V



SUPERLED PLUS AMARELA



EFICIÊNCIA DE ENERGIA



MUITO MAIS BRILHO



6500°K

LUZ AMARELA



FOCO PERFEITO



FÁCIL INSTALAÇÃO

0% DANIFICAÇÃO



À PROVA D'ÁGUA • RESISTE À POEIRA **IP65**

ILUMINAÇÃO COM FOCO ATÉ **150M**

SUPERLED PLUS BRANCA



EFICIÊNCIA DE ENERGIA



MUITO MAIS BRILHO



6500 °K

LUZ BRANCA



FOCO PERFEITO



YN-LSL9006P

7,5cm



YN-LSLH1P

6,5cm



YN-LSLH3P

5,7cm



YN-LSLH4P

8cm



YN-LSLH7P

7cm



YN-LSLH11P

7,5cm



YN-L13P0697

8cm



YN-LSLH15P

8cm



YN-LSLH16P

6,5cm



YN-LSLH27P

7,2cm



VCLEAR
BY CINOY

SUPERLED C6 6000K



VL-L9005-1337

8cm



VL-LH1-1338

8,5cm



VL-LH3-1339

7,5cm



VL-LH4-1334

8,5cm



VL-LH7-1336

8cm



VL-LH11-1335

8cm



VL-LH16-1340

7,5cm



VL-LH27-1341

8cm





ULTRA LED POWER MAX

LANÇAMENTO

10.000 LÚMENS >>PAR

- ▶ EFICIÊNCIA ENERGÉTICA
- ▶ MÁXIMA LUMINOSIDADE
- ▶ MELHOR PERFORMANCE
- ▶ TECNOLOGIA E INOVAÇÃO

FÁCIL INSTALAÇÃO
0%
DANIFICAÇÃO

MUITO MAIS BRILHO

FOCO PERFEITO

EFICIÊNCIA DE ENERGIA

10.000 LM
MAIS LUMINOSIDADE

6.000 °K
LUZ BRANCA

30 W
POTÊNCIA

MUITO MAIS BRILHO

6.000 °K
LUZ BRANCA

FOCO PERFEITO

EFICIÊNCIA DE ENERGIA

Dissipador de calor
Ventoinha 2cm

Reator vermelho emborrachado



EFICIÊNCIA ENERGÉTICA

TECNOLOGIA E INOVAÇÃO

MÁXIMA LUMINOSIDADE

MELHOR PERFORMANCE

À PROVA D'ÁGUA
RESISTE À POEIRA
IP65

ILUMINAÇÃO COM FOCO ATÉ **150M**



ULTRA LED POWER MAX 24V

LANÇAMENTO

LED BOOST

Silencioso

Chip 3570

Forte

Estável

LED BOOST

CINOY
PRODUTOS AUTOMOTIVOS

FÁCIL
INSTALAÇÃO

0%
DANIFICAÇÃO

Eficiente

YN-BSH4



MUITO MAIS
BRILHO



MAIS
LUMINOSIDADE



LUZ
BRANCA



FOCO
PERFEITO



EFICIÊNCIA DE
ENERGIA



MINIPROJETOR



YN-PRMH4



YN-PRMH7



YN-PRMH11



YN-PRM9005/6/12



5.700 °K
LUZ BRANCA

2500 LX
FAROL BAIXO

3.800 LX
FAROL ALTO

MUITO MAIS BRILHO

EFICIÊNCIA DE ENERGIA

Dissipador de Calor

Ventoinha 2,5cm



LED STAR 101



MUITO MAIS BRILHO



FOCO PERFEITO



EFICIÊNCIA DE ENERGIA

6.500 LM

MAIS LUMINOSIDADE

6000 °K

LUZ BRANCA

30 W

POTÊNCIA



YN-FL9005-9006

7 CM



YN-FL9012

7 CM



YN-FLH1

6 CM



YN-FLH3

5 CM



YN-FLH4

7,8 CM



YN-FLH7

6 CM



YN-FLH8

6 CM



YN-FLH27

7,5 CM



EFICIÊNCIA ENERGÉTICA



MÁXIMA LUMINOSIDADE



MELHOR PERFORMANCE



TENCOLOGIA E INOVAÇÃO



À PROVA D'ÁGUA
RESISTE À POEIRA

IP65



ILUMINAÇÃO COM FOCO ATÉ **150M**



YN-CH1-1566
YN-CH3-1571
12V PAR



YN-CH7-1568
12V PAR



YN-CH13-1571
12V PAR



YN-CH13-1571
12V PAR



YN-CH16-1572
12V PAR



YN-CH11-1569
YN-CH880-1573
YN-CHB-1570
12V PAR

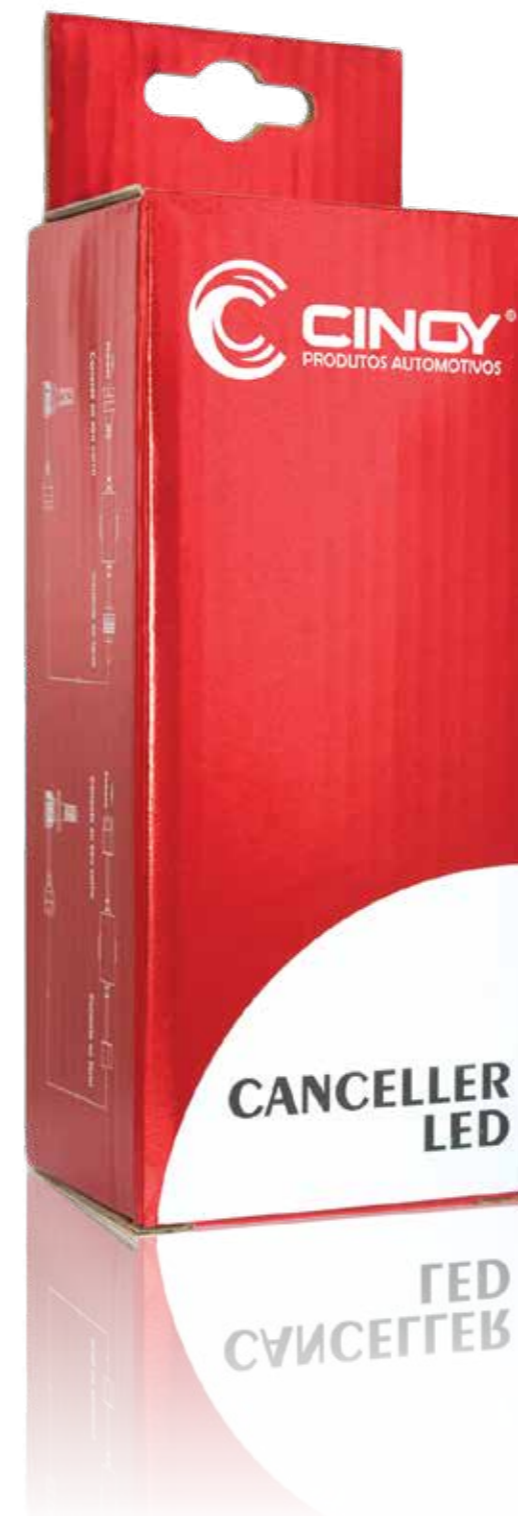

CANCELLER PARA LED

Warning Cancellor Universal ou simplesmente **Cancellor Led**, são exclusivos adaptadores **CINQY CANBUS** para lâmpadas leds e/ou xenon, consiste em um equipamento que funciona como um capacitor, para resolver possíveis problemas relacionados aos avisos de erro no painel e acabar com a oscilação da lâmpada. Por ser um produto importado, de alta qualidade, você instala um em cada lâmpada e esquece, considerando seu grande desempenho.

Instalação Fácil

Com um design avançado, o adaptador **CANBUS** pode ser instalado com facilidade para oferecer bom desempenho desde o primeiro dia. Desempenho ideal em todas as condições mais exigentes, em uso diário no compartimento do motor.

- ESPECIFICAÇÕES TÉCNICAS:
- FUNÇÃO PROGRESSIVA
- EVITA SINAIS DE ERRO NO PAINEL
- DESEMPENHO ELÉTRICO PERFEITO
- SISTEMA ELETRÔNICO SEM EMISSÃO DE CALOR
- CONTEÚDO:
- 1 PAR CANCELLER LED

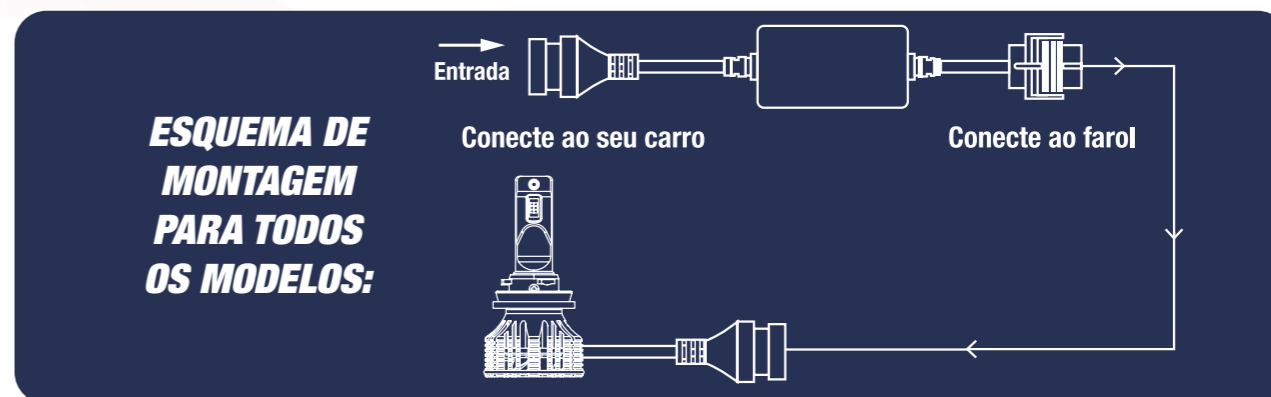



FAROL DE MILHA

FAROL DE MILHA

YN-FA001



1.800 LM
MAIS LUMINOSIDADE

7.000 °K
LUZ BRANCA

27W
LUZ BRANCA

FICHA TÉCNICA:

9 LEDs
DESC: FAROL AUXILIAR
TENSÃO OPERACIONAL: 10-80V DC
MODULO LED: 3W I PCS CREE LEDS
MATERIAL DA LENTE: PC
FEIXE: SPOT, FLOOD, COMBO
RESISTÊNCIA À ÁGUA: IP65 (Submersível)
MATERIAL DA CAIXA: LATÃO
TEMPO DE VIDA: 20.000 HORAS
LINHA LEVE E PESADA

FICHA TÉCNICA:

9 LEDs
DESC: FAROL AUXILIAR
TENSÃO OPERACIONAL: 10-80V DC
MODULO LED: 3W I PCS CREE LEDS
MATERIAL DA LENTE: PC
FEIXE: SPOT, FLOOD, COMBO
RESISTÊNCIA À ÁGUA: IP65 (Submersível)
MATERIAL DA CAIXA: LATÃO
TEMPO DE VIDA: 30.000 HORAS
LINHA LEVE E PESADA

1.800 LM
MAIS LUMINOSIDADE

7.000 °K
LUZ BRANCA

27W
LUZ BRANCA

YN-FA009



YN-FA002



3.840 LM
MAIS LUMINOSIDADE

7.000 °K
LUZ BRANCA

48W
LUZ BRANCA

FICHA TÉCNICA:

16 LEDs
DESC: FAROL AUXILIAR
TENSÃO OPERACIONAL: 10-80V DC
MODULO LED: 3W I PCS CREE LEDS
MATERIAL DA LENTE: PC
FEIXE: SPOT, FLOOD, COMBO
RESISTÊNCIA À ÁGUA: IP65 (Submersível)
MATERIAL DA CAIXA: LATÃO
TEMPO DE VIDA: 50.000 HORAS
LINHA LEVE E PESADA

FICHA TÉCNICA:

14 LEDs
DESC: FAROL AUXILIAR
TENSÃO OPERACIONAL: 10-30V DC
MODULO LED: 3W I PCS CREE LEDS
MATERIAL DA LENTE: PC
FEIXE: SPOT, FLOOD, COMBO
RESISTÊNCIA À ÁGUA: IP65 (Submersível)
MATERIAL DA CAIXA: LATÃO
TEMPO DE VIDA: 30.000 HORAS
LINHA LEVE E PESADA

4.200 LM
MAIS LUMINOSIDADE

7.000 °K
LUZ BRANCA

42W
LUZ BRANCA

YN-FA0596



YN-FA006

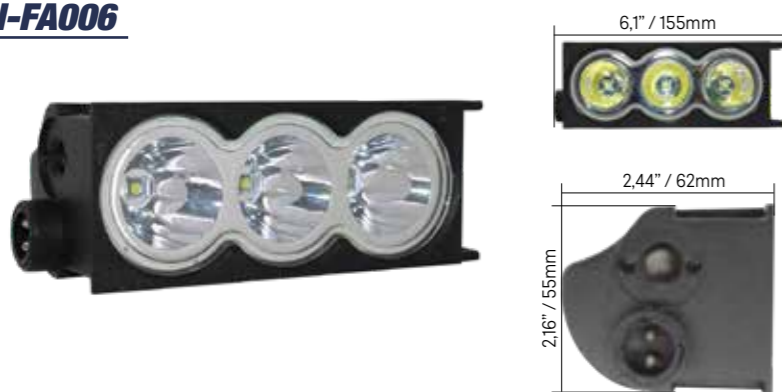

2.160 LM
MAIS LUMINOSIDADE

7.000 °K
LUZ BRANCA

27W
LUZ BRANCA

FICHA TÉCNICA:

9 LEDs
DESC: FAROL AUXILIAR
TENSÃO OPERACIONAL: 10-80V DC
MODULO LED: 3W I PCS CREE LEDS
MATERIAL DA LENTE: PC
FEIXE: SPOT, FLOOD, COMBO
RESISTÊNCIA À ÁGUA: IP65 (Submersível)
MATERIAL DA CAIXA: LATÃO
TEMPO DE VIDA: 20.000 HORAS
LINHA LEVE E PESADA

FICHA TÉCNICA:

4 LEDs
DESC: FAROL AUXILIAR
TENSÃO OPERACIONAL: 10-30V DC
MODULO LED: 3W I PCS CREE LEDS
MATERIAL DA LENTE: PC
FEIXE: SPOT, FLOOD, COMBO
RESISTÊNCIA À ÁGUA: IP65 (Submersível)
MATERIAL DA CAIXA: LATÃO
TEMPO DE VIDA: 30.000 HORAS
LINHA LEVE E PESADA

960 LM
MAIS LUMINOSIDADE

7.000 °K
LUZ BRANCA

12W
LUZ BRANCA

YN-FA0597

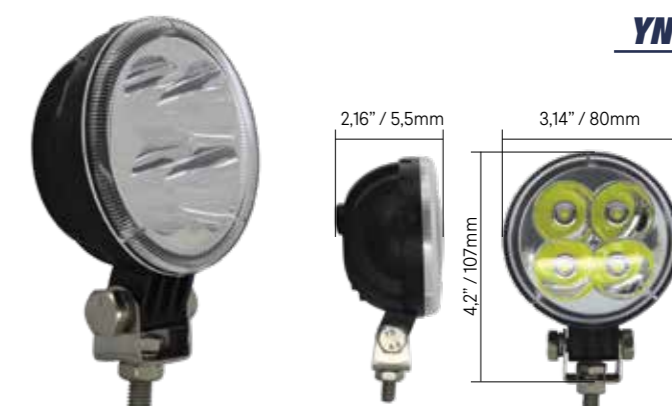

YN-FA008



2.160 LM
MAIS LUMINOSIDADE

7.000 °K
LUZ BRANCA

27W
LUZ BRANCA

FICHA TÉCNICA:

9 LEDs
DESC: FAROL AUXILIAR
TENSÃO OPERACIONAL: 10-80V DC
MODULO LED: 3W I PCS CREE LEDS
MATERIAL DA LENTE: PC
FEIXE: SPOT, FLOOD, COMBO
RESISTÊNCIA À ÁGUA: IP65 (Submersível)
MATERIAL DA CAIXA: LATÃO
TEMPO DE VIDA: 20.000 HORAS
LINHA LEVE E PESADA

FICHA TÉCNICA:

8 LEDs
DESC: FAROL AUXILIAR AZUL
TENSÃO OPERACIONAL: 10-30V DC
MODULO LED: 3W I PCS CREE LEDS
MATERIAL DA LENTE: PC
FEIXE: SPOT, FLOOD, COMBO
RESISTÊNCIA À ÁGUA: IP65 (Submersível)
MATERIAL DA CAIXA: LATÃO
TEMPO DE VIDA: 50.000 HORAS
LINHA LEVE E PESADA

1.960 LM
MAIS LUMINOSIDADE

7.000 °K
LUZ BRANCA

24W
LUZ BRANCA

YN-FA0598

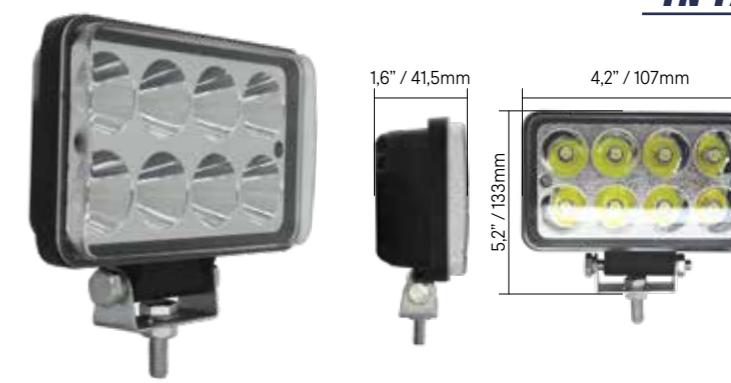

YN-FA0600



3.600 LM
MAIS LUMINOSIDADE

7.000 °K
LUZ BRANCA

45W
LUZ BRANCA

FICHA TÉCNICA:

15 LEDs
DESC: FAROL AUXILIAR
TENSÃO OPERACIONAL: 10-30V DC
MODULO LED: 3W I PCS CREE LEDS
MATERIAL DA LENTE: PC
FEIXE: SPOT. FLOOD, COMBO
RESISTÊNCIA À ÁGUA: IP67 (Submersível)
MATERIAL DA CAIXA: LATÃO
TEMPO DE VIDA: 30.000 HORAS
LINHA LEVE E PESADA

FICHA TÉCNICA:

9 LEDs
DESC: FAROL AUXILIAR AZUL
TENSÃO OPERACIONAL: 12-24V DC
MODULO LED: 3W I PCS CREE LEDS
MATERIAL DA LENTE: PC
FEIXE: SPOT. FLOOD, COMBO
RESISTÊNCIA À ÁGUA: IP67 (Submersível)
MATERIAL DA CAIXA: LATÃO
TEMPO DE VIDA: 50.000 HORAS
LINHA LEVE E PESADA

550 LM
MAIS LUMINOSIDADE

7.500 °K
LUZ BRANCA

27W
LUZ AZUL

YN-FA1506

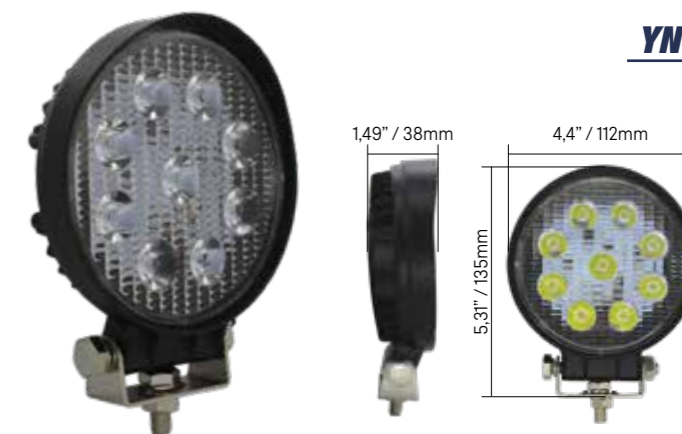

YN-FA0613



3.000 LM
MAIS LUMINOSIDADE

7.500 °K
LUZ BRANCA

20W
LUZ AZUL

FICHA TÉCNICA:

1 LEDs
DESC: FAROL AUXILIAR DE MOTO
TENSÃO OPERACIONAL: 12-80V DC
MODULO LED: 3W I PCS CREE LEDS
MATERIAL DA LENTE: PC
FEIXE: SPOT. FLOOD, COMBO
RESISTÊNCIA À ÁGUA: IP65
MATERIAL DA CAIXA: LATÃO
TEMPO DE VIDA: 30.000 HORAS
LINHA LEVE E PESADA

FICHA TÉCNICA:

9 LEDs
DESC: FAROL AUXILIAR AZUL
TENSÃO OPERACIONAL: 12-24V DC
MODULO LED: 3W I PCS CREE LEDS
MATERIAL DA LENTE: PC
FEIXE: SPOT. FLOOD, COMBO
RESISTÊNCIA À ÁGUA: IP67 (Submersível)
MATERIAL DA CAIXA: LATÃO
TEMPO DE VIDA: 30.000 HORAS
LINHA LEVE E PESADA

550 LM
MAIS LUMINOSIDADE

7.000 °K
LUZ BRANCA

27W
LUZ AZUL

YN-FA1509



YN-FA1329



3.000 LM
MAIS LUMINOSIDADE

7.500 °K
LUZ BRANCA

20W
LUZ AZUL

FICHA TÉCNICA:

1 LEDs
DESC: FAROL AUXILIAR DE MOTO
TENSÃO OPERACIONAL: 12-80V DC
MODULO LED: 3W I PCS CREE LEDS
MATERIAL DA LENTE: PC
FEIXE: SPOT. FLOOD, COMBO
RESISTÊNCIA À ÁGUA: IP65
MATERIAL DA CAIXA: LATÃO
TEMPO DE VIDA: 30.000 HORAS
LINHA LEVE E PESADA

FICHA TÉCNICA:

ALTO/BAIXO
DESC: FAROL AUXILIAR AZUL
TENSÃO OPERACIONAL: 12-24V DC
MODULO LED: 3W I PCS CREE LEDS
MATERIAL DA LENTE: PC
FEIXE: SPOT. FLOOD, COMBO
RESISTÊNCIA À ÁGUA: IP67 (Submersível)
MATERIAL DA CAIXA: LATÃO
TEMPO DE VIDA: 30.000 HORAS
LINHA LEVE E PESADA

3.000 LM ALTO
1.500 LM BAIXO

7.000 °K
LUZ BRANCA

30W ALTO
LUZ AZUL

15W BAIXO
LUZ AZUL

YN-FA1512



YN-FA1330

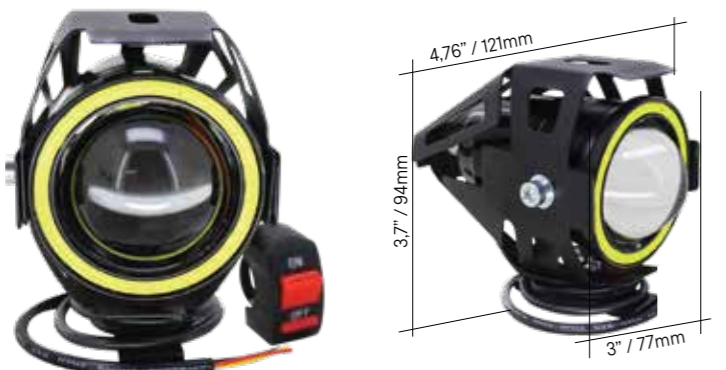

3.000 LM
MAIS LUMINOSIDADE

6.000 °K
LUZ BRANCA

20W
LUZ BRANCA

FICHA TÉCNICA:

1 LEDs
DESC: FAROL AUXILIAR DE MOTO
TENSÃO OPERACIONAL: 12-80V DC
MODULO LED: 3W I PCS CREE LEDS
MATERIAL DA LENTE: PC
FEIXE: SPOT. FLOOD, COMBO
RESISTÊNCIA À ÁGUA: IP65
MATERIAL DA CAIXA: LATÃO
TEMPO DE VIDA: 30.000 HORAS
LINHA LEVE E PESADA

FICHA TÉCNICA:

24 LEDs
DESC: FAROL AUXILIAR AZUL
TENSÃO OPERACIONAL: 12-24V DC
MODULO LED: 3W I PCS CREE LEDS
MATERIAL DA LENTE: PC
FEIXE: SPOT. FLOOD, COMBO
RESISTÊNCIA À ÁGUA: IP67 (Submersível)
MATERIAL DA CAIXA: LATÃO
TEMPO DE VIDA: 30.000 HORAS
LINHA LEVE E PESADA

3.600 LM
MAIS LUMINOSIDADE

7.000 °K
LUZ BRANCA

72W
LUZ AZUL

3.600 LM
MAIS LUMINOSIDADE

7.000 °K
LUZ BRANCA

72W
LUZ BRANCA

YN-FA1514



YN-FA1516

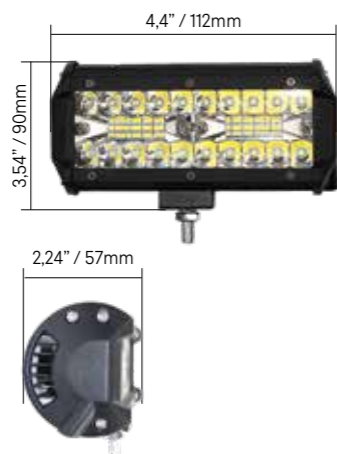

3.600 LM MAIS LUMINOSIDADE	6.000 LM MAIS LUMINOSIDADE
7.000 °K LUZ BRANCA	6.500 °K LUZ BRANCA
120W LUZ BRANCA	120W LUZ AZUL

FICHA TÉCNICA:

40 LEDs
DESC: FAROL AUXILIAR AZUL
TENSÃO OPERACIONAL: 12-24V DC
MODULO LED: 3W I PCS CREE LEDS
MATERIAL DA LENTE: PC
FEIXE: SPOT, FLOOD, COMBO
RESISTÊNCIA À ÁGUA: IP67 (Submersível)
MATERIAL DA CAIXA: LATÃO
TEMPO DE VIDA: 30.000 HORAS
LINHA LEVE E PESADA

FICHA TÉCNICA:

144 LEDs
DESC: FAROL AUXILIAR AZUL
TENSÃO OPERACIONAL: 12-30V DC
MODULO LED: 3W I PCS CREE LEDS
MATERIAL DA LENTE: PC
FEIXE: SPOT, FLOOD, COMBO
RESISTÊNCIA À ÁGUA: IP67 (Submersível)
MATERIAL DA CAIXA: LATÃO
TEMPO DE VIDA: 30.000 HORAS
LINHA LEVE E PESADA

21.600 LM MAIS LUMINOSIDADE
7.000 °K LUZ BRANCA
432W LUZ BRANCA



YN-FA1520

YN-FA1517



3.600 LM MAIS LUMINOSIDADE	3.600 LM MAIS LUMINOSIDADE
7.000 °K LUZ BRANCA	6.500 °K LUZ BRANCA
72W LUZ BRANCA	72W LUZ AZUL

FICHA TÉCNICA:

12 LEDs
DESC: FAROL AUXILIAR AZUL
TENSÃO OPERACIONAL: 12-24V DC
MODULO LED: 3W I PCS CREE LEDS
MATERIAL DA LENTE: PC
FEIXE: SPOT, FLOOD, COMBO
RESISTÊNCIA À ÁGUA: IP67
MATERIAL DA CAIXA: LATÃO
TEMPO DE VIDA: 30.000 HORAS
LINHA LEVE E PESADA

FICHA TÉCNICA:

42 LEDs
DESC: FAROL AUXILIAR BARRA
TENSÃO OPERACIONAL: 12-24V DC
MODULO LED: 3W I PCS CREE LEDS
MATERIAL DA LENTE: PC
FEIXE: SPOT, FLOOD
RESISTÊNCIA À ÁGUA: IP67
MATERIAL DA CAIXA: ALUMÍNIO
TEMPO DE VIDA: 30.000 HORAS
LINHA LEVE E PESADA

6.300 LM MAIS LUMINOSIDADE
7.000 °K LUZ BRANCA
126W LUZ BRANCA



YN-FA1595

YN-FA1518



7.200 LM MAIS LUMINOSIDADE	7.200 LM MAIS LUMINOSIDADE
7.000 °K LUZ BRANCA	7.000 °K LUZ BRANCA
144W LUZ BRANCA	144W LUZ AZUL

FICHA TÉCNICA:

48 LEDs
DESC: FAROL AUXILIAR AZUL
TENSÃO OPERACIONAL: 12-24V DC
MODULO LED: 3W I PCS CREE LEDS
MATERIAL DA LENTE: PC
FEIXE: SPOT, FLOOD, COMBO
RESISTÊNCIA À ÁGUA: IP67
MATERIAL DA CAIXA: ALUMÍNIO
TEMPO DE VIDA: 30.000 HORAS
LINHA LEVE E PESADA

FICHA TÉCNICA:

9 LEDs
DESC: FAROL AUXILIAR BARRA
TENSÃO OPERACIONAL: 9-30V DC
MODULO LED: 3W I PCS CREE LEDS
MATERIAL DA LENTE: PC
FEIXE: SPOT, FLOOD
RESISTÊNCIA À ÁGUA: IP67
MATERIAL DA CAIXA: ALUMÍNIO
TEMPO DE VIDA: 30.000 HORAS
LINHA LEVE E PESADA

1.800 LM MAIS LUMINOSIDADE
6.500 °K LUZ BRANCA
18W LUZ BRANCA



YN-FA1596

YN-FA1519



10.800 LM MAIS LUMINOSIDADE	10.800 LM MAIS LUMINOSIDADE
7.000 °K LUZ BRANCA	7.000 °K LUZ BRANCA
216W LUZ BRANCA	216W LUZ AZUL

FICHA TÉCNICA:

72 LEDs
DESC: FAROL AUXILIAR BARRA
TENSÃO OPERACIONAL: 12-24V DC
MODULO LED: 3W I PCS CREE LEDS
MATERIAL DA LENTE: PC
FEIXE: SPOT, FLOOD
RESISTÊNCIA À ÁGUA: IP67
MATERIAL DA CAIXA: ALUMÍNIO
TEMPO DE VIDA: 30.000 HORAS
LINHA LEVE E PESADA

FICHA TÉCNICA:

9 LEDs
DESC: FAROL AUXILIAR BARRA
TENSÃO OPERACIONAL: 9-30V DC
MODULO LED: 3W I PCS CREE LEDS
MATERIAL DA LENTE: PC
FEIXE: SPOT, FLOOD
RESISTÊNCIA À ÁGUA: IP67
MATERIAL DA CAIXA: ALUMÍNIO
TEMPO DE VIDA: 30.000 HORAS
LINHA LEVE E PESADA

1.800 LM MAIS LUMINOSIDADE
6.500 °K LUZ BRANCA
18W LUZ BRANCA

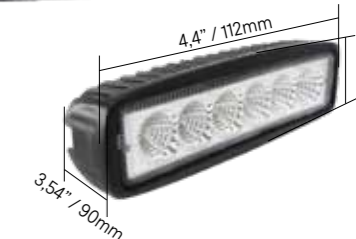

YN-FA1603

YN-FA1604



2.880 LM
MAIS LUMINOSIDADE

7.000 °K
LUZ BRANCA

96W
LUZ BRANCA

FICHA TÉCNICA:

18 LEDs
DESC: FAROL AUXILIAR
TENSÃO OPERACIONAL: 9-30V DC
MODULO LED: 3W I PCS CREE LEDS
MATERIAL DA LENTE: PC
FEIXE: SPOT, FLOOD, COMBO
RESISTÊNCIA À ÁGUA: IP67 (Submersível)
MATERIAL DA CAIXA: LATÃO
TEMPO DE VIDA: 30.000 HORAS
LINHA LEVE E PESADA

FICHA TÉCNICA:

9 LEDs
DESC: FAROL AUXILIAR BARRA
TENSÃO OPERACIONAL: 12-24V DC
MODULO LED: 3W I PCS CREE LEDS
MATERIAL DA LENTE: POLICARBONATO
FEIXE: SPOT, FLOOD
RESISTÊNCIA À ÁGUA: IP67
MATERIAL DA CAIXA: LATÃO
TEMPO DE VIDA: 30.000 HORAS
LINHA LEVE E PESADA

2.520 LM
MAIS LUMINOSIDADE

7.000 °K
LUZ BRANCA

27W
LUZ BRANCA



VL-FA1846

VL-F1798



2.880 LM
MAIS LUMINOSIDADE

7.000 °K
LUZ BRANCA

48W
LUZ BRANCA

FICHA TÉCNICA:

18 LEDs
DESC: FAROL AUXILIAR
TENSÃO OPERACIONAL: 10-30V DC
MODULO LED: 3W I PCS CREE LEDS
MATERIAL DA LENTE: POLICARBONATO
FEIXE: SPOT, FLOOD, COMBO
RESISTÊNCIA À ÁGUA: IP67 (Submersível)
MATERIAL DA CAIXA: LATÃO
TEMPO DE VIDA: 30.000 HORAS
LINHA LEVE E PESADA

FICHA TÉCNICA:

24 LEDs
DESC: FAROL AUXILIAR BARRA
TENSÃO OPERACIONAL: 9-36V DC
MODULO LED: 3W I PCS CREE LEDS
MATERIAL DA LENTE: POLICARBONATO
FEIXE: SPOT, FLOOD
RESISTÊNCIA À ÁGUA: IP67
MATERIAL DA CAIXA: LATÃO
TEMPO DE VIDA: 30.000 HORAS
LINHA LEVE E PESADA

6.000 LM
MAIS LUMINOSIDADE

7.000 °K
LUZ BRANCA

72W
LUZ BRANCA

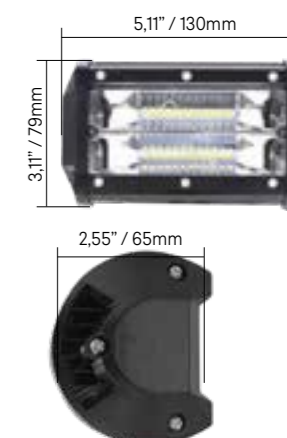

VL-FA1852

VL-F1799



2.880 LM
MAIS LUMINOSIDADE

7.000 °K
LUZ BRANCA

48W
LUZ BRANCA

FICHA TÉCNICA:

18 LEDs
DESC: FAROL AUXILIAR
TENSÃO OPERACIONAL: 10-30V DC
MODULO LED: 3W I PCS CREE LEDS
MATERIAL DA LENTE: POLICARBONATO
FEIXE: SPOT, FLOOD, COMBO
RESISTÊNCIA À ÁGUA: IP67 (Submersível)
MATERIAL DA CAIXA: LATÃO
TEMPO DE VIDA: 30.000 HORAS
LINHA LEVE E PESADA

FICHA TÉCNICA:

48 LEDs
DESC: FAROL AUXILIAR BARRA
TENSÃO OPERACIONAL: 9-36V DC
MODULO LED: 3W I PCS CREE LEDS
MATERIAL DA LENTE: POLICARBONATO
FEIXE: SPOT, FLOOD
RESISTÊNCIA À ÁGUA: IP67
MATERIAL DA CAIXA: LATÃO
TEMPO DE VIDA: 30.000 HORAS
LINHA LEVE E PESADA

6.000 LM
MAIS LUMINOSIDADE

7.000 °K
LUZ BRANCA

144W
LUZ BRANCA



VL-FA1853

VL-FA1845



2.880 LM
MAIS LUMINOSIDADE

7.000 °K
LUZ BRANCA

48W
LUZ BRANCA

FICHA TÉCNICA:

16 LEDs
DESC: FAROL AUXILIAR BARRA
TENSÃO OPERACIONAL: 12-24V DC
MODULO LED: 3W I PCS CREE LEDS
MATERIAL DA LENTE: POLICARBONATO
FEIXE: SPOT, FLOOD
RESISTÊNCIA À ÁGUA: IP67
MATERIAL DA CAIXA: LATÃO
TEMPO DE VIDA: 30.000 HORAS
LINHA LEVE E PESADA

FICHA TÉCNICA:

20 LEDs
DESC: FAROL AUXILIAR BARRA
TENSÃO OPERACIONAL: 9-36V DC
MODULO LED: 3W I PCS CREE LEDS
MATERIAL DA LENTE: POLICARBONATO
FEIXE: SPOT, FLOOD
RESISTÊNCIA À ÁGUA: IP67
MATERIAL DA CAIXA: LATÃO
TEMPO DE VIDA: 30.000 HORAS
LINHA LEVE E PESADA

6.000 LM
MAIS LUMINOSIDADE

7.000 °K
LUZ BRANCA

60W
LUZ BRANCA

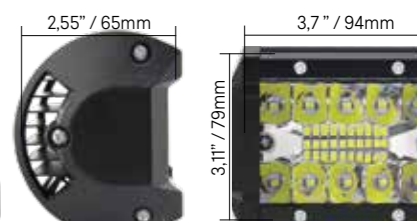

VL-FA1854

VL-FA1855



10.000 LM
MAIS LUMINOSIDADE

7.000 °K
LUZ BRANCA

120W
LUZ BRANCA

FICHA TÉCNICA:

40 LEDs
DESC: FAROL AUXILIAR BARRA
TENSÃO OPERACIONAL: 9-36V DC
MODULO LED: 3W I PCS CREE LEDS
MATERIAL DA LENTE: POLICARBONATO
FEIXE: SPOT. FLOOD
RESISTÊNCIA À ÁGUA: IP67
MATERIAL DA CAIXA: LATÃO
TEMPO DE VIDA: 30.000 HORAS
LINHA LEVE E PESADA

FICHA TÉCNICA:

18 LEDs
DESC: FAROL AUXILIAR BARRA
TENSÃO OPERACIONAL: 9-36V DC
MODULO LED: 3W I PCS CREE LEDS
MATERIAL DA LENTE: POLICARBONATO
FEIXE: SPOT. FLOOD
RESISTÊNCIA À ÁGUA: IP67
MATERIAL DA CAIXA: LATÃO
TEMPO DE VIDA: 30.000 HORAS
LINHA LEVE E PESADA

10.000 LM
MAIS LUMINOSIDADE

7.000 °K
LUZ BRANCA

54W
LUZ BRANCA

VL-FA1859

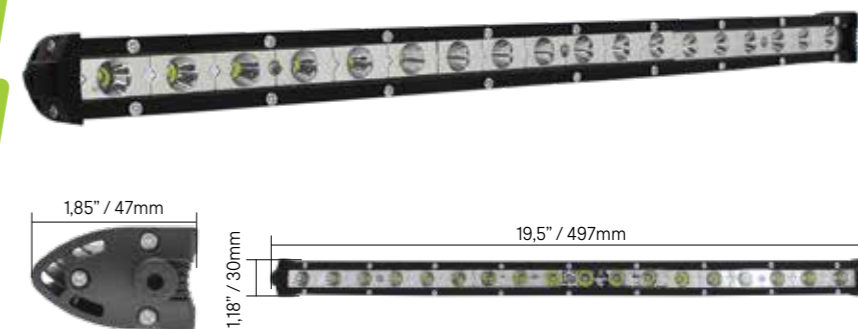

VL-FA1856



10.000 LM
MAIS LUMINOSIDADE

7.000 °K
LUZ BRANCA

216W
LUZ BRANCA

FICHA TÉCNICA:

72 LEDs
DESC: FAROL AUXILIAR BARRA
TENSÃO OPERACIONAL: 9-36V DC
MODULO LED: 3W I PCS CREE LEDS
MATERIAL DA LENTE: POLICARBONATO
FEIXE: SPOT. FLOOD
RESISTÊNCIA À ÁGUA: IP67
MATERIAL DA CAIXA: LATÃO
TEMPO DE VIDA: 30.000 HORAS
LINHA LEVE E PESADA

FICHA TÉCNICA:

48 LEDs
DESC: FAROL AUXILIAR BARRA
TENSÃO OPERACIONAL: 9-36V DC
MODULO LED: 3W I PCS CREE LEDS
MATERIAL DA LENTE: POLICARBONATO
FEIXE: SPOT. FLOOD
RESISTÊNCIA À ÁGUA: IP67
MATERIAL DA CAIXA: LATÃO
TEMPO DE VIDA: 30.000 HORAS
LINHA LEVE E PESADA

10.000 LM
MAIS LUMINOSIDADE

7.000 °K
LUZ BRANCA

54W
LUZ BRANCA

VL-FA1860



VL-FA1857



21.600 LM
MAIS LUMINOSIDADE

7.000 °K
LUZ BRANCA

432W
LUZ BRANCA

FICHA TÉCNICA:

40 LEDs
DESC: FAROL AUXILIAR BARRA
TENSÃO OPERACIONAL: 9-36V DC
MODULO LED: 3W I PCS CREE LEDS
MATERIAL DA LENTE: POLICARBONATO
FEIXE: SPOT. FLOOD
RESISTÊNCIA À ÁGUA: IP67
MATERIAL DA CAIXA: LATÃO
TEMPO DE VIDA: 30.000 HORAS
LINHA LEVE E PESADA

FICHA TÉCNICA:

48 LEDs
DESC: FAROL AUXILIAR BARRA
TENSÃO OPERACIONAL: 9-36V DC
MODULO LED: 3W I PCS CREE LEDS
MATERIAL DA LENTE: POLICARBONATO
FEIXE: SPOT. FLOOD
RESISTÊNCIA À ÁGUA: IP67
MATERIAL DA CAIXA: LATÃO
TEMPO DE VIDA: 30.000 HORAS
LINHA LEVE E PESADA

3.600 LM
MAIS LUMINOSIDADE

7.000 °K
LUZ BRANCA

54W
LUZ BRANCA

VL-FA1861



VL-FA1858

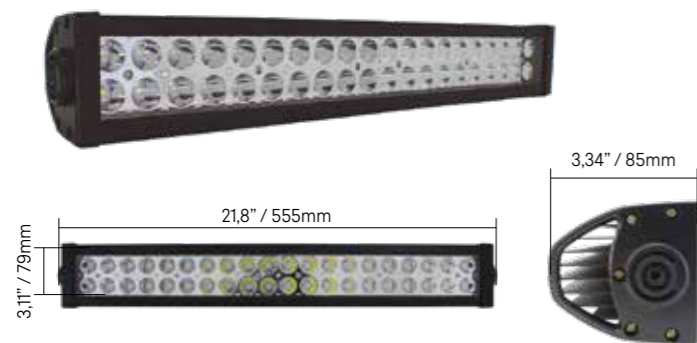

18.000 LM
MAIS LUMINOSIDADE

7.000 °K
LUZ BRANCA

120W
LUZ BRANCA

FICHA TÉCNICA:

40 LEDs
DESC: FAROL AUXILIAR BARRA
TENSÃO OPERACIONAL: 9-36V DC
MODULO LED: 3W I PCS CREE LEDS
MATERIAL DA LENTE: POLICARBONATO
FEIXE: SPOT. FLOOD
RESISTÊNCIA À ÁGUA: IP67
MATERIAL DA CAIXA: LATÃO
TEMPO DE VIDA: 30.000 HORAS
LINHA LEVE E PESADA





FAROL DE MILHA AVULSO E KITS

FAROL DE MILHA AVULSO E KITS

YN-FMU1426 XENON



MODELO ANO
 AGILE 09/13
 MONTANA 12/20
 VECTRA 06/11

H3
 ENCAIXE

FICHA TÉCNICA:

ESQUERDO

DESC: FAROL AUXILIAR AVULSO
 TENSÃO OPERACIONAL: 12V DC
 POSIÇÃO DA LUZ: FAROL AUXILIAR
 FONTE DE LUZ: H3 12V/55W
 MATERIAL DA LENTE: VIDRO
 MATERIAL DA CARÇAÇA: ABS
 SUPORTE: AÇO
 APROVADO NORMA ECE
 PESO: 1.200g

55W
 CONSUMO

YN-FMU1427 XENON



MODELO ANO
 AGILE 09/13
 MONTANA 12/20
 VECTRA 06/11

H3
 ENCAIXE

FICHA TÉCNICA:

ESQUERDO

DESC: FAROL AUXILIAR AVULSO
 TENSÃO OPERACIONAL: 12V DC
 POSIÇÃO DA LUZ: FAROL AUXILIAR
 FONTE DE LUZ: H3 12V/55W
 MATERIAL DA LENTE: VIDRO
 MATERIAL DA CARÇAÇA: ABS
 SUPORTE: AÇO
 APROVADO NORMA ECE
 PESO: 1.200g

55W
 CONSUMO

YN-FMU1430 XENON



MODELO ANO
 CORSA CLASSIC 03/10

H3
 ENCAIXE

FICHA TÉCNICA:

ESQUERDO

DESC: FAROL AUXILIAR AVULSO
 TENSÃO OPERACIONAL: 12V DC
 POSIÇÃO DA LUZ: FAROL AUXILIAR
 FONTE DE LUZ: H3 12V/55W
 MATERIAL DA LENTE: VIDRO
 MATERIAL DA CARÇAÇA: ABS
 SUPORTE: AÇO
 APROVADO NORMA ECE
 PESO: 1.200g

55W
 CONSUMO

YN-FMU1431 XENON



MODELO ANO
 CORSA CLASSIC 03/10

H3
 ENCAIXE

FICHA TÉCNICA:

ESQUERDO

DESC: FAROL AUXILIAR AVULSO
 TENSÃO OPERACIONAL: 12V DC
 POSIÇÃO DA LUZ: FAROL AUXILIAR
 FONTE DE LUZ: H3 12V/55W
 MATERIAL DA LENTE: VIDRO
 MATERIAL DA CARÇAÇA: ABS
 SUPORTE: AÇO
 APROVADO NORMA ECE
 PESO: 1.200g

55W
 CONSUMO

YN-FMU1428 XENON



MODELO ANO
 CELTA 07/15
 PRISMA 06/15

H4
 ENCAIXE

FICHA TÉCNICA:

ESQUERDO

DESC: FAROL AUXILIAR AVULSO
 TENSÃO OPERACIONAL: 12V DC
 POSIÇÃO DA LUZ: FAROL AUXILIAR
 FONTE DE LUZ: H4 12V/55W
 MATERIAL DA LENTE: VIDRO
 MATERIAL DA CARÇAÇA: ABS
 SUPORTE: AÇO
 APROVADO NORMA ECE
 PESO: 1.200g

55W
 CONSUMO

YN-FMU1429 XENON



MODELO ANO
 CELTA 07/15
 PRISMA 06/12

H4
 ENCAIXE

FICHA TÉCNICA:

DIREITO

DESC: FAROL AUXILIAR AVULSO
 TENSÃO OPERACIONAL: 12V DC
 POSIÇÃO DA LUZ: FAROL AUXILIAR
 FONTE DE LUZ: H4 12V/55W
 MATERIAL DA LENTE: VIDRO
 MATERIAL DA CARÇAÇA: ABS
 SUPORTE: AÇO
 APROVADO NORMA ECE
 PESO: 1.200g

55W
 CONSUMO

YN-FMU1432 XENON



MODELO ANO
 NEW CIVIC 09/11

H11
 ENCAIXE

FICHA TÉCNICA:

ESQUERDO

DESC: FAROL AUXILIAR AVULSO
 TENSÃO OPERACIONAL: 12V DC
 POSIÇÃO DA LUZ: FAROL AUXILIAR
 FONTE DE LUZ: H11 12V/55W
 MATERIAL DA LENTE: VIDRO
 MATERIAL DA CARÇAÇA: ABS
 SUPORTE: AÇO
 APROVADO NORMA ECE
 PESO: 1.200g

55W
 CONSUMO

YN-FMU1433 XENON



MODELO ANO
 NEW CIVIC 09/11

H11
 ENCAIXE

FICHA TÉCNICA:

ESQUERDO

DESC: FAROL AUXILIAR AVULSO
 TENSÃO OPERACIONAL: 12V DC
 POSIÇÃO DA LUZ: FAROL AUXILIAR
 FONTE DE LUZ: H11 12V/55W
 MATERIAL DA LENTE: VIDRO
 MATERIAL DA CARÇAÇA: ABS
 SUPORTE: AÇO
 APROVADO NORMA ECE
 PESO: 1.200g

55W
 CONSUMO

YN-FMU1434 XENON

MODELO ANO
NEW CIVIC 2015



H11
ENCAIXE

FICHA TÉCNICA:

ESQUERDO

DESC: FAROL AUXILIAR AVULSO
TENSÃO OPERACIONAL: 12V DC
POSIÇÃO DA LUZ: FAROL AUXILIAR
FONTE DE LUZ: H11 12V/55W
MATERIAL DA LENTE: VIDRO
MATERIAL DA CARÇAÇA: ABS
SUPORTE: AÇO
APROVADO NORMA ECE
PESO: 1.200g

55W
CONSUMO

YN-FMU1435 XENON

MODELO ANO
NEW CIVIC 2015



H11
ENCAIXE

FICHA TÉCNICA:

ESQUERDO

DESC: FAROL AUXILIAR AVULSO
TENSÃO OPERACIONAL: 12V DC
POSIÇÃO DA LUZ: FAROL AUXILIAR
FONTE DE LUZ: H11 12V/55W
MATERIAL DA LENTE: VIDRO
MATERIAL DA CARÇAÇA: ABS
SUPORTE: AÇO
APROVADO NORMA ECE
PESO: 1.200g

55W
CONSUMO

YN-FMU1438 XENON

MODELO ANO
COROLLA 09/18



H11
ENCAIXE

FICHA TÉCNICA:

ESQUERDO

DESC: FAROL AUXILIAR AVULSO
TENSÃO OPERACIONAL: 12V DC
POSIÇÃO DA LUZ: FAROL AUXILIAR
FONTE DE LUZ: H11 12V/55W
MATERIAL DA LENTE: VIDRO
MATERIAL DA CARÇAÇA: ABS
SUPORTE: AÇO
APROVADO NORMA ECE
PESO: 1.200g

55W
CONSUMO

YN-FMU1439 XENON

MODELO ANO
COROLLA 09/18



H11
ENCAIXE

FICHA TÉCNICA:

ESQUERDO

DESC: FAROL AUXILIAR AVULSO
TENSÃO OPERACIONAL: 12V DC
POSIÇÃO DA LUZ: FAROL AUXILIAR
FONTE DE LUZ: H11 12V/55W
MATERIAL DA LENTE: VIDRO
MATERIAL DA CARÇAÇA: ABS
SUPORTE: AÇO
APROVADO NORMA ECE
PESO: 1.200g

55W
CONSUMO

YN-FMU1436 XENON

MODELO ANO
C3 09/12
C4 LOUNGE 15/17
CLIO 13/16
CITY 15/18
CIVIC 15/18
DUSTER 11/16
FIESTA/NEW 11/17
NEW FIT 15/18
NEW KA 14/16
OROCH 11/16
PEUGEOT 208 07/12
PEUGEOT 307 07/12
RANGER 13/16
RENEGADE 16/20
TRITON 11/16



H11
ENCAIXE

FICHA TÉCNICA:

ESQUERDO

DESC: FAROL AUXILIAR AVULSO
TENSÃO OPERACIONAL: 12V DC
POSIÇÃO DA LUZ: FAROL AUXILIAR
FONTE DE LUZ: H11 12V/55W
MATERIAL DA LENTE: ACRÍLICO
MATERIAL DA CARÇAÇA: ABS
SUPORTE: AÇO
APROVADO NORMA ECE
PESO: 1.200g

55W
CONSUMO

YN-FMU1437 XENON

MODELO ANO
C3 09/12
C4 LOUNGE 15/17
CLIO 13/16
CITY 15/18
CIVIC 15/18
DUSTER 11/16
FIESTA/NEW 11/17
NEW FIT 15/18
NEW KA 14/16
OROCH 11/16
PEUGEOT 208 07/12
PEUGEOT 307 07/12
RANGER 13/16
RENEGADE 16/20
TRITON 11/16



H11
ENCAIXE

FICHA TÉCNICA:

DIREITO

DESC: FAROL AUXILIAR AVULSO
TENSÃO OPERACIONAL: 12V DC
POSIÇÃO DA LUZ: FAROL AUXILIAR
FONTE DE LUZ: H11 12V/55W
MATERIAL DA LENTE: VIDRO
MATERIAL DA CARÇAÇA: ABS
SUPORTE: AÇO
APROVADO NORMA ECE
PESO: 1.200g

55W
CONSUMO

YN-FMU1440 XENON

MODELO ANO
ETIOS 12/13



H16
ENCAIXE

FICHA TÉCNICA:

ESQUERDO

DESC: FAROL AUXILIAR AVULSO
TENSÃO OPERACIONAL: 12V DC
POSIÇÃO DA LUZ: FAROL AUXILIAR
FONTE DE LUZ: H16 12V/55W
MATERIAL DA LENTE: VIDRO
MATERIAL DA CARÇAÇA: ABS
SUPORTE: AÇO
APROVADO NORMA ECE
PESO: 1.200g

55W
CONSUMO

YN-FMU1441 XENON

MODELO ANO
ETIOS 12/13



H16
ENCAIXE

FICHA TÉCNICA:

ESQUERDO

DESC: FAROL AUXILIAR AVULSO
TENSÃO OPERACIONAL: 12V DC
POSIÇÃO DA LUZ: FAROL AUXILIAR
FONTE DE LUZ: H16 12V/55W
MATERIAL DA LENTE: VIDRO
MATERIAL DA CARÇAÇA: ABS
SUPORTE: AÇO
APROVADO NORMA ECE
PESO: 1.200g

55W
CONSUMO

YN-FMU1442 XENON



MODELO	ANO
CITROEN JUMPER	05>14
DUCATO	05>16
FIAT BRAVA	TODOS
IDEA	TODOS
MAREA	TODOS
PALIO	TODOS
PEUGEOT BOXER	05>14
PUNTO	TODOS
UNO	TODOS

H1
ENCAIXE

FICHA TÉCNICA:

ESQUERDO

DESC: FAROL AUXILIAR AVULSO
TENSÃO OPERACIONAL: 12V DC
POSIÇÃO DA LUZ: FAROL AUXILIAR
FONTE DE LUZ: H1 12V/55W
MATERIAL DA LENTE: VIDRO
MATERIAL DA CARÇAÇA: ABS
SUPORTE: AÇO
APROVADO NORMA ECE
PESO: 1.200g

55W
CONSUMO

YN-FMU1443 XENON



MODELO	ANO
CITROEN JUMPER	05>14
DUCATO	05>16
FIAT BRAVA	TODOS
IDEA	TODOS
MAREA	TODOS
PALIO	TODOS
PEUGEOT BOXER	05>14
PUNTO	TODOS
UNO	TODOS

H1
ENCAIXE

FICHA TÉCNICA:

ESQUERDO

DESC: FAROL AUXILIAR AVULSO
TENSÃO OPERACIONAL: 12V DC
POSIÇÃO DA LUZ: FAROL AUXILIAR
FONTE DE LUZ: H1 12V/55W
MATERIAL DA LENTE: VIDRO
MATERIAL DA CARÇAÇA: ABS
SUPORTE: AÇO
APROVADO NORMA ECE
PESO: 1.200g

55W
CONSUMO

YN-FMU1446 XENON



MODELO	ANO
GOL G4	06>13
PARATI G4	06>13
FOX	03>09
SPACEFOX	06>09
CROSSFOX	06>09
POLO HATCH	03>07
POLO SEDAN	03>07
SAVEIRO G4	06>10

H3
ENCAIXE

FICHA TÉCNICA:

ESQUERDO

DESC: FAROL AUXILIAR AVULSO
TENSÃO OPERACIONAL: 12V DC
POSIÇÃO DA LUZ: FAROL AUXILIAR
FONTE DE LUZ: H3 12V/55W
MATERIAL DA LENTE: VIDRO
MATERIAL DA CARÇAÇA: ABS
SUPORTE: AÇO
APROVADO NORMA ECE
PESO: 1.200g

55W
CONSUMO

YN-FMU1447 XENON



MODELO	ANO
GOL G4	06>13
PARATI G4	06>13
FOX	03>09
SPACEFOX	06>09
CROSSFOX	06>09
POLO HATCH	03>07
POLO SEDAN	03>07
SAVEIRO G4	06>10

H3
ENCAIXE

FICHA TÉCNICA:

ESQUERDO

DESC: FAROL AUXILIAR AVULSO
TENSÃO OPERACIONAL: 12V DC
POSIÇÃO DA LUZ: FAROL AUXILIAR
FONTE DE LUZ: H3 12V/55W
MATERIAL DA LENTE: VIDRO
MATERIAL DA CARÇAÇA: ABS
SUPORTE: AÇO
APROVADO NORMA ECE
PESO: 1.200g

55W
CONSUMO

YN-FMU1444 XENON



MODELO	ANO
GOL G4	06>13
PARATI G4	06>13
FOX	03>09
SPACEFOX	06>09
CROSSFOX	06>09
POLO HATCH	03>07
POLO SEDAN	03>07
SAVEIRO G4	06>10

H3
ENCAIXE

FICHA TÉCNICA:

ESQUERDO

DESC: FAROL AUXILIAR AVULSO
TENSÃO OPERACIONAL: 12V DC
POSIÇÃO DA LUZ: FAROL AUXILIAR
FONTE DE LUZ: H3 12V/55W
MATERIAL DA LENTE: VIDRO
MATERIAL DA CARÇAÇA: ABS
SUPORTE: AÇO
APROVADO NORMA ECE
PESO: 1.200g

55W
CONSUMO

YN-FMU1445 XENON



MODELO	ANO
GOL G4	06>13
PARATI G4	06>13
FOX	03>09
SPACEFOX	06>09
CROSSFOX	06>09
POLO HATCH	03>07
POLO SEDAN	03>07
SAVEIRO G4	06>10

H3
ENCAIXE

FICHA TÉCNICA:

DIREITO

DESC: FAROL AUXILIAR AVULSO
TENSÃO OPERACIONAL: 12V DC
POSIÇÃO DA LUZ: FAROL AUXILIAR
FONTE DE LUZ: H3 12V/55W
MATERIAL DA LENTE: VIDRO
MATERIAL DA CARÇAÇA: ABS
SUPORTE: AÇO
APROVADO NORMA ECE
PESO: 1.200g

55W
CONSUMO

YN-FMU1448 XENON



MODELO	ANO
AGILE	14>
COBALT	11>
ONIX	12>
PRISMA NOVO	13>
SONIC	11>
SPIN	12>

H27
ENCAIXE

FICHA TÉCNICA:

ESQUERDO

DESC: FAROL AUXILIAR AVULSO
TENSÃO OPERACIONAL: 12V DC
POSIÇÃO DA LUZ: FAROL AUXILIAR
FONTE DE LUZ: H27 12V/55W
MATERIAL DA LENTE: VIDRO
MATERIAL DA CARÇAÇA: ABS
SUPORTE: AÇO
APROVADO NORMA ECE
PESO: 1.200g

55W
CONSUMO

YN-FMU1449 XENON



MODELO	ANO
AGILE	14>
COBALT	11>
ONIX	12>
PRISMA NOVO	13>
SONIC	11>
SPIN	12>

H27
ENCAIXE

FICHA TÉCNICA:

ESQUERDO

DESC: FAROL AUXILIAR AVULSO
TENSÃO OPERACIONAL: 12V DC
POSIÇÃO DA LUZ: FAROL AUXILIAR
FONTE DE LUZ: H27 12V/55W
MATERIAL DA LENTE: VIDRO
MATERIAL DA CARÇAÇA: ABS
SUPORTE: AÇO
APROVADO NORMA ECE
PESO: 1.200g

55W
CONSUMO

YN-FM1416 XENON



MODELO ANO
COROLLA 12>13

H11
ENCAIXE

FICHA TÉCNICA:

ESQUERDO

DESC: FAROL AUXILIAR AVULSO
TENSÃO OPERACIONAL: 12V DC
POSIÇÃO DA LUZ: FAROL AUXILIAR
FONTE DE LUZ: H11 12V/55W
MATERIAL DA LENTE: VIDRO
MATERIAL DA CARÇAÇA: ABS
SUPORTE: AÇO
APROVADO NORMA ECE
PESO: 1.200g

55W
CONSUMO

YN-FM1417 XENON



MODELO ANO
207 06>10
307 06>10
HOGGAR 06>10
LOGAN 15>
RENEGADE 19>
SANDERO 11>

H11
ENCAIXE

FICHA TÉCNICA:

ESQUERDO

DESC: FAROL AUXILIAR AVULSO
TENSÃO OPERACIONAL: 12V DC
POSIÇÃO DA LUZ: FAROL AUXILIAR
FONTE DE LUZ: H11 12V/55W
MATERIAL DA LENTE: VIDRO
MATERIAL DA CARÇAÇA: ABS
SUPORTE: AÇO
APROVADO NORMA ECE
PESO: 1.200g

55W
CONSUMO

YN-FM1423 XENON



MODELO ANO
FOX 10>13
SPACEFOX 10>13

H4
ENCAIXE

FICHA TÉCNICA:

ESQUERDO

DESC: FAROL AUXILIAR AVULSO
TENSÃO OPERACIONAL: 12V DC
POSIÇÃO DA LUZ: FAROL AUXILIAR
FONTE DE LUZ: H4 12V/55W
MATERIAL DA LENTE: VIDRO
MATERIAL DA CARÇAÇA: ABS
SUPORTE: AÇO
APROVADO NORMA ECE
PESO: 1.200g

55W
CONSUMO

YN-FM1247 XENON



MODELO ANO
GOL 06>09
PARATI 06>09
SAVEIRO 06>09

H3
ENCAIXE

FICHA TÉCNICA:

ESQUERDO

DESC: FAROL AUXILIAR AVULSO
TENSÃO OPERACIONAL: 12V DC
POSIÇÃO DA LUZ: FAROL AUXILIAR
FONTE DE LUZ: H3 12V/55W
MATERIAL DA LENTE: VIDRO
MATERIAL DA CARÇAÇA: ABS
SUPORTE: AÇO
APROVADO NORMA ECE
PESO: 1.200g

55W
CONSUMO

YN-FM1418 XENON



MODELO ANO
DUSTER 15>21

H11
ENCAIXE

FICHA TÉCNICA:

ESQUERDO

DESC: FAROL AUXILIAR AVULSO
TENSÃO OPERACIONAL: 12V DC
POSIÇÃO DA LUZ: FAROL AUXILIAR
FONTE DE LUZ: H11 12V/55W
MATERIAL DA LENTE: VIDRO
MATERIAL DA CARÇAÇA: ABS
SUPORTE: AÇO
APROVADO NORMA ECE
PESO: 1.200g

55W
CONSUMO

YN-FM1419 XENON



MODELO ANO
KWID 17>

H11
ENCAIXE

FICHA TÉCNICA:

DIREITO

DESC: FAROL AUXILIAR AVULSO
TENSÃO OPERACIONAL: 12V DC
POSIÇÃO DA LUZ: FAROL AUXILIAR
FONTE DE LUZ: H11 12V/55W
MATERIAL DA LENTE: VIDRO
MATERIAL DA CARÇAÇA: ABS
SUPORTE: AÇO
APROVADO NORMA ECE
PESO: 1.200g

55W
CONSUMO

YN-FM1248 XENON



MODELO ANO
FOX 03>09
CROSSFOX 03>09

H3
ENCAIXE

FICHA TÉCNICA:

ESQUERDO

DESC: FAROL AUXILIAR AVULSO
TENSÃO OPERACIONAL: 12V DC
POSIÇÃO DA LUZ: FAROL AUXILIAR
FONTE DE LUZ: H3 12V/55W
MATERIAL DA LENTE: VIDRO
MATERIAL DA CARÇAÇA: ABS
SUPORTE: AÇO
APROVADO NORMA ECE
PESO: 1.200g

55W
CONSUMO

YN-FM1249 XENON



MODELO ANO
GOL 19>
GOL TRACK 17>
ROBUST 16>
TRENDLINE 16>

H8
ENCAIXE

FICHA TÉCNICA:

ESQUERDO

DESC: FAROL AUXILIAR AVULSO
TENSÃO OPERACIONAL: 12V DC
POSIÇÃO DA LUZ: FAROL AUXILIAR
FONTE DE LUZ: H8 12V/55W
MATERIAL DA LENTE: VIDRO
MATERIAL DA CARÇAÇA: ABS
SUPORTE: AÇO
APROVADO NORMA ECE
PESO: 1.200g

55W
CONSUMO

YN-FM1250 XENON



MODELO	ANO
ECOSPORT	08>12
FIESTA	07>10
KA	08>11

H4

ENCAIXE

FICHA TÉCNICA:

ESQUERDO

DESC: FAROL AUXILIAR AVULSO
TENSÃO OPERACIONAL: 12V DC
POSIÇÃO DA LUZ: FAROL AUXILIAR
FONTE DE LUZ: H4 12V/55W
MATERIAL DA LENTE: VIDRO
MATERIAL DA CARÇAÇA: ABS
SUPORTE: AÇO
APROVADO NORMA ECE
PESO: 1.200g



55W

CONSUMO

YN-FM1251 XENON



MODELO	ANO
CLASSIC	03>10
CORSA	00>02
CORSA PICK UP	00>02

H3

ENCAIXE

FICHA TÉCNICA:

ESQUERDO

DESC: FAROL AUXILIAR AVULSO
TENSÃO OPERACIONAL: 12V DC
POSIÇÃO DA LUZ: FAROL AUXILIAR
FONTE DE LUZ: H3 12V/55W
MATERIAL DA LENTE: VIDRO
MATERIAL DA CARÇAÇA: ABS
SUPORTE: AÇO
APROVADO NORMA ECE
PESO: 1.200g



55W

CONSUMO

YN-FM1254 XENON



MODELO	ANO
COBALT	12>19
PRISMA NOVO	12>19
ONIX	12>19
S10	16>19
SPIN	12>19
SONIC	12>19

H27

ENCAIXE

FICHA TÉCNICA:

ESQUERDO

DESC: FAROL AUXILIAR AVULSO
TENSÃO OPERACIONAL: 12V DC
POSIÇÃO DA LUZ: FAROL AUXILIAR
FONTE DE LUZ: H27 12V/55W
MATERIAL DA LENTE: VIDRO
MATERIAL DA CARÇAÇA: ABS
SUPORTE: AÇO
APROVADO NORMA ECE
PESO: 1.200g



55W

CONSUMO

YN-FM1255 XENON



MODELO	ANO
ONIX JOY	17>
PRISMA JOY	17>

H27

ENCAIXE

FICHA TÉCNICA:

ESQUERDO

DESC: FAROL AUXILIAR AVULSO
TENSÃO OPERACIONAL: 12V DC
POSIÇÃO DA LUZ: FAROL AUXILIAR
FONTE DE LUZ: H27 12V/55W
MATERIAL DA LENTE: VIDRO
MATERIAL DA CARÇAÇA: ABS
SUPORTE: AÇO
APROVADO NORMA ECE
PESO: 1.200g



55W

CONSUMO

YN-FM1252 XENON



MODELO	ANO
CORSA	03>11
MERIVA	03>11
MONTANA	03>11

H3

ENCAIXE

FICHA TÉCNICA:

ESQUERDO

DESC: FAROL AUXILIAR AVULSO
TENSÃO OPERACIONAL: 12V DC
POSIÇÃO DA LUZ: FAROL AUXILIAR
FONTE DE LUZ: H3 12V/55W
MATERIAL DA LENTE: VIDRO
MATERIAL DA CARÇAÇA: ABS
SUPORTE: AÇO
APROVADO NORMA ECE
PESO: 1.200g



55W

CONSUMO

YN-FM1253 XENON



MODELO	ANO
CORSA	03>11
MERIVA	03>11
MONTANA	03>11

H3

ENCAIXE

FICHA TÉCNICA:

DIREITO

DESC: FAROL AUXILIAR AVULSO
TENSÃO OPERACIONAL: 12V DC
POSIÇÃO DA LUZ: FAROL AUXILIAR
FONTE DE LUZ: H3 12V/55W
MATERIAL DA LENTE: VIDRO
MATERIAL DA CARÇAÇA: ABS
SUPORTE: AÇO
APROVADO NORMA ECE
PESO: 1.200g



55W

CONSUMO

YN-FM1256 XENON



MODELO	ANO
CELTA	07>11
PRISMA	07>11

H4

ENCAIXE

FICHA TÉCNICA:

ESQUERDO

DESC: FAROL AUXILIAR AVULSO
TENSÃO OPERACIONAL: 12V DC
POSIÇÃO DA LUZ: FAROL AUXILIAR
FONTE DE LUZ: H4 12V/55W
MATERIAL DA LENTE: VIDRO
MATERIAL DA CARÇAÇA: ABS
SUPORTE: AÇO
APROVADO NORMA ECE
PESO: 1.200g



55W

CONSUMO

YN-FM1257 XENON



MODELO	ANO
CELTA	12>15
PRISMA	12>19

H4

ENCAIXE

FICHA TÉCNICA:

ESQUERDO

DESC: FAROL AUXILIAR AVULSO
TENSÃO OPERACIONAL: 12V DC
POSIÇÃO DA LUZ: FAROL AUXILIAR
FONTE DE LUZ: H4 12V/55W
MATERIAL DA LENTE: VIDRO
MATERIAL DA CARÇAÇA: ABS
SUPORTE: AÇO
APROVADO NORMA ECE
PESO: 1.200g



55W

CONSUMO

YN-FM1258 XENON



MODELO ANO
NEW CIVIC 09>11

H11
ENCAIXE

FICHA TÉCNICA:

ESQUERDO

DESC: FAROL AUXILIAR AVULSO
TENSÃO OPERACIONAL: 12V DC
POSIÇÃO DA LUZ: FAROL AUXILIAR
FONTE DE LUZ: H11 12V/55W
MATERIAL DA LENTE: VIDRO
MATERIAL DA CARÇAÇA: ABS
SUPORTE: AÇO
APROVADO NORMA ECE
PESO: 1.200g

55W
CONSUMO

YN-FM1259 XENON



MODELO ANO
NEW CIVIC 12>14

H11
ENCAIXE

FICHA TÉCNICA:

ESQUERDO

DESC: FAROL AUXILIAR AVULSO
TENSÃO OPERACIONAL: 12V DC
POSIÇÃO DA LUZ: FAROL AUXILIAR
FONTE DE LUZ: H11 12V/55W
MATERIAL DA LENTE: VIDRO
MATERIAL DA CARÇAÇA: ABS
SUPORTE: AÇO
APROVADO NORMA ECE
PESO: 1.200g

55W
CONSUMO

YN-FM1262 XENON



MODELO ANO
CLIO 13>
DUSTER 13>
LOGAN 06>11
OROCH 13>
SANDERO 07>11

H11
ENCAIXE

FICHA TÉCNICA:

ESQUERDO

DESC: FAROL AUXILIAR AVULSO
TENSÃO OPERACIONAL: 12V DC
POSIÇÃO DA LUZ: FAROL AUXILIAR
FONTE DE LUZ: H11 12V/55W
MATERIAL DA LENTE: VIDRO
MATERIAL DA CARÇAÇA: ABS
SUPORTE: AÇO
APROVADO NORMA ECE
PESO: 1.200g

55W
CONSUMO

YN-FM1263 XENON



MODELO ANO
PALIO ELX 11>
SIENA 11>
ELX 11>

H1
ENCAIXE

FICHA TÉCNICA:

ESQUERDO

DESC: FAROL AUXILIAR AVULSO
TENSÃO OPERACIONAL: 12V DC
POSIÇÃO DA LUZ: FAROL AUXILIAR
FONTE DE LUZ: H1 12V/55W
MATERIAL DA LENTE: VIDRO
MATERIAL DA CARÇAÇA: ABS
SUPORTE: AÇO
APROVADO NORMA ECE
PESO: 1.200g

55W
CONSUMO

YN-FM1260 XENON



MODELO ANO
COROLLA 12>13

H11
ENCAIXE

FICHA TÉCNICA:

ESQUERDO

DESC: FAROL AUXILIAR AVULSO
TENSÃO OPERACIONAL: 12V DC
POSIÇÃO DA LUZ: FAROL AUXILIAR
FONTE DE LUZ: H11 12V/55W
MATERIAL DA LENTE: VIDRO
MATERIAL DA CARÇAÇA: ABS
SUPORTE: AÇO
APROVADO NORMA ECE
PESO: 1.200g

55W
CONSUMO

YN-FM1261 XENON



MODELO ANO
ETIOS 12>

H16
ENCAIXE

FICHA TÉCNICA:

DIREITO

DESC: FAROL AUXILIAR AVULSO
TENSÃO OPERACIONAL: 12V DC
POSIÇÃO DA LUZ: FAROL AUXILIAR
FONTE DE LUZ: H16 12V/55W
MATERIAL DA LENTE: VIDRO
MATERIAL DA CARÇAÇA: ABS
SUPORTE: AÇO
APROVADO NORMA ECE
PESO: 1.200g

55W
CONSUMO

YN-FM1264 XENON



MODELO ANO
GOL 12>15
VOYAGE 12>15

H8
ENCAIXE

FICHA TÉCNICA:

ESQUERDO

DESC: FAROL AUXILIAR AVULSO
TENSÃO OPERACIONAL: 12V DC
POSIÇÃO DA LUZ: FAROL AUXILIAR
FONTE DE LUZ: H8 12V/55W
MATERIAL DA LENTE: VIDRO
MATERIAL DA CARÇAÇA: ABS
SUPORTE: AÇO
APROVADO NORMA ECE
PESO: 1.200g

55W
CONSUMO

YN-FM1265 XENON



MODELO ANO
FOX 14>

H4
ENCAIXE

FICHA TÉCNICA:

ESQUERDO

DESC: FAROL AUXILIAR AVULSO
TENSÃO OPERACIONAL: 12V DC
POSIÇÃO DA LUZ: FAROL AUXILIAR
FONTE DE LUZ: H4 12V/55W
MATERIAL DA LENTE: VIDRO
MATERIAL DA CARÇAÇA: ABS
SUPORTE: AÇO
APROVADO NORMA ECE
PESO: 1.200g

55W
CONSUMO

YN-FM1266 XENON



MODELO ANO
 GOL G3 99>02
 PARATI G3 99>02
 PARATI G3 99>02

H3
ENCAIXE

FICHA TÉCNICA:

ESQUERDO

DESC: FAROL AUXILIAR AVULSO
 TENSÃO OPERACIONAL: 12V DC
 POSIÇÃO DA LUZ: FAROL AUXILIAR
 FONTE DE LUZ: H3 12V/55W
 MATERIAL DA LENTE: VIDRO
 MATERIAL DA CARÇAÇA: ABS
 SUPORTE: AÇO
 APROVADO NORMA ECE
 PESO: 1.200g

55W
CONSUMO

YN-FM1267 XENON



MODELO ANO
 GOL G5 99>12
 SAVEIRO G5 99>12
 VOYAGE G5 99>12

H4
ENCAIXE

FICHA TÉCNICA:

ESQUERDO

DESC: FAROL AUXILIAR AVULSO
 TENSÃO OPERACIONAL: 12V DC
 POSIÇÃO DA LUZ: FAROL AUXILIAR
 FONTE DE LUZ: H4 12V/55W
 MATERIAL DA LENTE: VIDRO
 MATERIAL DA CARÇAÇA: ABS
 SUPORTE: AÇO
 APROVADO NORMA ECE
 PESO: 1.200g

55W
CONSUMO

YN-FM1422 XENON



MODELO ANO
 FOX 14>

H4
ENCAIXE

FICHA TÉCNICA:

ESQUERDO

DESC: FAROL AUXILIAR AVULSO
 TENSÃO OPERACIONAL: 12V DC
 POSIÇÃO DA LUZ: FAROL AUXILIAR
 FONTE DE LUZ: H4 12V/55W
 MATERIAL DA LENTE: VIDRO
 MATERIAL DA CARÇAÇA: ABS
 SUPORTE: AÇO
 APROVADO NORMA ECE
 PESO: 1.200g

55W
CONSUMO

YN-FM1424 XENON



MODELO ANO
 SAVEIRO TREND 13>
 TROPPER 13>

H4
ENCAIXE

FICHA TÉCNICA:

ESQUERDO

DESC: FAROL AUXILIAR AVULSO
 TENSÃO OPERACIONAL: 12V DC
 POSIÇÃO DA LUZ: FAROL AUXILIAR
 FONTE DE LUZ: H4 12V/55W
 MATERIAL DA LENTE: VIDRO
 MATERIAL DA CARÇAÇA: ABS
 SUPORTE: AÇO
 APROVADO NORMA ECE
 PESO: 1.200g

55W
CONSUMO

YN-FM1268 XENON



MODELO ANO
 AGILE 09>13
 MONTANA 12>16

H3
ENCAIXE

FICHA TÉCNICA:

ESQUERDO

DESC: FAROL AUXILIAR AVULSO
 TENSÃO OPERACIONAL: 12V DC
 POSIÇÃO DA LUZ: FAROL AUXILIAR
 FONTE DE LUZ: H3 12V/55W
 MATERIAL DA LENTE: VIDRO
 MATERIAL DA CARÇAÇA: ABS
 SUPORTE: AÇO
 APROVADO NORMA ECE
 PESO: 1.200g

55W
CONSUMO

YN-FM1420 XENON



MODELO ANO
 FOX 10>13
 SPACEFOX 10>13

H4
ENCAIXE

FICHA TÉCNICA:

DIREITO

DESC: FAROL AUXILIAR AVULSO
 TENSÃO OPERACIONAL: 12V DC
 POSIÇÃO DA LUZ: FAROL AUXILIAR
 FONTE DE LUZ: H4 12V/55W
 MATERIAL DA LENTE: VIDRO
 MATERIAL DA CARÇAÇA: ABS
 SUPORTE: AÇO
 APROVADO NORMA ECE
 PESO: 1.200g

55W
CONSUMO

YN-FM1425 XENON



MODELO ANO
 NEW FIESTA 13>16

H11
ENCAIXE

FICHA TÉCNICA:

ESQUERDO

DESC: FAROL AUXILIAR AVULSO
 TENSÃO OPERACIONAL: 12V DC
 POSIÇÃO DA LUZ: FAROL AUXILIAR
 FONTE DE LUZ: H11 12V/55W
 MATERIAL DA LENTE: VIDRO
 MATERIAL DA CARÇAÇA: ABS
 SUPORTE: AÇO
 APROVADO NORMA ECE
 PESO: 1.200g

55W
CONSUMO





D
PALHETAS

RAPIDEZA



14" - 28" PALHETAS ESPECÍFICAS



GENERAL MOTORS



YN-PR1196 | ENCAIXE **B**

MODELO	ANO
TRACKER	2014/2019

MOT. 26" PAX. 14"



YN-PR1198 | ENCAIXE **B**

MODELO	ANO
CRUZE/SPORT	2017,

MOT. 28" PAX. 13"



YN-PR1199 | ENCAIXE **F**

MODELO	ANO
COBALT	2011

MOT. 26" PAX. 16"

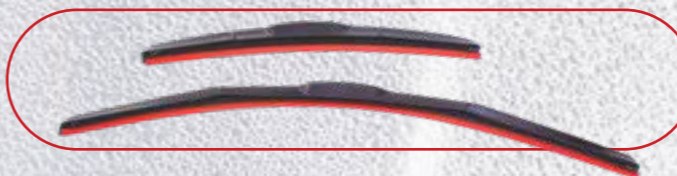
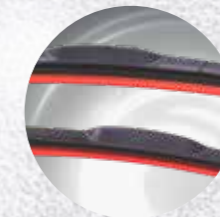

YN-PS2117B | ENCAIXE **B**

MODELO	ANO
MONTANA	2019/2024

MOT. 21" PAX. 17"



YN-PS2118D | **D**

MODELO	ANO
MONTANA AGILE	2011/2019 2011/2014

MOT. 22" PAX. 18"



YN-PS2414B | ENCAIXE **B**

MODELO	ANO
PRISMA ONIX	2018/2019 2019,

MOT. 22" PAX. 18"



Design simplificado
produzida em material
de qualidade excelente!

GENERAL MOTORS



YN-PS2416B | ENCAIXE **B**

MODELO	ANO
ONIX TRACKER	2019:2020 2020>

MOT. 24" PAX. 16"



YN-PS2615A | ENCAIXE **A**

MODELO	ANO
SONIC	2012/2014

MOT. 26" PAX. 15"



JEEP



YN-PR1197 | ENCAIXE **B**

MODELO	ANO
RENEGADE	2015

MOT. 13" PAX. 13"



YN-PS2220F | ENCAIXE **F**

MODELO	ANO
RENEGADE	2015/2024

MOT. 13" PAX. 13"



FORD



YN-PR1198 | ENCAIXE **B**

MODELO	ANO
FORD FOCUS	2014>

MOT. 28" PAX. 13"

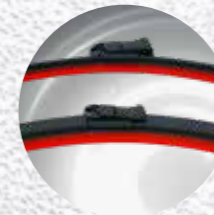

YN-PS1401 | ENCAIXE **B**

MODELO	ANO
RANGER	2017>

MOT. 24" PAX. 15"



YN-PS1917D | ENCAIXE **D**

MODELO	ANO
KA	2011/2013

MOT. 19" PAX. 17"



YN-PS2116A | ENCAIXE **A**

MODELO	ANO
FIESTA BRASILEIRO	2017>

MOT. 21" PAX. 16"



YN-PS2216D | ENCAIXE **D**

MODELO	ANO
ECOSPORT KA/KA+	2012/2017 2014>2021

MOT. 22" PAX. 16"



YN-PS2216F | ENCAIXE **F**

MODELO	ANO
ECOSPORT	2017>

MOT. 22" PAX. 16"



FORD



YN-PS2321B | ENCAIXE **B**

MODELO	ANO
BRONCO MAVERICK	2016/2024 2026/2024

MOT. 23" PAX. 21"



YN-PS2616E | ENCAIXE **E**

MODELO	ANO
X1	2016/2024

MOT. 25" PAX. 16"



YN-PS2617C | ENCAIXE **C**

MODELO	ANO
FOCUS	2008/2013

MOT. 26" PAX. 17"



YN-PS2826A | ENCAIXE **A**

MODELO	ANO
FUSION EDGE	2013,2019 2015,2020

MOT. 28" PAX. 26"

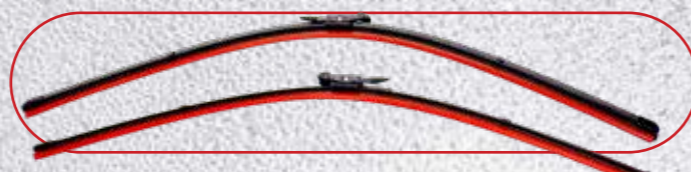

HYUNDAI



YN-PR1199 | ENCAIXE **B**

MODELO	ANO
CRETA ELANTRA	2017,2020

MOT. 26" PAX. 16"

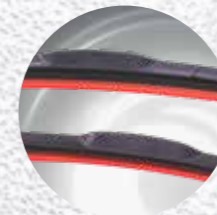

YN-PS2416F | ENCAIXE **F**

MODELO	ANO
CRETA HB20 PREMIUM	2021 2013,2019

MOT. 24" PAX. 16"



YN-PS2418B | ENCAIXE **B**

MODELO	ANO
I30 2.0	2008/2012

MOT. 24" PAX. 17"



YN-PS2419B | ENCAIXE **B**

MODELO	ANO
VERA CRUZ	2008/2012

MOT. 24" PAX. 16"



YN-PS2614F | ENCAIXE **F**

MODELO	ANO
CRETA	2017/2020

MOT. 26" PAX. 14"



YN-PS2618F | ENCAIXE **F**

MODELO	ANO
AZERA SONATA	2014/2024 2014/2024

MOT. 26" PAX. 18"

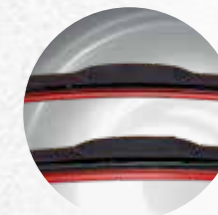

HONDA



YN-PR1196 | ENCAIXE **B**

MODELO	ANO
HR-V	2018>

MOT. 26" PAX. 14"



YN-PS2414B | ENCAIXE **B**

MODELO	ANO
CITY	2009/2014

MOT. 22" PAX. 18"



YN-PS2416B | ENCAIXE **B**

MODELO	ANO
CIVIC	2017>

MOT. 24" PAX. 16"



YN-PS2416F | ENCAIXE **F**

MODELO	ANO
FIT	2003/2008

MOT. 24" PAX. 16"



YN-PS2418B | ENCAIXE **B**

MODELO	ANO
ACCOR	2003/2012

MOT. 24" PAX. 17"



YN-PS2616E | ENCAIXE **E**

MODELO	ANO
CIVIC	2017/2024

MOT. 25" PAX. 16"



HONDA



YN-PS2616G | ENCAIXE **G**

MODELO	ANO
CRV	2013/2024

MOT. 26" PAX. 16"



YN-PS2624B | ENCAIXE **B**

MODELO	ANO
CIVIC	2007/2011

MOT. 26" PAX. 24"



KIA



YN-PR1199 | ENCAIXE **F**

MODELO	ANO
CARENS	2007/2012

MOT. 26" PAX. 16"



YN-PS2416F | ENCAIXE **F**

MODELO	ANO
CERATO SPORTAGE	2004/2009 2005/2010

MOT. 24" PAX. 16"



KIA



YN-PS2420F | ENCAIXE **F**

MODELO	ANO
QUORIS	2012/2015

MOT. 24" PAX. 20"



YN-PS2614F | ENCAIXE **F**

MODELO	ANO
CARENS	2010/2013
NIRO	2023/2024
STONIC	2022/2024

MOT. 26" PAX. 14"



YN-PS2617C | ENCAIXE **C**

MODELO	ANO
SPORTAGE	2022/2024

MOT. 26" PAX. 17"



LEXUS



YN-PR1199 | ENCAIXE **F**

MODELO	ANO
LS 430	2001/2002

MOT. 26" PAX. 16"



NISSAN



YN-PR1199 | ENCAIXE **F**

MODELO	ANO
MAXIMA	2001/2002

MOT. 24" PAX. 17"

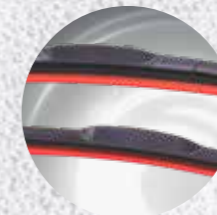

YN-PS2216F | ENCAIXE **F**

MODELO	ANO
TIIDA	2008/2013
TIIDA SEDAN	2011/2013

MOT. 22" PAX. 16"



NISSAN



YN-PS2416F | ENCAIXE **F**

MODELO	ANO
SENTRA II	2007/2013
MURANO	2007/2011
X-TRAIL	2001/2012

MOT. 24" PAX. 16"



CITROËN



YN-PS1394 | ENCAIXE **A**

MODELO	ANO
C5/C5 BREAK	2008/2024
C5 TOURER	2008/2024

MOT. 28" PAX. 21"

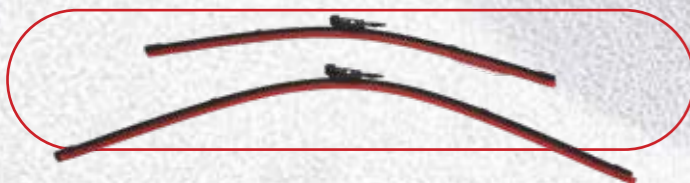

YN-PS1401 | ENCAIXE **B**

MODELO	ANO
AIRCROSS	2011/2014
C3	2011/2014

MOT. 24" PAX. 15"



CITROËN



YN-PS1403 | ENCAIXE **B**

MODELO	ANO
C4 LOUNGE	2014/2024
DS4	2013/2024

MOT. 30" PAX. 26"



YN-PS1524 | ENCAIXE **C**

MODELO	ANO
C5/C5 BREAK	2004/2007

MOT. 26" PAX. 18"



YN-PS2414B | ENCAIXE **B**

MODELO	ANO
C4 AIR CROSS	2011

MOT. 22" PAX. 18"

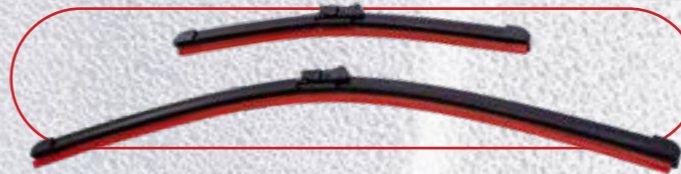

YN-PS2416B | ENCAIXE **B**

MODELO	ANO
C3 AIRCROSS	2011/2014
C3 PICASSO	2011/2014

MOT. 24" PAX. 16"



YN-PS2616H | ENCAIXE **H**

MODELO	ANO
C4 CACTUS	2018/2024

MOT. 26" PAX. 16"



YN-PS2824A | ENCAIXE **A**

MODELO	ANO
C4 HATCH	2009
C4 PALLAS	2005/2014

MOT. 28" PAX. 15"



CITROËN



YN-PS2826B | ENCAIXE **B**

MODELO	ANO
DS4	2014/2024
C4 LOUNGE	2014/2024

MOT. 24" PAX. 16"



YN-PS3030H | ENCAIXE **H**

MODELO	ANO
C4 PICASSO	2008/2014
GRAND C4	2008/2014

MOT. 28" PAX. 26"



RENAULT



YN-PR1199 | ENCAIXE **F**

MODELO	ANO
LAGUNA	1994/2000
SCENIC	1999/2004

MOT. 26" PAX. 16"

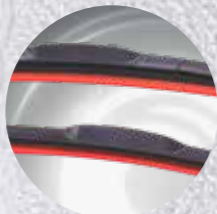

YN-PS2220H | ENCAIXE **H**

MODELO	ANO
SANDERO	2014/2024
LOGAN	2014/2024
DUSTER	2020/2024

MOT. 22" PAX. 20"



RENAULT



YN-PS2416F | ENCAIXE **F**

MODELO	ANO
FLUENCE	2015>

MOT. 24" PAX. 17"

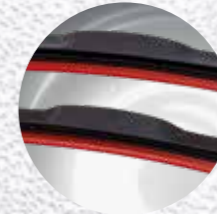

SUBARU



YN-PR1199 | ENCAIXE **F**

MODELO	ANO
FORESTER	2013>

MOT. 26" PAX. 14"

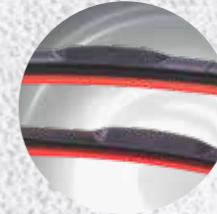

YN-PS2416F | ENCAIXE **F**

MODELO	ANO
IMPREZA	2008/2016

MOT. 24" PAX. 16"



PEUGEOT



YN-PR1199 | ENCAIXE **F**

MODELO	ANO
206	1998:2009
206 CC	2001:2008
206 SW	2005:2008
207	2008:2015

MOT. 26" PAX. 16"

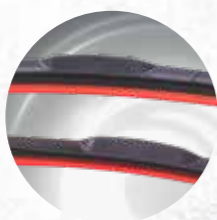

YN-PS2826B | ENCAIXE **B**

MODELO	ANO
308	2012/2019
308 CC SW	2012/2019
408	2012/2019
508	2012/2019

MOT. 24" PAX. 17"



YN-PS1525 | ENCAIXE **C**

MODELO	ANO
407/407 SW	2004/2009

MOT. 28" PAX. 28"



YN-PS2615A | ENCAIXE **A**

MODELO	ANO
208	2014/2019
208	2012/2018

MOT. 26" PAX. 15"



YN-PS2826A | ENCAIXE **A**

MODELO	ANO
307 / 307 SW	2006/2012
307 SEDAN/307 CC	2006/2011

MOT. 24" PAX. 17"



TOYOTA



YN-PS0026T | ENCAIXE **T**

MODELO	ANO
ETIOS	2012/2024

MOT. 26" PAX. 26"

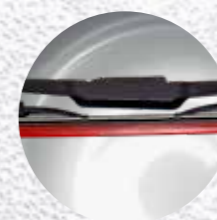

YN-PS1816F | ENCAIXE **F**

MODELO	ANO
JIMNY	****

MOT. 18" PAX. 16"



YN-PS2216F | ENCAIXE **F**

MODELO	ANO
HILUX	2016:

MOT. 22" PAX. 16"



YN-PS2416F | ENCAIXE **F**

MODELO	ANO
RAV4	2000:2012

MOT. 24" PAX. 16"



YN-PS2614F | ENCAIXE **F**

MODELO	ANO
COROLLA	2015/2019
RAV 4	2015:
COROLLA CROSS	2009:2015

MOT. 26" PAX. 16"



FIAT

FIAT

YN-PS1395 | ENCAIXE **A**

MODELO	ANO
IDEA/IDEA ADVENTURE	2014/2017

MOT. 28" PAX. 26"



YN-PS2017F | ENCAIXE **F**

MODELO	ANO
IDEA IDEA ADVENTURE	2014/2017 2014/2017

MOT. 26" PAX. 26"

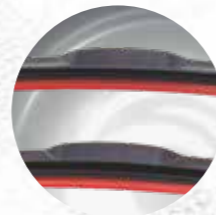

YN-PS2216F | ENCAIXE **F**

MODELO	ANO
MOBI UNO	2016/2018 2011/2014

MOT. 18" PAX. 16"



YN-PS2415D | ENCAIXE **D**

MODELO	ANO
IDEA ADVENTURE IDEA	2010/2014 2010/2014

MOT. 24" PAX. 15"

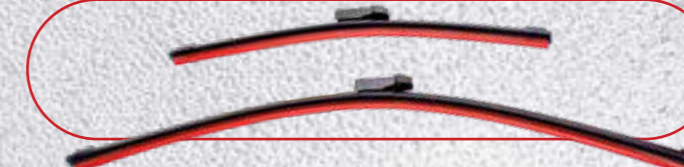
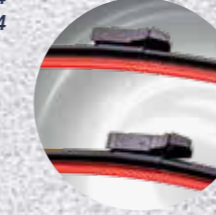

YN-PS2416A | ENCAIXE **A**

MODELO	ANO
NOVO UNO ARGO CRONOS PULSE STRADA NOVA	2015/2024 2017/2024 2018/2024 2021/2024 2015/2018

MOT. 24" PAX. 24"



FIAT

FIAT

YN-PS2416B | ENCAIXE **B**

MODELO	ANO
PALIO GRAN SIENA BRAVO	2012 2012 2011

MOT. 24" PAX. 16"



YN-PS2416F | ENCAIXE **F**

MODELO	ANO
IDEA /IDEA ADVENTURE	2006/2010

MOT. 24" PAX. 16"



YN-PS2418B | ENCAIXE **B**

MODELO	ANO
FREEMONT BRAVO	2011/2015 2011/2024

MOT. 24" PAX. 17"



YN-PS2615A | ENCAIXE **A**

MODELO	ANO
LINEA PUNTO	2008/2017 2008/2017

MOT. 26" PAX. 15"

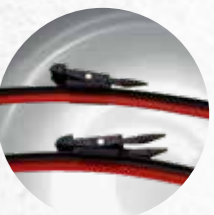

AUDI



YN-PS1396 | ENCAIXE **A**

MODELO	ANO
A3/A3 SPORTBACK	2007/2012

MOT. 24" PAX. 19"

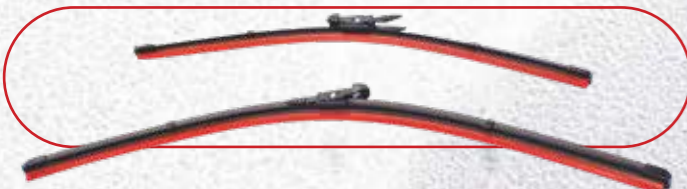

YN-PS1402 | ENCAIXE **B**

MODELO	ANO
TT	2014/2018

MOT. 24" PAX. 21"



YN-PS1529 | ENCAIXE **E**

MODELO	ANO
A1	2012/2024

MOT. 24" PAX. 15"

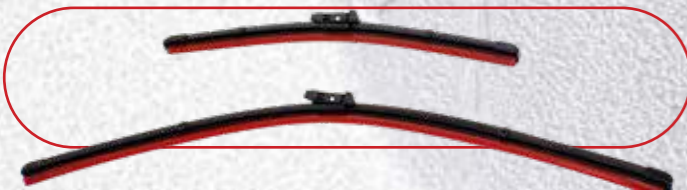

YN-PS2222V | ENCAIXE **V**

MODELO	ANO
A4	2003/2007
A4 AVANT	2003/2008
A6	2001/2005

MOT. 22" PAX. 22"



YN-PS2420E | ENCAIXE **E**

MODELO	ANO
A4L	2009:
A5	2009:
Q5	2009:
TT	2014/2018
Q3	2013:

MOT. 24" PAX. 21"



YN-PS2618F | ENCAIXE **F**

MODELO	ANO
A3 CABRIO	2012/2024
A3	2012/2024
A3 SPORTBACK	2012/2024

MOT. 26" PAX. 18"

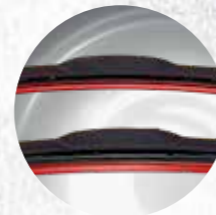

AUDI



YN-PS2620E | ENCAIXE **E**

MODELO	ANO
A6 AVANT	2011:
Q7	2015:
A7	2010/2017

MOT. 26" PAX. 20"



BMW



YN-PS1396 | ENCAIXE **A**

MODELO	ANO
SÉRIE 3 - 318I, 320I, 325I, 328I	2010/2015
X1	2010/2015

MOT. 24" PAX. 19"



YN-PS2420F | ENCAIXE **F**

MODELO	ANO
X5 3.0/4.0	2016/2024
X6 3.0/4.0	2016/2024

MOT. 24" PAX. 20"



BMW



YN-PS2615B | ENCAIXE **B**

MODELO	ANO
X1	2010/2019

MOT. 25" PAX. 16"



MERCEDES BENZ



YN-PS1396 | ENCAIXE **A**

MODELO	ANO
CLASSE GLA 200	2015/2024

MOT. 24" PAX. 19"



YN-PS1399 | ENCAIXE **A**

MODELO	ANO
CLASSE SLK	2005/2011

MOT. 24" PAX. 21"



MERCEDES BENZ



YN-PS1396 | ENCAIXE **A**

MODELO	ANO
CLASSE GLA 200	2015/2024

MOT. 24" PAX. 19"



YN-PS1526 | ENCAIXE **C**

MODELO	ANO
CLASSE C	2009/2014

MOT. 24" PAX. 26"



YN-PS1527 | ENCAIXE **C**

MODELO	ANO
CLASSE CLS	2005/2011
CLASSE E	2002/2008
CLASSE SL	2001/2012

MOT. 26" PAX. 26"



YN-PS1528 | ENCAIXE **C**

MODELO	ANO
CLASSE E	2005/2011

MOT. 26" PAX. 26"



YN-PS2119C | ENCAIXE **C**

MODELO	ANO
CLASS GLK	2009/2015

MOT. 21" PAX. 19"



YN-PS2419Z | ENCAIXE **Z**

MODELO	ANO
GLA	2015/2024

MOT. 24" PAX. 18"

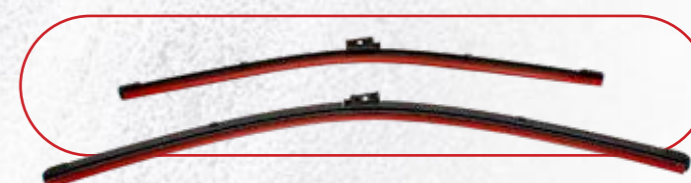

MERCEDES BENZ



YN-PS2424B | ENCAIXE **B**

MODELO	ANO
C180	2012/2015

MOT. 24" PAX. 24"



VOLKSWAGEN



YN-PS1333 | ENCAIXE **E**

MODELO	ANO
UP	2014*

MOT. 24" PAX. 16"



YN-PS1530 | ENCAIXE **E**

MODELO	ANO
FUSCA	2012/2024

MOT. 22" PAX. 22"

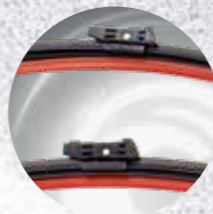

VOLKSWAGEN



YN-PS2119B | ENCAIXE **B**

MODELO	ANO
POLO GTI 09-14	2009/2014
POLO GTI BLUE. 09-14	2009/2014
POLO SEDAN 10-14	2010/2014

MOT. 21" PAX. 19"

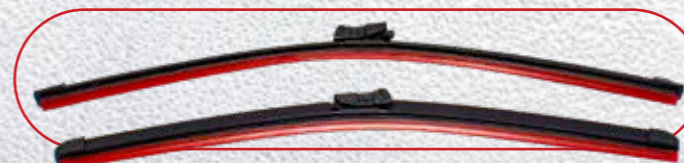

YN-PS2119C | ENCAIXE **C**

MODELO	ANO
GOLF IV	2008/2014

MOT. 21" PAX. 19"



YN-PS2216E | ENCAIXE **E**

MODELO	ANO
GOL GVI	2013/2016
VOYAGE	2013/2024
SAVEIRO	2013

MOT. 22" PAX. 16"



YN-PS2216F | ENCAIXE **F**

MODELO	ANO
GOL G5	2008/2012
GOL G7	2016/2018
VOYAGE G3	2008/2012

MOT. 22" PAX. 16"



YN-PS2418E | ENCAIXE **E**

MODELO	ANO
T-CROSS	2019/2024

MOT. 25" PAX. 18"



YN-PS2419B | ENCAIXE **B**

MODELO	ANO
JETTA	2007/2010
JETTA VARIANT	2008/2014
PASSAT VI	2005/2011
PASSAT CC	2008/2011
PASSAT VARIANT	2005/2011

MOT. 24" PAX. 18"



VOLKSWAGEN



YN-PS2419E | ENCAIXE **E**

MODELO	ANO
JETTA	2011/2018
PASSAT VII	2012/2014
PASSAT CC	2012/2017
PASSAT VARIANT	2006/2014

MOT. 24" PAX. 19"



YN-PS2420E | ENCAIXE **E**

MODELO	ANO
TIGUAN	2017>

MOT. 24" PAX. 21"



YN-PS2424E | ENCAIXE **E**

MODELO	ANO
AMAROK	2013/2024
DELIVERY 9.170	2018/2024

MOT. 24" PAX. 24"



YN-PS2618E | ENCAIXE **E**

MODELO	ANO
GOLF VII	2014/2024
GOLF VII VARIANT	2014/2024
JETTA	2018/2024
NIVUS	2021/2024
POLO	2018/2024
TAOS	2022/2024
VITRUS	2018/2024

MOT. 26" PAX. 18"



VOLVO



YN-PS1400 | ENCAIXE **A**

MODELO	ANO
S60	2004/2010
V70	2004/2007
XC70/XC90	2005/2007

MOT. 21" PAX. 19"



YN-PS2419B | ENCAIXE **B**

MODELO	ANO
V40	2013>

MOT. 24" PAX. 18"



YN-PS2419E | ENCAIXE **E**

MODELO	ANO
XC40	2018/2024
XC90	2016/2024

MOT. 24" PAX. 19"

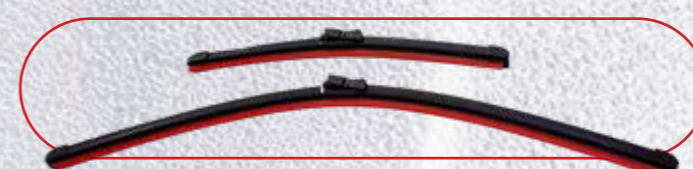

YN-PS2620B | ENCAIXE **B**

MODELO	ANO
XC60	2008/2010
S80	2006/2016
S60	2010/2018
S40	2007/2013
V70	2008/2016
V60	2010/2017
V50	2006/2013
C30	2006/2013
XC70	2007/2016

MOT. 26" PAX. 20"



OPEL



YN-PS2218C | ENCAIXE **G**

MODELO	ANO
VECTRA	2008/2012
VECTRA GT	2007
VECTRA GTX	2007

MOT. 22" PAX. 18"



YN-PS2615A | ENCAIXE **A**

MODELO	ANO
OMEGA	2008/2013

MOT. 26" PAX. 15"



MITSUBISHI MOTORS



YN-PS1918F | ENCAIXE **F**

MODELO	ANO
PAJERO TR4	****
GRAND VITARA	****
L200 OUTDOOR	****

MOT. 19" PAX. 18"



YN-PS2218F | ENCAIXE **F**

MODELO	ANO
PAJERO DAKAR	****
TRITON/ALL	****
PAJERO FULL	****

MOT. 22" PAX. 18"



MITSUBISHI MOTORS



YN-PS1918F | ENCAIXE **F**

MODELO	ANO
PAJERO TR4	****
GRAND VITARA	****
L200 OUTDOOR	****

MOT. 19" PAX. 18"



YN-PS2218F | ENCAIXE **F**

MODELO	ANO
PAJERO DAKAR	****
TRITON/ALL	****
PAJERO FULL	****

MOT. 22" PAX. 18"



YN-PS2416F | ENCAIXE **F**

MODELO	ANO
OUTLANDER RE/	****

MOT. 24" PAX. 16"

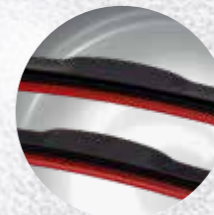

YN-PS2421F | ENCAIXE **F**

MODELO	ANO
ASX	****
OUTLANDER	****
LANCER	****

MOT. 24" PAX. 21"



CHERY



YN-PS2216F | ENCAIXE **F**

MODELO	ANO
FACE	2010/2015
QQ	2011/2015
S18	2010/2012

MOT. 22" PAX. 16"



YN-PS2416B | ENCAIXE **B**

MODELO	ANO
ARRIZO 5	2010/2024

MOT. 24" PAX. 16"



MAZDA



YN-PS2416F | ENCAIXE **F**

MODELO	ANO
PREMACY	1999/2004

MOT. 24" PAX. 16"



LAND ROVER



YN-PS2321B | ENCAIXE **B**

MODELO	ANO
RANGE ROVER	2011/2024

MOT. 23" PAX. 21"



LIFAN



YN-PS2416F | ENCAIXE **F**

MODELO	ANO
620	2010/2012

MOT. 24" PAX. 16"



SUZUKI



YN-PS2416F | ENCAIXE **F**

MODELO	ANO
VITARA	2017
S-CROSS	2017

MOT. 22" PAX. 16"



JAC MOTORS



YN-PS2216F | ENCAIXE **F**

MODELO	ANO
J3	2010-2015

MOT. 24" PAX. 21"

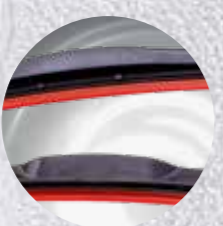

PONTIAC



YN-PS2421F | ENCAIXE **F**

MODELO	ANO
CAMARO	2008/2018

MOT. 24" PAX. 21"



ALFA ROMEO



YN-PS2216F | ENCAIXE **F**

MODELO	ANO
147	2001/2005

MOT. 21" PAX. 19"

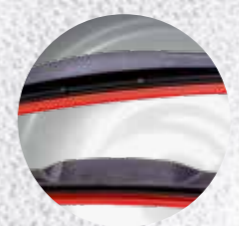

TROLLER



YN-PS1616D | ENCAIXE **D**
MODELO ANO
JIMNY 2015/2024

MOT. 16" PAX. 16"

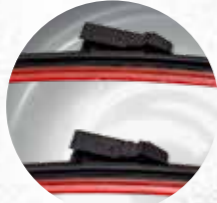

Com melhor aerodinâmica e aderência, nosso produto oferece não apenas um desempenho excepcional, mas também uma ótima visibilidade, garantindo uma jornada mais segura e confiante.





10" - 14"

PALHETAS TRASEIRAS ESPECÍFICAS



Design simplificado produzida em material de qualidade excelente!



MITSUBISHI MOTORS



YON-PR1201	CONEXÃO B	TRAS 13"
MODELO	ANO	
ASX	2012/2024	



YON-PR1202	CONEXÃO B	TRAS 12"
MODELO	ANO	
EC7	2014	
1161A	2012/2024	
1181	2008/2024	
1201	2006/2024	
123	2008/2024	
125I	2013/2024	
X5	2016/2024	
OUTLANDER	2007/2024	



YON-PR1204	CONEXÃO B	TRAS 16"
MODELO	ANO	
PAJERO TR4	****	



YON-PR1218	CONEXÃO B	TRAS 10"
MODELO	ANO	
PAJERO SPORT	2008/2011	



YON-PR1232	CONEXÃO B	TRAS 12"
MODELO	ANO	
PAJERO CLASSIC	1991/2000	
PAJERO	1991/2000	



YON-PR1236	CONEXÃO B	TRAS 16"
MODELO	ANO	
PAJERO	1990/2003	
PAJERO FULL	2002/2007	
PAJERO SPORT	1998/2007	
TR4	2001/2009	



MITSUBISHI MOTORS



YN-PSTR01 | CONEXÃO B

MODELO	ANO
OUTLANDER ASX	2007/2024 2012/2024

TRAS 14"



PEUGEOT



YN-PR1201 | CONEXÃO B

MODELO	ANO
4008	2012

TRAS 13"



YN-PR1205 | CONEXÃO B

MODELO	ANO
108	2014

TRAS 12"



PEUGEOT



YN-PR1206 | CONEXÃO B

MODELO	ANO
206 207 208 307	1998/2009 2001/2024 2012/2024 2001/2024

TRAS 12"



YN-PR1208 | CONEXÃO B

MODELO	ANO
207 SW 3008 308 508 SW 308 SW	2009/2013 2010/2024 2012/2024 2008 2008

TRAS 14"



YN-PR1210 | CONEXÃO B

MODELO	ANO
206SW 406ESTATE	2002 1996/2004

TRAS 14"



YN-PR1211 | CONEXÃO B

MODELO	ANO
C4 IH/B	2010/2016

TRAS 14"

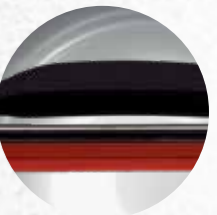

YN-PR1223 | CONEXÃO B

MODELO	ANO
CLIO4	2012

TRAS 12"



YN-PR1225 | CONEXÃO B

MODELO	ANO
207 SW 3008 308	2009/2013 2010/2024 2012/2024

TRAS 11"



HONDA



YN-PR1201 | CONEXÃO **B**

MODELO	ANO
VEZEL	2014
XR-V	2014
HR-V	2015/2024
CRV	2018/2024

TRAS 13"



YN-PR1203 | CONEXÃO **B**

MODELO	ANO
CR-V	2008/2012
WR-V	2017
FIT	2003/2008
FIT NEW	2009/2014
FIT NEW	2015
MR-V	2003/2008
FREED	2008

TRAS 14"

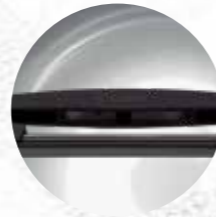

YN-PR1206 | CONEXÃO **B**

MODELO	ANO
FIT	2003/2008
FIT NEW	2009/2014

TRAS 12"



YN-PR1207 | CONEXÃO **B**

MODELO	ANO
CITY	2009/2014

TRAS 28"

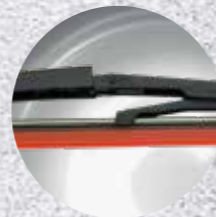

YN-PR1208 | CONEXÃO **B**

MODELO	ANO
CIVIC	****

TRAS 14"



YN-PR1212 | CONEXÃO **B**

MODELO	ANO
HRV XL	2018/2024

TRAS 10"

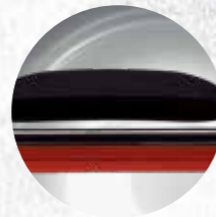

HONDA



YN-PR1217 | CONEXÃO **B**

MODELO	ANO
NEW CRV	2014/2017

TRAS 10"

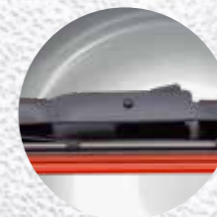

YN-PR1231 | CONEXÃO **B**

MODELO	ANO
AIRWAVE	2005

TRAS 14"

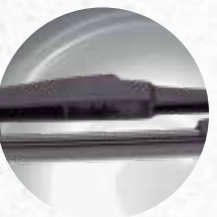

YN-PR1232 | CONEXÃO **B**

MODELO	ANO
HR-V	2015/2024
CITY	2009/2014

TRAS 12"



YN-PR1237 | CONEXÃO **B**

MODELO	ANO
CRV	1995/2001

TRAS 26"

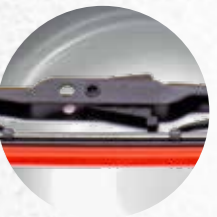

YN-PSTR01 | CONEXÃO **B**

MODELO	ANO
CRV	2017/2024
HR-V EX	2007/2012

TRAS 24"



JAC MOTORS



YN-PR1201 | CONEXÃO **B**

MODELO	ANO
T40	2018/2024
T5	2016/2019

TRAS 13"



YN-PR1203 | CONEXÃO **B**

MODELO	ANO
J3	2010
J8	2015

TRAS 28"



YN-PR1232 | CONEXÃO **B**

MODELO	ANO
J6	2010/2024

TRAS 26"



YN-PSTR01 | CONEXÃO **B**

MODELO	ANO
T40	2018/2024
T5	2016/2019

TRAS 14"



SUZUKI



YN-PR1201 | CONEXÃO **B**

MODELO	ANO
SX4	2009/2015

TRAS 26"



YN-PR1205 | CONEXÃO **B**

MODELO	ANO
GRAND VITARA	2010/2024

TRAS 28"



YN-PR1232 | CONEXÃO **B**

MODELO	ANO
GRAND VITARA	1998/2007
SWIFT HATCH	1993/1999
VITARA	1990/1998

TRAS 12"



YN-PR1238 | CONEXÃO **B**

MODELO	ANO
XSARA PICASSO	1999
XSARA	1997/2005

TRAS 24"



YN-PSTR01 | CONEXÃO **B**

MODELO	ANO
SX4	2009/2015

TRAS 21"



CHERY



YN-PR1202 | CONEXÃO B

FACE	MODELO	ANO
QQ		2011-2013

TRAS 26"



YN-PR1205 | CONEXÃO B

FACE	MODELO	ANO
TIGGO3		2007

TRAS 28"



YN-PSTR01 | CONEXÃO B

FACE	MODELO	ANO
QQ		2010/2015 2016/2024

TRAS 26"



YN-PR1232 | CONEXÃO B

FACE	MODELO	ANO
QQ		2016/2024

TRAS 26"



YN-PR1233 | CONEXÃO B

FACE	MODELO	ANO
CELER TIGGO		2013-2009/2015

TRAS 13"



YN-PR1234 | CONEXÃO B

FACE	MODELO	ANO
CELER QQ		2013/2024 2011/2015

TRAS 26"



YN-PR1237 | CONEXÃO B

FACE	MODELO	ANO
CELER QQ		2013/2024 2011/2015

TRAS 24"



LIFAN



YN-PR1202 | CONEXÃO B

FACE	MODELO	ANO
320		2010/2012

TRAS 21"



YN-PSTR01 | CONEXÃO B

FACE	MODELO	ANO
320		2010/2012

TRAS 22"



NISSAN



YN-PR1202 | CONEXÃO **B**

MODELO	ANO
MARCH	2015/2024
MURANO	2007/2011
PATHFINDER	2005/2010

TRAS 26"

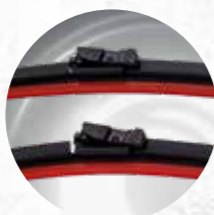

YN-PR1206 | CONEXÃO **B**

MODELO	ANO
TIIDA	2008/2013

TRAS 28"



YN-PR1225 | CONEXÃO **B**

MODELO	ANO
GRAND LIVINA	2009/2024
KICKS	2016/2024
LIVINA	2009/2024

TRAS 26"



YN-PR1232 | CONEXÃO **B**

MODELO	ANO
XTRAIL	2013/2016

TRAS 24"



YN-PR1233 | CONEXÃO **B**

MODELO	ANO
XTERRA	2006

TRAS 26"



YN-PSTR01 | CONEXÃO **B**

MODELO	ANO
MARCH	2015/2024
MURANO	2007/2011
PATHFINDER	2005/2010

TRAS 14"



SUBARU



YN-PR1203 | CONEXÃO **B**

MODELO	ANO
FORESTER	2015

TRAS 26"



YN-PR1234 | CONEXÃO **B**

MODELO	ANO
VIVIO	1993/1997

TRAS 28"



YN-PR1237 | CONEXÃO **B**

MODELO	ANO
VIVIO	1993/1997

TRAS 26"



TOYOTA



YN-PR1203 | CONEXÃO **B**

MODELO	ANO
COROLLA	2001/2007

TRAS 14"



YN-PR1205 | CONEXÃO **B**

MODELO	ANO
HILUX SW4	2005/2024
RAV4	2005/2013
YARIS	2006/2016
ETIO SEDAN	****
PRADO	2010/2015
AVENSIS 3 ST	2003/2009
AVENSIS	2010
INNOVA	2007
FORTUNER	2008
VERSO/VERSO-S	****
WISH	2004
EZ	2011
LIVA	2011

TRAS 16"



YN-PR1224 | CONEXÃO **B**

MODELO	ANO
AYGO	2005/2015

TRAS 12"



YN-PR1231 | CONEXÃO **B**

MODELO	ANO
FIELDER	2005
AVANZA	2008

TRAS 14"

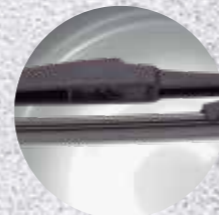

YN-PR1234 | CONEXÃO **B**

MODELO	ANO
CAMRY WAGON	1992/1993

TRAS 14"



YN-PR1237 | CONEXÃO **B**

MODELO	ANO
CAMRY WAGON	1992/1993

TRAS 14"



KIA



YN-PR1203 | CONEXÃO **B**

MODELO	ANO
SORENTO	2010/2012
RIO	2008/2014
ACCENT	2006/2011
RONDO	2008/2012

TRAS 26"



YN-PR1205 | CONEXÃO **B**

MODELO	ANO
SORENTO	2017

TRAS 12"



YN-PR1226 | CONEXÃO **B**

MODELO	ANO
PICANTO	2012/2024
SPORTAGE R	2011/2016
PICANTO NEW	2012/2024

TRAS 26"

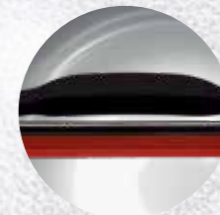

YN-PR1231 | CONEXÃO **B**

MODELO	ANO
MOHAVE	2009

TRAS 24"



YN-PR1233 | CONEXÃO **B**

MODELO	ANO
SORENTO	2003/2009

TRAS 21"



FIAT

FIAT

YN-PR1205 | CONEXÃO **B**

MODELO	ANO
FREEMONT	2011/2015
500	2012/2015

TRAS 14"



YN-PR1208 | CONEXÃO **B**

MODELO	ANO
PUNTO	2008/2024
BRAVO	2012/2024

TRAS 14"



YN-PR1212 | CONEXÃO **B**

MODELO	ANO
UNO	2010
MOBI	2016
TIPO	2016

TRAS 26"

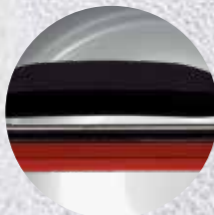

YN-PR1218 | CONEXÃO **B**

MODELO	ANO
PALIO	1996/2016

TRAS 10"



YN-PR1219 | CONEXÃO **B**

MODELO	ANO
ARGO	2018/2024
PULSE	2018/2024

TRAS 10"



YN-PR1225 | CONEXÃO **B**

MODELO	ANO
500 HATCHBACK	2007
500L	2014
500X	2014
BRAVO	2012/2024
PUNTO	2008/2024

TRAS 11"



FIAT

FIAT

YN-PR1232 | CONEXÃO **B**

MODELO	ANO
147	1977/1987
OGI	1983/1985
PANORAMA	1982/1986
PREMIO DUNA	1985/1996
PREMIO	1985/1996
SPAZIO	1977/1987
FIORINO	1982/1986
FIORINO PICKUP	1982/1986

TRAS 12"



YN-PR1234 | CONEXÃO **B**

MODELO	ANO
ELBA	1986/1994
UNO	1984/1994

TRAS 14"



YN-PR1235 | CONEXÃO **B**

MODELO	ANO
TIPO	1993/1997

TRAS 15"



YN-PR1237 | CONEXÃO **B**

MODELO	ANO
ELBA	1986/1994
UNO	1984/1994

TRAS 18"



DODGE



YN-PR1205 | CONEXÃO B

MODELO	ANO
JOURNEY	2011

TRAS 16"



LAND ROVER



YN-PR1205 | CONEXÃO B

MODELO	ANO
DISCOVERY	2013/2018

TRAS 26"



YN-PR1234 | CONEXÃO B

MODELO	ANO
FREELANDER	1998/2006

TRAS 28"



LAND ROVER



YN-PR1237 | CONEXÃO B

MODELO	ANO
FREELANDER	1998/2006

TRAS 18"



SSANGYONG



YN-PR1205 | CONEXÃO B

MODELO	ANO
KYRON	2009

TRAS 16"



YN-PR1231 | CONEXÃO B

MODELO	ANO
KORANDO	2011

TRAS 14"



HYUNDAI



YN-PR1208 | CONEXÃO **B**

MODELO	ANO
HB20	2012/2024

TRAS 14"



YN-PR1225 | CONEXÃO **B**

MODELO	ANO
HB20	2012/2024

TRAS 11"



YN-PR1226 | CONEXÃO **B**

MODELO	ANO
I30	2010/2024
IX35	2010/2024
I10	****
HB20	2013
TUCSON	2010/2015

TRAS 12"

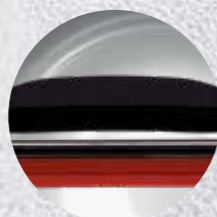

YN-PR1231 | CONEXÃO **B**

MODELO	ANO
SANTA FÉ	2008/2013
VERA CRUZ	2008
TUCSON	2017/2024

TRAS 14"



YN-PR1232 | CONEXÃO **B**

MODELO	ANO
ELANTRA	2011/2015

TRAS 12"



YN-PR1234 | CONEXÃO **B**

MODELO	ANO
SANTA FÉ	2001/2006

TRAS 14"



HYUNDAI



YN-PR1237 | CONEXÃO **B**

MODELO	ANO
SANTA FÉ	2001/2006

TRAS 18"



YN-PR1240 | CONEXÃO **B**

MODELO	ANO
TUCSON	2017/2024
SANTA FÉ	2007/2012

TRAS 14"



OPEL



YN-PR1205 | CONEXÃO **B**

MODELO	ANO
ASTRA	2007

TRAS 16"



YN-PR1210 | CONEXÃO **B**

MODELO	ANO
ADAM	2013

TRAS 14"



OPEL



YN-PR1220 | CONEXÃO B

MODELO	ANO
HR-V	2018>

TRAS 11"



FORD



YN-PR1205 | CONEXÃO B

MODELO	ANO
IMAX	2009

TRAS 16"



YN-PR1206 | CONEXÃO B

MODELO	ANO
EDGE	2008/2014

TRAS 12"



FORD



YN-PR1208 | CONEXÃO B

MODELO	ANO
C-MAX	2004

TRAS 14"



YN-PR1210 | CONEXÃO B

MODELO	ANO
EDGE	2010/2016
FOCUS	2008/2013
FOCUS HATCH	2008/2013

TRAS 14"



YN-PR1218 | CONEXÃO B

MODELO	ANO
KA	2002/2013

TRAS 10"



YN-PR1219 | CONEXÃO B

MODELO	ANO
ECOSPORT	2017
KA	2014>
KUGA	2013
EXPLORER	2011

TRAS 10"



YN-PR1224 | CONEXÃO B

MODELO	ANO
FIESTA	2002/2009
FIESTA HATCH	2006/2014
ESCAPE	2008/2012
FLEX	2009/2013
ECOSPORT	2003/2012

TRAS 12"



YN-PR1225 | CONEXÃO B

MODELO	ANO
KA MK2 HATCHBACK	2008/2014

TRAS 11"



FORD



YN-PR1232 | CONEXÃO **B**

MODELO	ANO
FOCUS	2000/2007

 TRAS 12"



YN-PR1233 | CONEXÃO **B**

MODELO	ANO
ESCORT ZETEC EXPLORER	1997/ 1991/2000

 TRAS 13"



YN-PR1234 | CONEXÃO **B**

MODELO	ANO
MONDEO SW	1993/2000

 TRAS 14"



YN-PR1236 | CONEXÃO **B**

MODELO	ANO
FIESTA MK3	1989/1996

 TRAS 18"



YN-PR1237 | CONEXÃO **B**

MODELO	ANO
MONDEO SW	1993/2000

 TRAS 18"



JEEP



YN-PR1205 | CONEXÃO **B**

MODELO	ANO
CHEROKEE GRAND MK4	2011/2015

 TRAS 12"



YN-PR1212 | CONEXÃO **B**

MODELO	ANO
RENEGADE	2014

 TRAS 10"



YN-PR1232 | CONEXÃO **B**

MODELO	ANO
WRANGLER	2007/2024

 TRAS 12"



YN-PR1233 | CONEXÃO **B**

MODELO	ANO
CHEROKEE GRAND CHEROKEE	1993/1998 1992/1999

 TRAS 13"



YN-PR1234 | CONEXÃO **B**

MODELO	ANO
CHEROKEE WRANGLER	1997/2001 1996/2006

 TRAS 14"



YN-PR1237 | CONEXÃO **B**

MODELO	ANO
CHEROKEE WRANGLER	1997/2001 1996/2006

 TRAS 18"



MERCEDES BENZ



YN-PR1208 | CONEXÃO **B**

MODELO	ANO
ML	****
CLASSE B B150, B170, B180, B200	2006/2024

TRAS. 14"



YN-PR1225 | CONEXÃO **B**

MODELO	ANO
CLASSE B	2008

TRAS. 11"



YN-PR1232 | CONEXÃO **B**

MODELO	ANO
CLASSE G	1998/2005
CLASSE M	1998/2005

TRAS. 12"



YN-PR1236 | CONEXÃO **B**

MODELO	ANO
CLASSE G	2015

TRAS. 16"



YN-PR1241 | CONEXÃO **B**

MODELO	ANO
VITO	2005/2011

TRAS. 14"



CITROËN



YN-PR1206 | CONEXÃO **B**

MODELO	ANO
C3	2002/2008

TRAS. 12"



YN-PR1208 | CONEXÃO **B**

MODELO	ANO
AIRCROSS	2008/2024
C3 NOVO	2009/2024
C3 PICASSO	2012/2015
C4 HATCH	2007/2014
C5	2012/2024
C5 BREAK	2009/2024
DS3	2012/2014

TRAS. 14"



YN-PR1224 | CONEXÃO **B**

MODELO	ANO
C1	2005/2015

TRAS. 12"

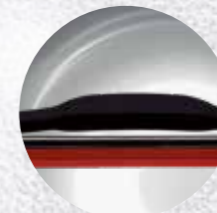

YN-PR1225 | CONEXÃO **B**

MODELO	ANO
AIRCROSS	2008/2024
C3	2009/2024
C3 PICASSO	2012/2015
C4 HATCH	2007/2014
C5	2012/2024
C5 BREAK	2009/2024
DS3	2012/2014

TRAS. 11"



YN-PR1236 | CONEXÃO **B**

MODELO	ANO
BERLINGO	1996/2000

TRAS. 16"



RENAULT



YN-PR1208 | CONEXÃO **B**

MODELO	ANO
DUSTER	2012/2019
SANDERO	2014/2024
CAPTUR	2017/2024
CLIO 2	2006/2016
MODUS	2004
TWINGO 2	2007
AVANTIME	2001

TRAS 26"



YN-PR1210 | CONEXÃO **B**

MODELO	ANO
KANGOO	1997
MEGANE 3 COUPE	2008
LAGUNA GRAND	2005

TRAS 28"



YN-PR1224 | CONEXÃO **B**

MODELO	ANO
TWINGO	1993/2007

TRAS 26"

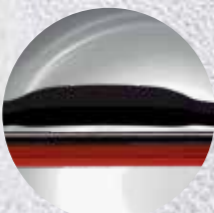

YN-PR1225 | CONEXÃO **B**

MODELO	ANO
CLIO 3 ESTATE	2005
KWID	2018
MEGANE GRAND TOUR	2007
SCENIC GRAND	2008
SCENIC II	2003/2009
SANDERO	2014/2024
CAPTUR	2017/2024

TRAS 11"



VOLVO



YN-PR1209 | CONEXÃO **B**

MODELO	ANO
V60	2016

TRAS 12"



YN-PR1220 | CONEXÃO **B**

MODELO	ANO
XC90	2007/2008
XC60	2009/2011

TRAS 11"



YN-PRv | CONEXÃO **B**

MODELO	ANO
XC90	2015
XC70	2008
V70	2008

TRAS 11"



VOLKSWAGEN



YN-PR1213 | CONEXÃO **B**

MODELO	ANO
GOLF 6	2015
POLO	2009
GOLF 7	2017

TRAS. 11"



YN-PR1214 | CONEXÃO **B**

MODELO	ANO
TOURAN	2012
SHARAN	2012
LAVIDA	****

TRAS. 14"



YN-PR1215 | CONEXÃO **B**

MODELO	ANO
SCIROCCO R	2010
UP	2011

TRAS. 10"

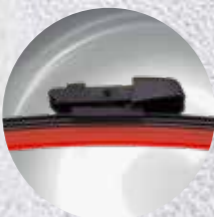

YN-PR1218 | CONEXÃO **B**

MODELO	ANO
PARATI G3	1999/2002
POLO	1999/2007
POLO HATCH	1999/2002

TRAS. 24"



YN-PR1227 | CONEXÃO **B**

MODELO	ANO
JETTA VARIANT	2011
T5	2006
CADDY	2007
TOURAN	2003/2011

TRAS. 16"



YN-PR1229 | CONEXÃO **B**

MODELO	ANO
PASSAT VARIANT	2009

TRAS. 11"



VOLKSWAGEN



YN-PR1230 | CONEXÃO **B**

MODELO	ANO
T5 2D L&R	****

TRAS. 18"



YN-PR1234 | CONEXÃO **B**

MODELO	ANO
GOLF G3	1993/1998
GOLF G4	1999/2006
POLO HATCH	2002/2008
VARIANT G2	1977/1983

TRAS. 14"



BMW



YN-PR1210 | CONEXÃO **B**

MODELO	ANO
X3	2003/2010

TRAS 14"



YN-PR1212 | CONEXÃO **B**

MODELO	ANO
COOPER S/D	2013
COOPER ONE/D	2014

TRAS 28"

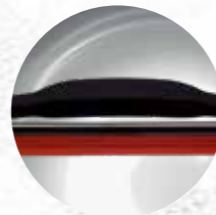

YN-PR1220 | CONEXÃO **B**

MODELO	ANO
X5	2007/2013

TRAS 26"

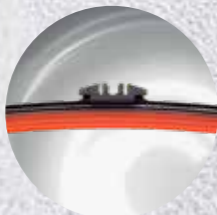

YN-PR1221 | CONEXÃO **B**

MODELO	ANO
5 SERIES F11	2013

TRAS 11"



YN-PR1232 | CONEXÃO **B**

MODELO	ANO
3 SRIES E46	1998/2005

TRAS 24"



YN-PR1235 | CONEXÃO **B**

MODELO	ANO
E61	2003/2010

TRAS 15"



BMW



YN-PR1236 | CONEXÃO **B**

MODELO	ANO
CITY	2009/2014

TRAS 28"



YN-PR1238 | CONEXÃO **B**

MODELO	ANO
VECTRA C	2002/2005
CORSA C	2001/2011
MERIVA B	2010
MERIVA A	2003/2010
ASTRA G HATCH	1998/2005
ZAFIRA A	2002/2005

TRAS 16"



YN-PSTR01 | CONEXÃO **B**

MODELO	ANO
116IA	2012/2024
118I	2008/2024
120I	2006/2024
123	2008/2024
125I	2013/2024
X5	2016/2024

TRAS 14"



JOHN DEERE



YN-PR1232 | CONEXÃO **B**

MODELO	ANO
RETROSCAVADEIRA 310L YUAN PLUS	1950/2024

TRAS 12"



DAIHATSU



YN-PR1232 | **B**

MODELO	ANO
CUORE	1999/2001

TRAS 12"

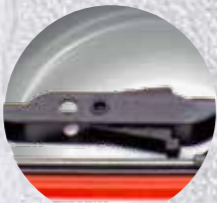

AGRALE



YN-PR1232 | CONEXÃO **B**

MODELO	ANO
TRATOR 575	1950/2024

TRAS 12"



CASE CONSTRUCTION



YN-PR1232 | **B**

MODELO	ANO
RETROESC. 580M / 580N	1950/2024

TRAS 26"



JPX - JAPAN EXCHANGE GROUP



YN-PR1232 | CONEXÃO B

MODELO	ANO
MONTEZ	1994/2002

TRAS 12"



GURGEL



YN-PR1232 | CONEXÃO B

MODELO	ANO
BR800	1989/1991
CARAJÁS X15	1986/1991
SUPERMINI	1992/1995
X12	1981/1991

TRAS 12"



LADA



YN-PR1234 | CONEXÃO B

MODELO	ANO
LAIKA	1990/1995
NIVA	1990/1995

TRAS 14"



YN-PR1237 | CONEXÃO B

MODELO	ANO
LAIKA	1990/1995
NIVA	1990/1995

TRAS 18"



SEAT



YN-PR1234 | CONEXÃO B

MODELO	ANO
IBIZA	1994/1999

TRAS 14"



SCANIA



YN-PR1234 | CONEXÃO **B**

MODELO	ANO
111	1976/1981

TRAS 14"



CHRYSLER



YN-PR1236 | **B**

MODELO	ANO
PT CRUISER	2000>
TOWN & COUNTRY	2008>

TRAS 16"



ASIA MOTORS



YN-PR1234 | CONEXÃO **B**

MODELO	ANO
TOWNER	1993/1999

TRAS 16"



CATERPILLAR



YN-PR1232 | CONEXÃO **B**

MODELO	ANO
MINI CARREGADEIRA	1950/2024
PÁ CARREGADEIRA	1950/2024

TRAS 12"



YN-PR1234 | CONEXÃO **B**

MODELO	ANO
MOTONIV. 120K, 12K, 140K	1950/2024

TRAS 16"



AUDI



YN-PR1233 | CONEXÃO **B**

MODELO	ANO
Q7	2006/2015
A3	2004/2012
A4	2001

TRAS 13"

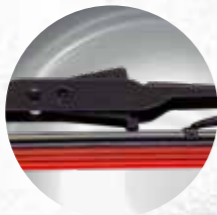

YN-PR1235 | CONEXÃO **B**

MODELO	ANO
A3	1996/2006
A6 AVANT2	2005/2008

TRAS 15"



YN-PR1242 | CONEXÃO **B**

MODELO	ANO
A1	2010

TRAS 14"



YN-PR1243 | CONEXÃO **B**

MODELO	ANO
Q5	2011/2018
	2012/2014
	2012/2017
	2006/2014

TRAS 13"



GENERAL MOTORS



YN-PR1208 | CONEXÃO **B**

MODELO	ANO
CORSA D	2007
INSIGNLA ST	****

TRAS 14"



YN-PR1209 | CONEXÃO **B**

MODELO	ANO
VECTRA GT	2007/2012
CORSA E	2014/2018
ASTRA H HATCH	2004/2009
ASTRA H	1998
ASTRA 5D	2005

TRAS 12"

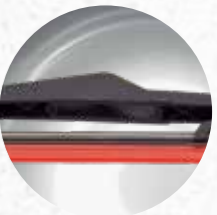

YN-PR1212 | CONEXÃO **B**

MODELO	ANO
SPIN	2012

TRAS 10"

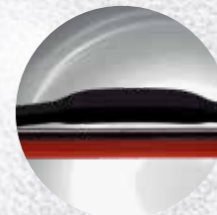

YN-PR1216 | CONEXÃO **B**

MODELO	ANO
SONIC	2012/2014

TRAS 10"

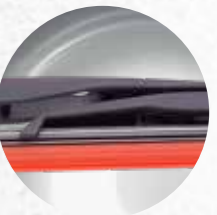

YN-PR1224 | CONEXÃO **B**

MODELO	ANO
TAHOE	2007
TRAIL BLAZER	2007/2009

TRAS 12"

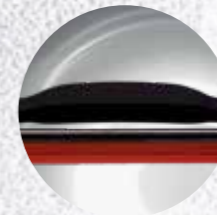

YN-PR1232 | CONEXÃO **B**

MODELO	ANO
CARAVAN GANCHO	1989/1992
CARAVAN BAIONETA	1975/1988
COMODORO BAIONETA	1968/2024
COMODORO GANCHO	1975/1988
DIPLOMATA BAIONETA	1968/1988
DIPLOMATA GANCHO	1989/1992
OPALA BAIONETA	1968/1988
OPALA GANCHO	1989/1992
VERANELO BAIONETA	1964/1988
PICKUP	1964/1985

TRAS 12"



GENERAL MOTORS



YN-PR1233 | CONEXÃO B

MODELO	ANO
BLAZER	1995

TRAS. 13"



YN-PR1234 | CONEXÃO B

MODELO	ANO
BLAZER	1996/2012
BONANZA	1989/1994
CARAVAN	1975/1992
CORSA 4P	2001/2003
CORSA WAGON	1997/2002
IPANEMA	1990/1998
OMEGA SUPREMA	1992/1998
VERANEIO	1989/1995

TRAS. 14"



YN-PR1239 | CONEXÃO B

MODELO	ANO
TERRITORY	2004

TRAS. 12"



YN-PR1240 | CONEXÃO B

MODELO	ANO
ZAFIRA C	2011

TRAS. 14"



DICAS E CUIDADOS!

HORA DA TROCA!

Se as suas palhetas apresentarem:



PARA UMA MAIOR VIDA ÚTIL DE USO:



PARA LIMPEZA, USE APENAS ÁGUA COM UM PANO MACIO, NAS LÂMINAS.



NUNCA USE PRODUTOS QUÍMICOS, ABRASIVOS, DETERGENTES, POIS DANIFICAM AS LÂMINAS.



D: 10" - 26" T:10" - 16"
PALHETAS SILICONE



Design simplificado produzida em material de qualidade excelente!



YN-PS1610

CONEXÃO **K**

MARCA	MODELO	ANO	POLEGADAS	
			MOT.	TRAS.
	CROSSFOX	2009/2013		10"
	FOX	2009/2013		10"
	FUSCA	1976/1986	10"	10"
	GOL G5	2009/2012		10"
	GOL G6	2012/2013		10"
	GOLF G3	1993/1998		10"
	CHEVETE	1973/1995		10"
	MARAJÓ	1973/1995		10"
	CHEVY	1973/1995		10"
	UNO NOVO	2010/2013		10"

YN-PS1613

CONEXÃO **K**

MARCA	MODELO	ANO	POLEGADAS	
			MOT.	TRAS.
	GOLF G4	1998/2008		13"
	GOLF G5	2007/2009		13"
	NEW BEETLE	1998/2000		13"
	PARATI G2	1996/1999		13"
	POLO HATCH	2001/2004		13"
	VARIANT G2	1977/1983		13"
	BONANZA	1989/1994		13"
	CARAVAM	1973/1992		13"
	DIPLOMATA	1973/1992		13"
	OPALA	1973/1992		13"
	CORSA 4P	1995/2002		13"
	CORSA WAGON	1995/2002		13"
	GRAND BLAZER	1998/1999		13"
	IPANEMA	1990/1998		13"
	ÔMEGA	1992/1998		13"
	SUPREMA	1992/1998		13"
VERANEIO	1989/1995		13"	
	KA	1997/2008		13"
	KA NOVO	2008/2013		13"
	ROYALE	1991/1996		13"
	VERSALLES	1991/1996		13"
	ELBA	1984/2010		13"
	UNO	1984/2010		13"
	FIORINO	1984/2010		13"
	PREMIO	1984/2010		13"
	PALIO G1	1996/2000		13"
	YOUNG	1996/2000		13"
	SIENA	1996/2000		13"
	WEEKEND	1996/2000		13"
	CAMRY	1991/2006		13"
	CAMRY WAGON	1992/1993		13"
	PAJERO SPORT	1999/2012		13"
	TOWNER	1993/2003		13"
	BESTA	2003/2012		13"
	LAIKA	1990/1998	13"	13"
	NIVA	1990/1995	13"	13"
	IBIZA	1994/2003		13"

YN-PS1613

CONEXÃO **K**

MARCA	MODELO	ANO	MOT.	POLEGADAS PAX.	TRAS.
	CHEROKEE	1997/2001		13"	
	GRAND CHEROKEE	1997/1998		13"	
	WRANGLER	1997/2006	13"	13"	
	ATOS	1998/2001		13"	
	PRIME	1998/2001		13"	
	SANTA FÉ	2001/2013		13"	
	TUCSON	2004/2011		13"	
	PROTEGÉ	1991/2000		13"	

YN-PS1614

CONEXÃO **K**

MARCA	MODELO	ANO	MOT.	POLEGADAS PAX.	TRAS.
	GOL G4	2005/2009		14"	
	PARATI G3	1999/2005		14"	
	PARATI G4	2005/2010		14"	
	SPACEFOX	2006/2013		14"	
	DOBLO	2001/2013		14"	
	STILO	2002/2011		14"	
	PALIO G2	2001/2008		14"	
	ELX	2001/2008		14"	
	WEEKEND	2001/2008		14"	
	ADVENT TIPO	2001/2008		14"	
	FIT	2003/2008		14"	
	COROLLA	1992/2001		14"	
	WAGON	1992/2001		14"	
	RAV4	1994/2012		14"	
	206	1998/2013		14"	
	207	1998/2013		14"	
	207 WAGON	2005/2013		14"	
	405	1900/1999		14"	
	CLIO I	1994/1999		14"	
	CLIO II, CLIO III, SEDAM	1999/2013		14"	
	VERSA	2012/2013	14"		
	C3	2012/2013		14"	
	C3 XTR	2002/2011		14"	
	PICANTO	2003/2012		14"	
	J6	2011/2012	14"	14"	
	PROTEGÉ	1991/2000		14"	

YN-PS1615

CONEXÃO **K**

MARCA	MODELO	ANO	MOT.	POLEGADAS PAX.	TRAS.
	GOL G5	2005/2009		15"	
	GOL G6	2012/2013		15"	
	NEW BEETLE	1998/2000		15"	
	PASSAT	2001/2002		15"	
	VARIANT	2001/2002		15"	
	SPACEFOX	2006/2013		15"	

YN-PS1615

CONEXÃO **K**

MARCA	MODELO	ANO	MOT.	POLEGADAS PAX.	TRAS.	
	A10	1964/1985		15"	15"	
	C10	1964/1985		15"	15"	
	D10	1964/1985		15"	15"	
	D20	1964/1985		15"	15"	
	CARAVAM	1973/1992		15"	15"	
	DIPLOMATA	2000/2013		15"	15"	
	OPALA	2003/2013		15"	15"	
	CELTA	2003/2012			15"	
	CORSA NOVO	2003/2012			15"	
	MERIVA	2003/2012			15"	
	TRACKER	2000/2009			15"	
	VERANEIO	1964/1988	15"	15"		
		BELINA	1969/1977			15"
		BELINA II	1978/1991			15"
		DEL REY	1978/1991			15"
ESCORT ZETEC/SW		1997/2002			15"	
EXPLORER		1992/2000			15"	
F100			15"	15"		
	F600		15"	15"		
	F1000		15"	15"		
	SPAZIO	1977/1987	15"	15"	15"	
	PALIO III/CELEBRATION	2001/2011			15"	
	PALIO IV	2008/2011			15"	
	UNO NOVO	2010/2013		15"		
	A3	1996/2006			15"	
	A6	1994/2001			15"	
	PAJERO/PAJERO CLASSIC	1991/2000			15"	
	SADERO	2008/2013			15"	
	GRAND LIVINA/LIVINA	2009/2012			15"	
	CLARUS	1996/1999			15"	
	WAGON	1996/1999			15"	
	PICANTO	2003/2012			15"	
	FURGÃO/PICKUP/BAÚ/VAN	2009/2012	15"	15"		
	520	2010/2012			15"	
	620	2010/2012			15"	
	SUV	2010/2012			15"	
	SÉRIE 3 TOURING	1990/1999			15"	

YN-PS1616

CONEXÃO **K**

MARCA	MODELO	ANO	MOT.	POLEGADAS PAX.	TRAS.
	GOL BX/LS/CL/1000	1980/1996		16"	16"
	GOL G2	1995/1999			16"
	GOL G3	1999/2005			16"
	KOMBI	1975/2011		16"	16"
	PARATI LS/CL	1982/1996		16"	16"
	PASSAT LS	1974/1989		16"	16"
	PASSAT/VARIANT VR6	1993/2001			16"
	SAVEIRO BX/LS/CL/MI	1982/1997		16"	16"
	SAVEIRO GV	2010/2013			16"
	VOYAGE LS/CL	1982/1995		16"	16"

YN-PS1616

CONEXÃO **K**

MARCA	MODELO	ANO	MOT.	POLEGADAS PAX.	TRAS.
	A10	1985/1998		16"	16"
	C10	1985/1998		16"	16"
	D10	1985/1998		16"	16"
	D20	1985/1998		16"	16"
	ASTRA SW	1995/1997			16"
	ASTRA HATCH/SEDAM	1998/2013			16"
	BLAZER	1995/2012			16"
	BONANZA	1989/1994	16"	16"	
	CAPTIVA	2008/2012			16"
	CARAVAM/DIPLOMATA	1989/1992	16"	16"	
	CHEVETE/MARAJÓ/CHEVY	1973/1995	16"	16"	
	CORSA 2P	1994/2002			16"
	CORSA NOVO	2001/2003			16"
	D20/A20/C20	1985/1998	16"	16"	
	KADETT GSI/SPORT	1989/1998			16"
	MERIVA	2002/2003			16"
VERANEIO	1989/1995	16"	16"		
ZAFIRA	2000/2012			16"	
	BELINA	1969/1977	16"	16"	
	BELINA II/ DEL REY BELINA	1978/1991	16"	16"	
	CORCEL	1969/1977	16"	16"	
	CORCEL II	1978/1986	16"	16"	
	DEL REY	1981/1991	16"	16"	
	EXPLORER	2001/2009			16"
	FIESTA	1995/1996			16"
	FIESTA/STREET	1996/2002			16"
	GALAXIE/LANDAU LTD	1967/1983	16"	16"	
	KA NOVO	2008/2013			16"
	MAVERIK	1973/1985	16"	16"	
PAMPA	1982/1997	16"	16"		
TAURUS	1992/1996			16"	
	IDEA/ADVENTURE	2004/2010			16"
	IDEA/ADVENTURE	2010/2013			16"
	MAREA/WEEKEND	1998/2007			16"
	COROLLA FIELDER	2004/2008			16"
	COROLLA	2008/2012			16"
	HILUX/SW4	1989/2004	16"	16"	
	RAV4	2006/2012			16"
	80 AVANT	1991/1996			16"
	A4 AVANT	1995/2001			16"
	COLT	1991/1996			16"
	COLT	1995/2001			16"
	L200	1999/2007	16"	16"	
	PAJERO TR4 SPACE WAGON	2002/2012 1991/2009			16" 16"
	106	1991/1996	16"	16"	
	206/207	1995/2001			16"
	206/207 CC	2001/2012			16"
	206/207SW	2005/2013			16"
	306	1993/2001	16"	16"	
	306 SW	1993/2002			16"
	307/307SW	2005/2013			16"
307/307 SEDAM/307 SW/307CC	2006/2012			16"	
	SCENIC	1997/2010	16"	16"	
	MAXIMA	2001/2010			16"
	MURANO	2004/2007			16"
	SENTRA III	2007/2012			16"
	TIIDA/SEDAM	2007/2012			16"
	X-TRAIL	2001/2012			16"



YN-PS1616

CONEXÃO **K**

MARCA	MODELO	ANO	MOT.	POLEGADAS PAX.	TRAS.
	AX	1986/1998			16"
	BERLINGO	1997/2007			16"
	C3 PICASSO	2011/2012			16"
	C5/C5 BREAK	2001/2003			16"
	XM BREAK	1989/2000			16"
	TOPIC	1993/2003	16"	16"	16"
	TOWNER	1993/2003	16"	16"	
	BESTA	2003/2012	16"	16"	
	CARENS III	2008/2012			16"
	CARNIVAL III	2006/2011			16"
	CERATO	2004/2009			16"
	CERATO II	2009/2012			16"
	CERES/K2400	1995/1997			16"
	PICANTO	2003/2012			16"
	SPORTAGE I	1993/2004			16"
	SPORTAGE II	2005/2010	16"	16"	
SPORTAGE	2011/2013			16"	
	FACE	2010/2012			16"
	J3	2011/2012	16"	16"	
	J3 TURIN	2011/2012	16"	16"	
	LS400	1990/2000			16"
	LS430	2001/2010			16"
	GTE/GTS/GTI/GTC	1975/1990	16"	16"	
	GALLOPER	1975/1990	16"	16"	
	H100	1993/2001			16"
	HB20/HB20S	2012/2013			16"
	IX35	2010/2012			16"
	TERRACAN TUCSON	2001/2007 2004/2011			16" 16"
	626 WAGON	1992/1997			16"
	PICKUP B2200	1990/1997	16"	16"	
	PT CRUISER	2000/2011			16"

YN-PS1618

CONEXÃO **K**

MARCA	MODELO	ANO	MOT.	POLEGADAS PAX.	TRAS.
	APOLLO	1990/1992	18"	18"	
	BRASILIA	1975/1982	18"	18"	
	GOL BX/LS/CL/1000	1980/1996			18"
	PARATI LS/CL	1974/1989			18"
	POLO CLASSIC	1997/2002			18"
	QUANTUM CL	1985/1998	18"	18"	
	SANTANA CL	1984/1997	18"	18"	
	VARIANT II	1977/1983	18"	18"	
	AGILE	2010/2013			18"
	ASTRA	1994/1997	18"	18"	18"
	ASTRA SW	1995/1997	18"	18"	
	ASTRA HATCH/SEDAM	1998/2013			18"
	CELTA	2000/2013	18"	18"	
	CORSA 2P	1994/2002	18"	18"	
	CORSA 4P	1995/2002	18"	18"	
	CORSA SEDAM/PICKUP/WAGON	1995/2002	18"	18"	
	CORSA NOVO	1995/2013			18"
	CORSA NOVO/SEDAM/MONTANA	2001/2010			18"
	CRUZE COBALT	2011/2013			18"

YN-PS1618

CONEXÃO **K**

MARCA	MODELO	ANO	MOT.	POLEGADAS PAX.	TRAS.
	GRAND BLAZER	1998/1999		18"	18"
	IPANEMA	1990/1998		18"	18"
	KADETT GL	1989/1997		18"	18" 18"
	KADETT GSI/SPORT	1989/1998		18"	18"
	MONTANA NOVA	2011/2013			18"
	MONZA HATCH	1982/1996		18"	18"
	PRISMA	2006/2012		18"	18"
	SIVERALDO	1993/2002		18"	18"
	TIGRA	1997/2000		18"	18"
	ECOSPORT	2003/2012			18"
	ESCORT XR3/HOBBY	1992/1996		18"	18"
	EXPLORER	1992/2000		18"	18"
	F1000/F4000	1992/2001		18"	18"
	FUSION	2006/2011		18"	18"
	RANGER	1992/2009		18"	18"
	ROYALE/VERSALLES	1991/1996		18"	18"
	VERONA	1990/1993		18"	18"
	DOBLO	2001/2013			18"
	ELBA/UNO/FIORINO/PREMIO	1984/2010			18"
	MAREA/WEEKEND	1998/2007			18"
	PALIO I/YOUNG/SIENA/WEEKEND	1996/2000			18"
	PALIO II/ELX/WEEKEND/ADVENT	2001/2008			18"
	PALIO III/CELEBRATION	2001/2011			18"
	PALIO IV	2008/2011			18"
PALIO WEEKEND IV/ADVENTURE SIENA/STRADA	2008/2011 1996/2011			18"	
HONDA	ACCORD	1993/2003			18"
	ACCORD	2003/2008			18"
	CIVIC	1991/2000			18"
	LEGEND	1991/2009			18"
	PRELUDE	1992/1997			18"
	CAMRY	2001/2006			18"
	COROLLA/WAGON	1992/2001			18"
	COROLLA	2002/2008			18"
	COROLLA FIELDER	2004/2008			18"
	CORONA	1992/2000			18"
	HILUX	2005/2012			18"
	LAND CRUISER PRADO	2003/2009		18"	18"
	PASEO	1996/1999			18"
	PREVIA	1990/1999			18"
	RAV4	1994/2000			18"
RAV4	2000/2005			18"	
	100 AVANT	1990/1994			18"
	S6	1994/1997			18"
	ECLIPSE	1992/1995			18"
	ECLIPSE	1995/1999			18"
	GALANT	1993/1997			18"
	GALANT	1997/2004			18"
	L300	1986/2011		18"	18"
	LANCER	1986/1993		18"	18"
	LANCER	1993/1995			18"
	LANCER	1995/2002			18"
LANCER	2003/2012			18"	
	106	2001/2004			18"
	205	1983/1998		18"	18" 18"
	205 MULTIVAN	1983/1998		18"	18" 18" 18"
	309	1989/1993		18"	18"
	CLIO II/III/SEDAM	1999/2013			18"
	EXPRESS	1997/2000		18"	18"
	LAGUNA/NEVADA	1994/2001			18" 18"
	LAGUNA/NEVADA	2001/2007			18"
	350Z	2002/2011			18" 18"
	FRONTIER	2007/2012			18"
	PATHFINDER	2005/2009			18"
	PRIMERA	1990/1997			18"

YN-PS1618

CONEXÃO **K**

MARCA	MODELO	ANO	MOT.	POLEGADAS PAX.	TRAS.
	C3/C3 XTR	2002/2011			18"
	C5/C5 BREAK	2001/2003			18"
	SM	1989/2000			18"
	ZX	1991/1997			18"
	BESTA	1993/2003			18" 18"
	CARENS I/II CARNIVAL I/II MAGENTIS OPIRUS SEPHIA SHUMA I/II SORENTO SPORTAGE	2000/2006 1999/2006 2005/2012 2003/2012 1993/1997 1996/2004 2003/2009 2011/2013			18" 18" 18" 18" 18" 18"
	TIGGO	2001/2009			18"
	PLUTUS	2011/2013			18" 18"
	JOURNEY	2008/2011			18"
	320	2010/2012			18" 18"
	GT	1976/1987			18" 18"
	GTB	1977/1987			18" 18"
	CORDOBA	1993/1999			18"
	IBIZA	1994/1999			18"
	INCA	1998/2002			18"
Jeep	CHEROKEE	1993/1996			18" 18"
	CHEROKEE	1997/2001			18" 18"
	ACCENT	1994/2010			18"
	ATOS/PRIME	1998/2001			18"
	ELANTRA/SW	1990/1998			18"
	EXCEL	1990/1994			18" 18"
	EXCEL	1995/2009			18" 18"
	GALLOPER	1997/2002			18"
	H1	2006/2011			18"
	H100	1993/2001			18"
	HR	2005/2012			18"
	130/130 CW	2008/2013			18"
	SANTA FÉ	2007/2013			18"
SONATA	2010/2013			18"	
	DISCOVERY	1988/1999			18" 18"
	RANGE ROVER	1988/1994			18" 18"
	MX-3	1991/1998			18"
	MX-5 MIATA	1990/1995			18" 18"
	PICKUP B2500	1997/2000			18" 18"
	PROTEGÉ	1991/2000			18"
	M3-(E46)	2000/2006			18"
	M5	1985/1988			18" 18"
	SÉRIE 3	1998/2005			18"
	SÉRIE CABRIO	2000/2006			18"
	SÉRIE 3 COMPACTO	2001/2005			18"
	SÉRIE 3 COUPÉ	1999/2004			18"
	SÉRIE 3 TOURING	1999/2005			18"
	SÉRIE 5	1979/1988			18" 18"
SÉRIE 7	1970/1996			18" 18"	

YN-PS1618

CONEXÃO **K**

MARCA	MODELO	ANO	MOT.	POLEGADAS PAX.	TRAS.
	CARAVAN/GRAND CARAVAN	1996/2007		18"	18"
	NEON I	1994/2000		18"	
	PT CRUISER	2000/2011		18"	
	VOTAGE II	1996/2002		18"	18"
	KORANDO	1996/2005	18"	18"	
	MUSSO	1993/2005		18"	
	KYRON	2005/2011		18"	

YN-PS1619

CONEXÃO **K**

MARCA	MODELO	ANO	MOT.	POLEGADAS PAX.	TRAS.
	BORA	1998/2011		19"	
	GOL G3	1999/2005		19"	
	GOL G4	2005/2009		19"	
	GOLD G3	1993/1998		19"	
	GOLF G4	1998/2008		19"	
	GOLF G5	2007/2009		19"	
	NEW BEETLE	1998/2000		19"	
	PARATI II	1996/1999		19"	
	PARATI IV	2005/2010		19"	
	POLO HATCH	2001/2012		19"	
	POLO SEDAM	2002/2012		19"	
	SAVEIRO G3	2000/2005		19"	
	SAVEIRO G4	2005/2010		19"	
	ÔMEGA/SUPREMA	1992/1998	19"	19"	
	ÔMEGA AUSTRALIANO	1999/2007		19"	
	TRACKER	2000/2009	19"	19"	
	VECTRA	1993/2005	19"	19"	
	VECTRA	2006/2008		19"	
	COURIER	1997/2013	19"	19"	
	FIESTA	1995/1996	19"	19"	
	FIESTA/STREET	1996/2002	19"	19"	
	FIESTA ROCAM	2002/2005		19"	
	FIESTA NOVO/SEDAM	2005/2013		19"	
	FOCUS HATCH	2000/2007		19"	
	KA	1997/2008	19"		
	KA NOVO	2008/2013	19"		
	ACCORD	1989/2013		19"	
	CIVIC	2001/2006		19"	
	CR-V	1995/2001	19"	19"	
	CR-V	2002/2013		19"	
	CAMRY	1991/2001		19"	
	CAMRY WAGON	1992/1993		19"	
	CELICA	1993/1999		19"	
	HILUX/SW4	2005/2012		19"	
	A3	1996/2006		19"	
	S3	1999/2003		19"	
	COLT	1995/2000		19"	
	ECLIPSE	1995/1999	19"	19"	
	GALANT	1993/2004		19"	
	PAJERO/PAJERO CLASSIC	1991/2000	19"	19"	
	PAJERO TR4	2002/2012	19"	19"	
	SPACE WAGON	1991/2009		19"	
	FRONTIER	1997/2007	19"	19"	
	PRIMERA	1990/1997		19"	
	SENTRA I	1995/1997		19"	
	SENTRA II	2005/2006		19"	
	X-TERRA	2003/2008	19"	19"	
	145	1995/2001		19"	
	166	1998/2007		19"	

YN-PS1619

CONEXÃO **K**

MARCA	MODELO	ANO	MOT.	POLEGADAS PAX.	TRAS.
	CLARUS/WAGON	1996/2007		19"	
	MAGENTIS	1994/2000		19"	
	SEPHIA	2000/2011		19"	
	SHUMA I/II	1996/2002		19"	
	CIELO	2010/2012		19"	
	ES 300	1992/2011		19"	
	CORDOBA	2000/2002		19"	
	IBIZA	2000/2003		19"	
	CHEROKEE/SPORT	2002/2011	19"	19"	
	PARIOT	2002/2010	19"	19"	
	LIBERTY	2002/2011	19"	19"	
	COUPÉ	1996/2009		19"	
	DEFENDER	1990/2010		19"	
	626 WAGON	1992/1997		19"	
	ACTION/ACTION SPORT	2006/2011		19"	

YN-PS1620

CONEXÃO **K**

MARCA	MODELO	ANO	MOT.	POLEGADAS PAX.	TRAS.
	GOL G2	1995/1999	20"	20"	
	LOGUS	1993/1997	20"	20"	
	POINTER	1994/1996	20"	20"	20"
	POLO CLASSIC	1997/2002		20"	
	QUANTUM MI	1998/2002		20"	20"
	SANTANA MI	1997/2006		20"	20"
	SAVEIRO G2	1997/2000		20"	20"
	ASTRA HATCH/SEDAM	1998/2013		20"	
	BLAZER	1995/2012		20"	
	CORSA NOVO	2001/2003		20"	
	CORSA NOVO SEDAM/MONTANA	2001/2010		20"	
	MONZA HATCH	1982/1996		20"	
	S10	1995/2011		20"	
	TIGRA	1997/2000		20"	
	ESCORT XR3/HOBBY	1992/1996		20"	
	ESCORT XR3/GL/RACER	1993/1996	20"	20"	
	ESCORT ZETEC/SW	1997/2002	20"	20"	
	FOCUS HATCH	2000/2007		20"	
	MUSTANG	1994/2004	20"	20"	
	TAURUS	1992/1996	20"	20"	
	VERONA	1993/1996	20"	20"	
	TEMPRA/SW	1992/1999		20"	
	TIPO	1994/1997		20"	
	CIVIC	1991/2000		20"	
	LEGEND	1991/2009		20"	
	PRELUDE	1992/1997		20"	
	A4 AVANT	1995/2001	20"	20"	
	S4	1994/1997	20"	20"	

YN-PS1620

CONEXÃO **K**

MARCA	MODELO	ANO	MOT.	POLEGADAS PAX.	TRAS.
	COROLLA/WAGON	1992/2001		20"	
	CORONA	1992/2000		20"	
	HILUX	2005/2012		20"	
	PASEO	1996/1999		20"	
	PREVIA	1990/1999		20"	
	RAV4	1994/2000		20"	
	COLT	1991/1995		20"	
	ECLIPSE	1992/1995		20"	20"
	L200 SPORT/OUTDOOR/SAVANA	2004/2012		20"	
	LANCER	1993/1995		20"	20"
	PAJERO SPORT	1999/2007		20"	
	PAJERO SPORT	1999/2012		20"	20"
	2001/2004	1995/2001		20"	
		1998/2007			
	19/SEDAM	1989/1997		20"	20" 20"
	21/NEVADA	1989/1994		20"	20"
	CLIO I	1994/1999		20"	20"
	CLIO II/III/SEDAM	1999/2013		20"	
	DUSTER	2012/2013		20"	20"
	KANGOO/EXPRESS	1997/2011		20"	20"
	LOGAN	2007/2013		20"	20"
	SANDEIRO	2008/2013		20"	20"
	350Z	2002/2011		20"	
	BX	1989/1993		20"	20" 20"
	155	1992/1997		20"	20"
	164	1987/1998		20"	20"
	BESTA	1993/2003		20"	
	SOUL	2009/2013		20"	
	SPORTAGE I	1993/2004		20"	20"
	DAKOTA	1995/2003		20"	20"
	RAM	1993/2001		20"	20"
	CORDOBA	1993/1999		20"	
	IBIZA	1994/1999		20"	
	INCA	1998/2002		20"	
	F355 BERLINETA	1994/1998		20"	20"
	TESTAROSSA	1986/1991		20"	20"
	348	1990/1994		20"	20"
	GRAND CHEROKEE	1993/1998		20"	20"
	ACCENT	1994/2010		20"	
	ATOS/PRIME	1998/2001		20"	
	AZERA	2007/2011		20"	
	EXCEL	1995/2009		20"	
	H1	2006/2011		20"	
	HR	2005/2012		20"	
	SANTA FÉ	2001/2006		20"	20"
	SONATA	1993/1998		20"	20"
TERRACAN	2001/2007		20"		
	626	2000/2007		20"	20"
	MX-3	1991/1998		20"	20"
	PROTEGÉ	1991/2000		20"	20"

YN-PS1620

CONEXÃO **K**

MARCA	MODELO	ANO	MOT.	POLEGADAS PAX.	TRAS.
	M ROADSTER	1999/2003		20"	20"
	SÉRIE 3 COMPACTO	1994/2001		20"	20"
	SÉRIE 3 TOURING	1990/1999		20"	20"
	Z3	1995/2003		20"	20"
	NEON I	1994/2000		20"	
	NEON II	1999/2005			20"
	MUSSO	1993/2005		20"	
	REXTON	2001/2011		20"	20"







YN-PS1621

CONEXÃO **K**

MARCA	MODELO	ANO	MOT.	POLEGADAS PAX.	TRAS.
	BORA	1998/2011		21"	
	GOL G3	1999/2005		21"	
	GOL G4	2005/2009		21"	
	GOLF G4	1998/2008		21"	
	GOLF G5	2007/2009		21"	
	NEW BEETLE	1998/2000		21"	
	NEW BEETLE	2000/2012		21"	21"
	PARATI I	1996/1999		21"	
	PARATI III	1999/2005		21"	21"
	PASSAT/VARIANT VR6	1993/2001		21"	21"
	PASSAT/VARIANT	2001/2002		21"	21"
	POLO HATCH	2001/2012		21"	
	POLO SEDAN	2002/2012		21"	
	SAVEIRO G3	2000/2005		21"	
SAVEIRO G4	2005/2010		21"		
	AGILE	2010/2013		21"	
	ÔMEGA/AUSTRALIANO	1999/2007		21"	
	STILO	2002/2011		21"	
	ACCORD	1989/1992		21"	
	CIVIC	2001/2006		21"	
	CR-V	2002/2013		21"	
	CAMRY	1991/2001		21"	
	CAMRY WAGON	1992/1993		21"	
	CELICA	1993/1999		21"	
	HILUX/SW4	2005/2012		21"	
	80 AVANT	1991/1996		21"	21"
	80 CABRIOLET	1991/1998		21"	21"
	A3	1996/2006		21"	
	S3	1999/2003		21"	
	TT COUPÉ/ROADSTER	1998/2011		21"	21"
	AIRTREK	2003/2011		21"	
	COLT	1995/2000		21"	
	GALANT	1993/1997		21"	
	LANCER	1995/2002		21"	
	PRIMERA	1990/1997		21"	
	SENTRA I	1995/1997		21"	
	VERSA	2012/2013		21"	
	145	1995/2001		21"	
	156	2002/2005		21"	21"
	166	1998/2007		21"	
	CLARUS/WAGON	1996/1999		21"	
	SEPHIA	1993/1997		21"	
	SHUMA I/II	1996/2004		21"	
	CIELO	2010/2012		21"	

YN-PS1621

CONEXÃO **K**

MARCA	MODELO	ANO	MOT.	POLEGADAS PAX. TRAS.
	ES300	1992/1996		21"
	CORDOBA	2000/2002		21"
	SONATA TERRACAN	1999/2004 2001/2007		21" 21"
	DEFENDER	1990/2010		21"
	626 WAGON	1992/1997		21"
	M3-(E36)	1994/1998		21" 21"
	NEON II	1999/2005		21"



YN-PS1622

CONEXÃO **K**

MARCA	MODELO	ANO	MOT.	POLEGADAS PAX. TRAS.
	CROSSFOX/FOX SAVEIRO G5 SPACEFOX	2003/2013 2010/2013 2006/2013		22" 22" 22"
	FIESTA ROCAM FIESTA NOVO/SEDAM FOCUS HATCH	2002/2005 2005/2013 2000/2007		22" 22" 22"
	DOBLO DUCATO	2001/2013 1998/2013		22" 22" 22"
HONDA	ODYSSEY	1995/2000		22"
	ODYSSEY	1995/2000		22" 22"
	405 605 BOXER PARTNER	1990/1999 1998/2010 1996/2010 2010/2012		22" 22" 22" 22"
	XM XM BREAK ZX	1989/2000 1989/2000 1991/1997		22" 22" 22"
	PICANTO	2003/2012		22"
	FACE	2010/2012		22"
	J3 J3 TURIN	2011/2012 2011/2012		22" 22"
Jeep	GRAND CHEROKEE LAREDO	1999/2011		22"
	RANGER ROVER	1994/2002		22"

YN-PS1622



CONEXÃO **K**

MARCA	MODELO	ANO	MOT.	POLEGADAS PAX. TRAS.
	X5	2000/2007		22"
	300C 300C TOURING 300M SEGRING STRATUS VOTAGE II	2004/2011 2004/2011 1998/2004 2001/2006 1995/2001 1996/2002		22" 22" 22" 22" 22" 22"



YN-PS1623

CONEXÃO **K**

MARCA	MODELO	ANO	MOT.	POLEGADAS PAX. TRAS.
	AMAROK GOL G5 GOL G4	2009/2012 2012/2013		23" 23"
	MERIVA VECTRA ZAFIRA	2002/2012 2006/2008 2000/2012		23" 23"
	EXPLORER FUSION	2001/2009 2006/2011		23" 23"
	MAREA/WEEKEND PALIO I/YOUNG/SIENA/WEEKEND PALIO II/ELX/WEEKEND/ADVENT PALIO III/CELEBRATION PALIO IV PALIO WEEKEND IV/ADVENTURE SIENA/STRADA UNO NOVO	1998/2007 1996/2000 2001/2008 2001/2011 2008/2011 2008/2011 1996/2011 2010/2013		23" 23" 23" 23" 23" 23" 23"
HONDA	ACCORD	1993/2003		23"
	GALANT L200 TRITON SPACE WAGON	1997/2004 2008/2012 1991/2009		23" 23" 23"
	GRAND LIVINA/LIVINA SENTRA II	2009/2012 2005/2006		23" 23"
	C3/C3 XTR	2002/2011		23"
	MAGENTIS RIO	2001/2005 2008/2011		23" 23"
	520 620 SUV	2010/2012 2010/2012 2010/2012		23" 23" 23"
	ES300 LS400	1996/2011 1990/2000		23" 23"
	COUPÉ H100	1996/2009 1993/2001		23" 23"
	M3-(E46) SÉRIE 3 SÉRIE 3 CABRIO SÉRIE 3 COMPACTO SÉRIE 3 COUPÉ SÉRIE 3 TOURING SÉRIE 5 SÉRIE 7 SÉRIE 8	2000/2006 1998/2005 2000/2006 2001/2005 1999/2004 1999/2004 1988/1996 1996/1994 1989/1999		23" 23" 23" 23" 23" 23" 23" 23" 23" 23" 23" 23"

YN-PS1623

CONEXÃO K

MARCA	MODELO	ANO	MOT.	POLEGADAS	PAX.	TRAS.
	ACTYON/ACTYON SPORT	2006/2011		23"		

YN-PS1624

CONEXÃO K

MARCA	MODELO	ANO	MOT.	POLEGADAS	PAX.	TRAS.
	CAPTIVA CRUZE/COBALT	2008/2012 2011/2013		24"		
	IDEA/ADVENTURE	2004/2013		24"		
	ACCORD ODYSSEY	2003/2008 1995/2000		24"		
	CAMRY COROLLA COROLLA FIELDER RAV4	2001/2006 2002/2008 2004/2008 2000/2012		24"		
	100 AVANTE A6 A6 AVANTE A8 S4 S6 S8	1990/1994 1994/2001 1997/2004 1994/2002 1991/1994 1994/1997 1996/2002		24"		
	LANCER	2003/2012		24"		
	405 605 BOXER PARTNER	1990/1999 1990/1999 1998/2010 1996/2012		24"		
	LAGUNA/NEVADA MASTER SCENIC	1994/2007 2002/2013 1997/2010		24"	24"	
	AX BERLINGO C5/C5 BREAK XM XM BREAK ZX	1986/1998 1997/2007 2001/2003 1989/2000 1989/2000 1991/1997		24"		
	CARENS I/II CARNIVAL I/II CARNIVAL III CERATO CERATO II MAGENTIS OPIRUS SORENTO SOUL SPORTAGE SPORTAGE II	2000/2006 1999/2006 2006/2011 2004/2009 2009/2012 2005/2012 2003/2012 2003/2009 2009/2013 2011/2013 2005/2010		24"	24"	24"
	TIGGO	2001/2009		24"		
	JOURNEY RAM	2008/2011 2004/2012		24"	24"	24"
	J6	2011/2012		24"		

YN-PS1624

CONEXÃO K

MARCA	MODELO	ANO	MOT.	POLEGADAS	PAX.	TRAS.
	LS430	2003/2010		24"		
	AZERA HB20/HB20S I30/I30 CW IX 35 SANTA FÉ TUCSON	2007/2011 2012/2013 2008/2013 2010/2012 2007/2013 2004/2011		24"		
	RANGER ROVER RANGER ROVER (SPORT)	1994/2002 2006/2010		24"		
	X5	2000/2007		24"		
	300C 300C TOURING 300M SEGRING STRATUS VOTAGE II	2004/2011 2004/2011 1998/2004 2001/2006 1995/2001 1996/2002		24"		

YN-PS1626

CONEXÃO K

MARCA	MODELO	ANO	MOT.	POLEGADAS	PAX.	TRAS.
	ACCORD	2009/2013		26"		
	COROLLA	2008/2012		26"		
	CARAVAN/GRAND CARAVAN	1996/2007		26"	26"	
	206/207 206/207 CC 206/207SW 306 306 SW 307/307 SW 307/307 SEDAM/307 SW/307 CC	1998/2013 2001/2012 2005/2013 1993/2001 1993/2002 2001/2005 2006/2012		26"	26"	26"
	TWINGO	1993/2007		26"	26"	
	MAXIMA MURANO SENTRA III	2001/2010 2004/2007 2007/2012		26"		
	C3 PICASSO	2011/2012		26"	26"	
	CARENS III	2008/2012		26"		
	LS430	2001/2002		26"		
	SONATA	2010/2013		26"		
	RANGER ROVER	2002/2005		26"	26"	

YN-PST10

CONEXÃO K

MARCA	MODELO	ANO	MOT.	POLEGADAS PAX.	TRAS.
	CROSSFOX/FOX	2009/2013		10"	
	GOL G5	2009/2012		10"	
	GOL G6	2012/2013		10"	
	GOLF G3	1993/1998		10"	

YN-PST12

CONEXÃO K

MARCA	MODELO	ANO	MOT.	POLEGADAS PAX.	TRAS.
	CROSSFOX/FOX	2003/2009		12"	
	QUANTUM CL	1985/1998		12"	
	QUANTUM MI	1998/2002		12"	
	AGILE	2010/2013		12"	
	ECOSPORT	2003/2012		12"	
	FIESTA ROCAM	2002/2005		12"	
	FIESTA NOVO/SEDAM	2005/2013		12"	
	OGGI/PANORAMA/SPAZIO	1982/1996		12"	
	TEMPRA/SW	1992/1999		12"	
	TWINGO	1993/2007		12"	
	SOUL	2009/2013		12"	
	LAIKA	1990/1998		12"	





YN-PST13

CONEXÃO K

MARCA	MODELO	ANO	MOT.	POLEGADAS PAX.	TRAS.
	GOLF G4	1998/2008		13"	
	GOLF G5	2007/2009		13"	
	NEW BEETLE	1998/2000		13"	
	PARATI II	1996/1999		13"	
	POLO HATCH	2001/2004		13"	
	VARIANT II	1977/1983		13"	
	BONANZA	1989/1994		13"	
	CARAVAM/DIPLOMATA/OPALA	1973/1992		13"	
	CARAVAM/DIPLOMATA	1989/1992		13"	
	CORSA 4P	1995/2002		13"	
	CORSA WAGON	1995/2002		13"	
	GRAND BLAZER	1998/1999		13"	
	IPANEMA	1990/1998		13"	
	KA	1997/2008		13"	
	KANOVO	2008/2013		13"	
	ROYALE/VERSALLES	1991/1996		13"	
	ELBA/UNO/FIORINO/PREMIO	1984/2010		13"	
	PALIO I/YOUNG/SIENA/WEEKEND	1996/2000		13"	
HONDA	CR-V	1995/2001		13"	
	CAMRY	1991/2001		13"	
	CAMRY	2001/2006		13"	
	CAMRY WAGON	1992/1993		13"	
	PAJERO SPORT	1999/2012		13"	

YN-PST13

CONEXÃO K

MARCA	MODELO	ANO	MOT.	POLEGADAS PAX.	TRAS.
	TOWNER	1993/2003		13"	
	BESTA	2003/2012		13"	
	IBIZA	1994/2003		13"	
	CHEROKEE GRAND CHEROKEE	1997/2001 1993/1998		13" 13"	
	ATOS/PRIME	1998/2001		13"	
	SANTA FÉ	2001/2013		13"	
	TUCSON	2004/2011		13"	
	PROTEGÉ	1991/2000		13"	



YN-PST14

CONEXÃO K

MARCA	MODELO	ANO	MOT.	POLEGADAS PAX.	TRAS.
	PARATI III	1999/2005		14"	
	PARATI IV	2005/2010		14"	
	SPACEFOX	2006/2013		14"	
	DOBLO	2001/2013		14"	
	PALIO II/ELX/WEEKEND/ADVENT	2001/2008		14"	
	STILO	2002/2011		14"	

YN-PST14

CONEXÃO K

MARCA	MODELO	ANO	MOT.	POLEGADAS PAX.	TRAS.
	PARATI III	1999/2005		14"	
	PARATI IV	2005/2010		14"	
	SPACEFOX	2006/2013		14"	
	DOBLO	2001/2013		14"	
	PALIO II/ELX/WEEKEND/ADVENT	2001/2008		14"	
	STILO	2002/2011		14"	
HONDA	FIT	2003/2008		14"	
	COROLLA/WAGON	1992/2001		14"	
	206/207 SW 405	2005/2013 1990/1999		14" 14"	
	CLIO I	1994/1999		14"	
	CLIO II/III/SEDAM	1999/2013		14"	
	C3/C3 XTR	2002/2011		14"	
	PICANTO	2003/2012		14"	
	J6	2011/2012		14"	

YN-PST15

CONEXÃO K

MARCA	MODELO	ANO	POLEGADAS	
			MOT.	PAX. TRAS.
	CORSA NOVO	2003/2013	15"	
	MERIVA	2003/2012	15"	
	TRACKER	2000/2009	15"	
	BELINA	2003/2013	15"	
	BELINA II/DEL REY BELINA	2003/2012	15"	
	ESCORT ZETEC/SW	2000/2009	15"	
	EXPLORER			
	CORSA NOVO	2003/2013	15"	
	MERIVA	2003/2012	15"	
	TRACKER	2000/2009	15"	
	147 - SPAZIO	1977/1987	15"	
	PALIO III/CELEBRATION	2001/2011	15"	
	PALIO IV	2008/2011	15"	
	A3	1996/2006	15"	
	A6 AVANTE	1997/2004	15"	
	PAJERO/PAJERO CLASSIC	1991/2000	15"	
	SANDEIRO	2008/2013	15"	
	CLARUS/WAGON	1996/1999	15"	
	SÉRIE TOURING	1990/1999	15"	









YN-PST16

CONEXÃO K

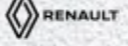
MARCA	MODELO	ANO	POLEGADAS	
			MOT.	PAX. TRAS.
	PASSAT/VARIANT VR6	1993/2001	16"	
	ASTRA SW	1995/1997	16"	
	ASTRA HATCH/SEDAM	1998/2013	16"	
	BLAZER	1995/2012	16"	
	CORSA NOVO	2001/2003	16"	
	KADETT GSI/SPORT	1989/1998	16"	
	MERIVA	2002/2003	16"	
ZAFIRA	2000/2012	16"		
	EXPLORER	2001/2009	16"	
	FIESTA	1995/1996	16"	
	FIESTA/STREET	1996/2002	16"	
	TAURUS	1992/1996	16"	
	IDEA/ADVENTURE	2004/2013	16"	
	MAREA/WEEKEND	1998/2007	16"	
HONDA	ODYSSEY	1995/2000	16"	
	COROLLA FIELDER	2004/2008	16"	
	626 WAGON	1992/1997	16"	
	PT CRUISER	2000/2011	16"	

YN-PST16

CONEXÃO K

MARCA	MODELO	ANO	POLEGADAS	
			MOT.	PAX. TRAS.
	80 AVANTE	1991/1996	16"	
	A4 AVANTE	1995/2001	16"	
	COLT	1991/2000	16"	
	PAJERO TR4	2002/2012	16"	
	SPACE WAGON	1991/2009	16"	
	306	1993/2001	16"	
	306 SW	1993/2002	16"	
	307/307 SW	2001/2005	16"	
	307/307 SEDAM/307 SW/307 CC	2006/2012	16"	
	SCENIC	1997/2010	16"	
	C3 PICASSO	2011/2012	16"	
	C5/C5 BREAK	2001/2003	16"	
	TOPIC	1993/2003	16"	
	CARNIVAL III	2006/2011	16"	
	SPORTAGE	1993/2004	16"	
	SPORTAGE I	2005/2010	16"	
	SPORTAGE II	2011/2013	16"	
	J3	2011/2012	16"	
	J3 TURIN	2011/2012	16"	
	H100	1993/2001	16"	
	TERRACAN	2001/2007	16"	





10" - 14" PALHETAS TRASEIRA COM BRAÇO



Design simplificado
produzida em material
de qualidade excelente!

YN-PSP01

ENCAIXE U

MARCA	MODELO	ANO	POL.
	PALIO	1996/2016	14"



YN-PSP03

ENCAIXE U

MARCA	MODELO	ANO	POL.
	PALIO WEEKEND	1996	14"



YN-PSP1779

ENCAIXE U

MARCA	MODELO	ANO	POL.
	PALIO	1996/2016	14"



YN-PSP1785

ENCAIXE U

MARCA	MODELO	ANO	POL.
	IDEA	2011/2016	12"



YN-PSP1862

ENCAIXE U

MARCA	MODELO	ANO	POL.
	DOULO	2001	14"



YN-PSP1413

ENCAIXE U

MARCA	MODELO	ANO	POL.
	ECO SPORT	2013/2016	10"



YN-PSP1786

ENCAIXE U

MARCA	MODELO	ANO	POL.
	KA	2008/2013	12"



YN-PSP06

ENCAIXE U

MARCA	MODELO	ANO	POL.
	FIESTA 6 VI	2008/2017	12"





YN-PSP1127 ENCAIXE U

MARCA	MODELO	ANO	POL.
 FIESTA 6 VI		2011	12"





YN-PSP1343 ENCAIXE U

MARCA	MODELO	ANO	POL.
 FOCUS		2011	14"



YN-PSP1344 ENCAIXE U

MARCA	MODELO	ANO	POL.
 FOCUS		2011	12"



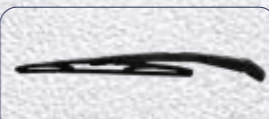

YN-PSP04 U

MARCA	MODELO	ANO	POL.
 POLO GOL GL8		**** 2006/2016 ****	16"





YN-PSP1345 U

MARCA	MODELO	ANO	POL.
 UP		2011	10"





YN-PSP1404 U

MARCA	MODELO	ANO	POL.
 GOL G4		2011	14"





YN-PSP1405 U

MARCA	MODELO	ANO	POL.
 FOX / SPACE FOX GOL G5 / G6		**** ****	10"



YN-PSP1407 U

MARCA	MODELO	ANO	POL.
 ONIX		2012	12"



YN-PSP1408 ENCAIXE U

MARCA	MODELO	ANO	POL.
 HONDA	FIT	2003/2008	14"



YN-PSP1409 ENCAIXE U

MARCA	MODELO	ANO	POL.
 HONDA	FIT	2009/2014	14"



YN-PSP1410 ENCAIXE U

MARCA	MODELO	ANO	POL.
 HONDA	FIT	2015	14"



YN-PSP1411 U

MARCA	MODELO	ANO	POL.
 HONDA	CRV	2008/2013	14"



YN-PSP1412 U

MARCA	MODELO	ANO	POL.
 HONDA	CRV	2014	14"



YN-PSP1406 U

MARCA	MODELO	ANO	POL.
 PEUGEOT	PEUGEOT 206	1998	14"



YN-PSP1486 U

MARCA	MODELO	ANO	POL.
 PEUGEOT	PGT 307	2006	14"



YN-PSP1487 U

MARCA	MODELO	ANO	POL.
 PEUGEOT	PGT 308	2012	12"



YN-PSP05

ENCAIXE **U**

MARCA	MODELO	ANO	POL.
 CORSA E		2014	12"



YN-PSP1488

ENCAIXE **U**

MARCA	MODELO	ANO	POL.
 RAV4		2014	10"



YN-PSP1489

ENCAIXE **U**

MARCA	MODELO	ANO	POL.
 HULUX SW4		2006/2016	12"



YN-PSP1490

ENCAIXE **U**

MARCA	MODELO	ANO	POL.
 MARCH		2011	12"



YN-PSP1491

ENCAIXE **U**

MARCA	MODELO	ANO	POL.
 CLIO2		1998/2005	12"



YN-PSP1492

ENCAIXE **U**

MARCA	MODELO	ANO	POL.
 DUSTER		2011	12"



YN-PSP1493

ENCAIXE **U**

MARCA	MODELO	ANO	POL.
 SANDERO		2015	12"



**NÃO HÁ
TEMPO RUIM
COM AS
PALHETAS
CINOY!**



CINOY
 PRODUTOS AUTOMOTIVOS

13" - 40"

PALHETAS CAMINHÃO

UNIVERSAL



YN-PC1359

CONEXÃO **K**

MARCA	MODELO	ANO	POL.
	6000 CS 2P	1992/2012	14"
	7000 DX 2P	1992/2005	
	7500 TDX 2P	1992/2005	
	8500 TD	1997/2003	
	MA7 5T	1992/2005	
	CAMINHÕES - CARA CHATA 709, 710, 711, 712, 912, 914, 915, 916, 1114	1988/2024	14"
	CAMINHÕES 712C, 914C, 1935, 1941	1988/2024	
	CAMINHÕES - SÉRIE L	1988/2000	
	CAMINHÕES SÉRIE - T/R	1981/1990	14"
	CAMINHÕES 7-100, 8-140, 12-140, 12-170, 14-150, 14-200, 16-170, 16-200, 16-220, 24-220, 35-300	1992/1999	14"
		1992/1999	
	ESCAVADEIRA 230C, 320DL, 336DL	1950/2024	14"
	PÁ CARREGADEIRA 938H	1950/2024	
	PÁ CARREGADEIRA HL7407A	1950/2024	14"
	ESCAVADEIRA PC200	1950/2024	14"
	ESCAVADEIRA 908E	1950/2024	14"
	PÁ CARREGADEIRA 856H	1950/2024	
	MOTONIVELADORA 919	1950/2024	14"
	PÁ CARREGADEIRA 638, 616B, 618D	1950/2024	



YN-PC1360



CONEXÃO **K**

MARCA	MODELO	ANO	POL.
	T4	2004/2014	14"

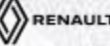

YN-PC1361

CONEXÃO **K**

MARCA	MODELO	ANO	POL.
	DAILY	2007/2024	14"
	MASTER	1997/1999	14"
	YUAN PLUS		
	SPACE	1991/1996	14"
	CAMINHÕES VM, VM270, VM260, VM310, VM17, VM23	2003/2024	14"



Design simplificado
 produzida em material
 de qualidade excelente!

YN-PC1364







CONEXÃO K

MARCA	MODELO	ANO	POL.
 Volkswagen	CAMINHÕES CONSTELATION	2006/2024	14"



YN-PC1365

CONEXÃO K

MARCA	MODELO	ANO	POL.
	URBANO	2006/2024	14"
	AMÉLIA SPN PADRON VOLVO TROLEBUS RIBEIRÃO PRETO	2006/2024	
	DINOSSAURO	1983/2022	
	CAMINHÕES CONSTELATION	2006/2024	
	CITY BUS URBANO	1995/2024	
Mafersa	METRÔ SÃO PAULO	2006/2024	
	PARADISO SAIA 1450/O-370 INF. G4 PARADISO SAIA 1450 VOLVO INF. G4 STRADA SAIA 850/950/1100 TORINO RS G4 TORINO VIAGGIO	1984/1991 1990/1991 1984/1991 1984/1991 1991/2024 1984/1991	
	D-364 0-364	1949/1984 1985/2024	
	NEOBUS FALCON PADRON CTC THAMCO	1986/2024 1985/2024 1986/2024	



YN-PC1366



CONEXÃO K

MARCA	MODELO	ANO	POL.
	ACELLO 715C SÉRIE L FH	2003 1988/1995 2007	14"



YN-PC1367

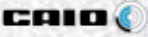



CONEXÃO K

MARCA	MODELO	ANO	POL.
	URBANO	1985/2024	14"
	AMÉLIA SPN PADRON VOLVO SE TROLEBUS RIBEIRÃO PRETO	1983/2024 1983/2024 1992/2024	
	DINOSSAURO	1983/2024	



YN-PC1367

CONEXÃO K

MARCA	MODELO	ANO	POL.
	D-364 0-364	1949/1984 1985/2024	14"
	NEOBUS FALCON PADRON CTC THAMCO	1986/2024 1985/2024 1986/2024	
	PARADISO SAIA 1450/O-370 INF G4 PARADISO SAIA 1450/VOLVO INF G4 STRADA SAIA 850/950/1100 TORINO RS G4 TORINO VIAGGIO	1984/1991 1990/1991 1984/1991 1984/1991 1991/2024 1984/1991	
	SUPERBUS TRIBUS	1982/2024 1982/2024	
	CITY BUS URBANO	1995/2024	
Mafersa	METRÔ SÃO PAULO	1993/2024	



YN-PC1368







CONEXÃO K

MARCA	MODELO	ANO	POL.
	MICRO SENIOR	2000/2006	14"



YN-PC1369

CONEXÃO K

MARCA	MODELO	ANO	POL.
	6000 D 2P 7000 DX 2P 7500 TDX 2P 8500 TD MA7.5T	1992/2012 1992/2005 1997/2003 1992/2005	14"
	CAMINHÕES CARA CHATA 709, 710, 711, 712, 912, 914, 915, 916, 1114 CAMINHÕES SÉRIE L CAMINHÕES 712C/914C/1935/1941	1988/2024 1988/2000 1988/2024	
	SÉRIE T/R	1981/1990	
	CAMINHÕES 7-100, 8-140, 12-140, 12-170, 14-150, 14-170, 14-220, 16-170, 16-220, 24-220, 35-300	1992/1999 1992/1999	
	ESCAVADEIRA 230C, 320DL, 336DL	1950/2024	
	PÁ CARREGADEIRA 938H	1950/2024	
	PÁ CARREGADEIRA HL7407A	1950/2024	
KOMATSU	ESCAVADEIRA PC200	1950/2024	



YN-PC1369

CONEXÃO K

MARCA	MODELO	ANO	POL.
	ESCAVADEIRA 908E	1950/2024	14"
	PÁ CARREGADEIRA 856H	1950/2024	
	MOTONIVELADORA 919	1950/2024	14"
	PÁ CARREGADEIRA 638, 616B, 618D	1950/2024	



YN-PC1370

K

MARCA	MODELO	ANO	POL.
	STRALIS	2004/2010	14"
	TECH FIRE, STAR, CAVALINHO, CURSOR	1998/2012	
	TECTOR	2004/2010	
	TRAKKER EUROARGO	2004/2012	
	ATEGO	1994/2006	14"
	AXOR	2006/2024	
	FH12	1994/2006	14"
	FM12	2000/2006	



YN-PC1371

CONEXÃO K

MARCA	MODELO	ANO	POL.
	CARGO	2011/2024	14"
	STRALIS	2008/2024	
	1938S, 1944S	1998/2024	14"
	ATEGO	1998/2024	
	AXOR	2001/2024	
	NH12	2000/2024	14"



YN-PC1372

CONEXÃO K

MARCA	MODELO	ANO	POL.
	EMPILHADEIRA T40140	2011/2024	14"
	COMPACTADOR VIBRATÓRIO DE SOLO CP54B	1950/2024	
	EMPILHADEIRA P17500	1950/2024	14"
	ROLETE AUTOMÁTICO CW34	1950/2024	
	ROLETE VIBRATÓRIO EM TANDEM CB7	1950/2024	
	ESCAVADEIRA 320	1950/2024	
	ESCAVADEIRA 320	1950/2024	14"
	PÁ CARREGADEIRA 524K, 624K, 644K, 724K	1950/2024	
	PÁ CARREGADEIRA 524K, 624K, 644K, 724K	1950/2024	14"



YN-PC1372

CONEXÃO K

MARCA	MODELO	ANO	POL.
	PÁ CARREGADEIRA 580	1950/2024	14"
	RETROESCAVADEIRA RE06	1950/2024	
	ROLO CAOMPACTADOR 8218	1950/2024	14"
	CAMINHÃO CARGO TODOS OS MODELOS ANTIGOS	1985/1992	



YN-PC1373

CONEXÃO K

MARCA	MODELO	ANO	POL.
	TGL	2011/2024	14"
	TGM	2011/2024	
	TGS	2011/2024	
	TGX/V8	2011/2024	
	ACTROS	1997/2024	14"
	SCANIA SÉRIE 5	2008/2010	
	SÉRIE 4 I T/R/P - 94/114/124	1998/2007	14"
	METEOR 28-460 / 29-520	2020/2024	
	ACTROS	1997/2024	14"
	FH540	2015/2019	



YN-PC1374

CONEXÃO K

MARCA	MODELO	ANO	POL.
	SÉRIE 5 I	2010/2018	14"
	FH NOVO	2020/2024	
	FH12	2013/2017	14"
	FH13	2013/2024	
	FH16	2013/2024	



YN-PC1375

CONEXÃO K

MARCA	MODELO	ANO	POL.
	ACTROS	2016/2024	14"



YN-PC1376

CONEXÃO K

MARCA	MODELO	ANO	POL.
	SÉRIE 5 I	2010/2018	14"
	FH NOVO	2020/2024	
	FH12	2013/2017	14"
	FH13	2013/2024	
	FH16	2013/2024	

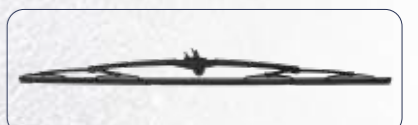

YN-PC1377



MARCA	MODELO	ANO	POL.
Marcopola	MICRO SÊNIOR	2000/2006	14"



YN-PC1378



MARCA	MODELO	ANO	POL.
AGRALE	VOLARE ÔNIBUS A6 VOLARE ÔNIBUS A8 VOLARE ÔNIBUS W6 VOLARE ÔNIBUS W7 VOLARE ÔNIBUS W8 VOLARE ÔNIBUS W9 VOLARE ÔNIBUS DW9 VOLARE ÔNIBUS WL	2001/2024 2002/2024 2004/2024 2004/2024 2005/2024 2007/2024 2009/2024 2010/2024	14"
Marcopola	AMARALINA ONDINA PIATA	1950/2024 1950/2024 1950/2024	
BUSSCAR	EL BUSS JUM BUSS 340/360/380 INFERIOR	1990/1997 1990/1997	
CAIO	ALPHA ALPHA RODOVIÁRIO APACHE VIP APACHE APACHE S 22 ARITANA CAROLINA CAROLINA BI-PARTIDO FORD MOBILE FOZ SUPER 2200 MONDEGO ARTICULADO PICOLINO PICOLO SQUALO URBANO ALPHA BI-PARTIDO ALFANA MICRO CAROLINA G3 MICRO CAROLINA G4 VITÓRIA	1986/2024 1994/2024 1988/2024 1998/2002 2007/2024 1986/2024 1985/2024 1988/2024 1994/2024 1950/2024 1950/2024 1998/2002 1998/2002 1986/2024 1995/2024 1994/2024 1986/2024 1986/2024 1986/2024	
CIFERAL	DINAMUS URBANO GENESIS PODIUM CURSOR GLS BUS PADRON PODIN	1994/2024 1994/2024 1988/1991 1993/1994 1993/1997 1992/1993	
CAIO	TROLEBUS	1994/2024 1994/2024 1988/1991	
incasel	CONDUTIERRE DOPPIO GALLEGIANTE VERSATILE	1992/2024 1996/2024 1994/2024 1996/2024	
MAFERSA	MICRO FREE WAY MIRAGE RODOVIÁRIO PRIMOS RODOVIÁRIO STILUS RODOVIÁRIO TROLEBUS RODOVIÁRIO	1950/2024 1995/2024 1995/2024 1995/2024 1994/2024 1986/2024	
MASCARELLO	GRAN MICRO GRAN VIA MIDI	2002/2024 2004/2024	

YN-PC1378



MARCA	MODELO	ANO	POL.
THAMCO	ÁGUIA FALCON PADRON PEGASUS SCORPIUM URBANO MEGA	1988/2024 1988/2024 1988/2024 1988/2024 1988/2024 1996/2024	14"
Mercedes-Benz	0370 0371/0400	1984/2024	
Volare	V6	1998/2024	
PLA	MÁQUINAS E TRATORES PULVERIZADOR H300I	1950/2024	



YN-PC1380



MARCA	MODELO	ANO	POL.
Jacto	PULVERIZADOR UNIPORT 3000 PLUS	1950/2024	14"



YN-PC1380



MARCA	MODELO	ANO	POL.
Marcopola	ÔNIBUS PARADISO G7 VIAGGIO G7	2009/2011 2009/2011	14"



YN-PC1381



MARCA	MODELO	ANO	POL.
Marcopola	SEM INFO	2009/2011 2009/2011	14"



YN-PC1382



MARCA	MODELO	ANO	POL.
CASE	COLHETADEIRAS 2388, 2399, 4130, 5130, 7130, 7230, 8230	**** ****	14"
CATERPILLAR	ESCAVADEIRA M322D	****	
JOHN DEERE	COLHETADEIRAS 1550, 5550, 5760, S540	****	
MASSEY FERGUSON	COLHETADEIRAS 32 ADVANCED 34 ADVANCED 4690, 5690, 6690, 9790	****	
NEW HOLLAND	COLHETADEIRAS TC 5070 TC 5090	****	



YN-PC1382

CONEXÃO **K**

MARCA	MODELO	ANO	POL.
 BUSSCAR	EL BUSS 340	****	14"
	VISTA BUSS 320/340		
	VISTA BUSS HI/NORUEGA		
	VISTA BUSS JI/HO		
 VALTRA	COLHETADEIRAS	****	
	BC6500		
	BC7800		



**AS MELHORES
PALHETAS PARA
LINHA PESADA!**



YN-PF0010

CONEXÃO **K**



10" - 24"

PALHETAS DE FERRO

UNIVERSAL



MARCA	MODELO	ANO
	CELTA 1.0 3P	2001/2004
	CELTA 1.0 5P	2003/2004
	CELTA ADVANTAGE FLEX POWER	2005
	CELTA 1.0 LIFE 3P	2005/2006
	CELTA 1.0 LIFE 5P	2005/2006
	CELTA 1.0 LIFE FLEX POWER 3P	2006/2011
	CELTA 1.0 LIFE FLEX POWER 5P	2006/2011
	CELTA 1.0 LIFE FLEX POWER 3P 70HP	2009
	CELTA 1.0 LIFE FLEX POWER 3P 77HP	2009
	CELTA 1.0 LIFE FLEX POWER 5P 70HP	2009
	CELTA 1.0 LIFE FLEX POWER 5P 77HP	2009
	CELTA 1.0 LS FLEX POWER 3P	2012/2014
	CELTA 1.0 LS FLEX POWER 5P	2012/2013
	CELTA 1.0 EDIÇÃO LIMIT. FLEX POWER 5P	2012
	CELTA 1.0 LT FLEX POWER 5P	2012/2015
	CELTA 1.0 SPIRIT 3P	2005
	CELTA 1.0 SPIRIT 5P	2005
	CELTA 1.0 SPIRIT FLEX POWER 3P	2006/2011
	CELTA 1.0 SPIRIT FLEX POWER 3P 70HP	2009
	CELTA 1.0 SPIRIT FLEX POWER 3P 77HP	2009
	CELTA 1.0 SPIRIT FLEX POWER 5P	2006/2011
	CELTA 1.0 SPIRIT FLEX POWER 5P 70HP	2009
	CELTA 1.0 SPIRIT FLEX POWER 5P 77HP	2009
	CELTA 1.0 SUPER 3P	2004/2005
	CELTA 1.0 SUPER 5P	2004/2005
	CELTA 1.0 SUPER FLEX POWER 3P	2006/2009
	CELTA 1.0 SUPER FLEX POWER 5P	2006/2009
	CELTA 1.4 3P	2004
	CELTA 1.4 5P	2004
	CELTA 1.4 ENERGY 3P	2004
	CELTA 1.4 ENERGY 5P	2004
	CELTA 1.4 LIFE 3P	2005/2007
	CELTA 1.4 LIFE 5P	2005/2007
	CELTA 1.0 SPIRIT 3P	2005/2007
	CELTA 1.0 SPIRIT 5P	2005/2007
	CORSA 1.0 16V SUPER 3P	1999/2000
	CORSA 1.0 5P	2002/2004
	CORSA 1.0 JOY 5P	2005
	CORSA 1.0 MAXX 5P	2005
	CORSA 1.0 PREMIUM 5P	2005
	CORSA 1.0 SUPER 3P	1999
	CORSA 1.0 SUPER 5P	2000/2002
	CORSA 1.0 SUPER 5P 60HP	1999
	CORSA 1.0 SUPER 5P 68HP	1999
	CORSA 1.0 WIND 3P	1998/2002
	CORSA 1.0 WIND 5P	1999/2000
	CORSA 1.0 WIND 5P ALCOOL	2001/2002
	CORSA 1.0 WIND 5P GASOLINA	2001/2002
	CORSA 1.0 WIND MILLENIUM 5P	2001/2002
	CORSA 1.4 GL 3P	1996
	CORSA 1.4 GL 5P	1996
	CORSA 1.6 GL 3P	1999
	CORSA 1.6 GLS 5P	1999
	CORSA 1.6 GLS 99.5 5P	2001
	CORSA 1.8 5P	2002/2003
	CORSA 1.8 FLEX POWER	2004
	CORSA 1.8 JOY FLEX POWER	2005
	CORSA 1.8 MAXX FLEX POWER	2005
	CORSA 1.8 PREMIUM	2005
	CORSA WAGON 1.0 16V SUPER 5P	1999/2001
	CORSA WAGON 1.0 SUPER 5P	2001/2002
	CORSA WAGON 1.0 16V GLS 5P	1999/2001
	CORSA WAGON 1.0 8V GLS 5P	1999/2001
	CORSA WAGON 1.6 GL 5P	1999
	CORSA WAGON 1.6 SUPER 5P	2001/2002
	GRAND BLAZER 4.1 DLX 5P	1999
	GRAND BLAZER 4.2 DLX 5P	1999
	IPANEMA 1.8 GL 5P	1997
	IPANEMA 2.0 GL 5P	1997
	KADETT 1.8 GL 3P	1998
	KADETT 2.0 GL 3P	1998

POLEGADAS
MOT. PAX.
10" 10"



Design simplificado
produzida em material
de qualidade excelente!

YN-PF0010

CONEXÃO K

MARCA	MODELO	ANO	POLEGADAS MOT. PAX. TRAS.
	PRISMA 1.0 JOY FLEX POWER 4P	2009/2011	22"
	PRISMA 1.0 LS FLEX POWER 4P	2012	22"
	PRISMA 1.0 MAXX FLEX POWER 4P	2009/2010	22"
	PRISMA 1.4 JOY ECONOFLEX 4P	2007/2008	
	PRISMA 1.4 JOY ECONOFLEX 4P 89HP	2009	
	PRISMA 1.4 JOY ECONOFLEX 4P 95HP	2009	
	PRISMA 1.4 LT ECONOFLEX 4P	2012	
	PRISMA 1.4 MAXX ECONOFLEX 4P	2010	
	PRISMA 1.4 MAXX ECONOFLEX 4P 89HP	2009	
	PRISMA 1.4 MAXX ECONOFLEX 4P 95HP	2009	
	SILVERADO 4.1 DLX 2P	1999	
	SILVERADO 4.1 STD 2P DIESEL	1999	
	SILVERADO 4.1 STD 2P GASOLINA	1999	
	SILVERADO 4.2 STD CONQUEST HD 2P	2000	
	SILVERADO 4.2 D20 2P	2001	
	SILVERADO 4.2 DIXTURBO 2P	1999	
	SILVERADO 4.2 STD 2P RODEIO 2P	1995/1997	
SILVERADO 4.2 STDTURBO 2P	1995/1997		
	CUORE 0.85 CS 5P	1995/1998	
	CUORE 0.85 CSL 5P	1995/1998	
	CUORE 0.85 TS 5P	1995/1997	
	CUORE 0.85 TSL 5P	1995/1997	
	PLUTUS 1.0	2011	
	EXPLORER 4.0 XLT 4X4 AUT. 5P	1998	
	EXPLORER 5.0 XLT 4X4 AUT. 5P	2001	
	EXPLORER 5.0 LIMITED 4X4 AUT. 5P	1999/2000	
	F-1000 4.3 XLT 4X4 2P	1998	
	RANGER 2.3 SPORT CAB. SIMPLES 4X2 2P	2010/2012	
	RANGER 2.3 XL CAB. DUPLA 4X2 2P	2001/2012	
	RANGER 2.3 XL SUPER CAB. 4X2 4P	2001/2002	
	RANGER 2.3 XLS CAB. DUPLA 4X2 4P	2004/2012	
	RANGER 2.3 XLS CAB. SIMPLES 4X2 2P	2004/2012	
	RANGER 2.3 XLS CAB. SIMP. 4X2 SPORT 2P	2008/2009	
	RANGER 2.3 XLT CAB. DUPLA 4X2 4P	2008/2012	
	RANGER 2.3 XLT CAB. DUP. 4X2 LIMITED 4P	2010/2012	
	RANGER 2.5 CAB. DUPLA 4X2 4P DIESEL	2000	
	RANGER 2.5 CAB. DUPLA 4X2 4P GASOLINA	2000	
	RANGER 2.5 CAB. DUPLA 4X4 4P	2000	
	RANGER 2.5 CAB. REG. 4X2 2P DIESEL	2000	
	RANGER 2.5 CAB. REG. 4X2 2P GASOLINA	2000	
	RANGER 2.5 CAB. REGULAR 4X4 2P	2000	
	RANGER 2.5 STD 6 4X2 2P	1999	
	RANGER 2.5 STD 7 4X4 2P	1999	
	RANGER 2.5 SUPER CAB. 4X2 4P DIESEL	2000	
	RANGER 2.5 SUPER CAB. 4X2 4P GASOLINA	2000	
	RANGER 2.5 SUPER CAB. 4X4 4P	2000	
	RANGER 2.5 XL CAB. DUPLA 4X2 4P DIESEL	2001	
	RANGER 2.5 XL CAB. DUPLA 4X2 4P GAS.	2001	
	RANGER 2.5 XL CAB. DUPLA 4X4 4P	2001	
	RANGER 2.5 XL CAB. REG. 4X2 2P DIESEL	2001	
	RANGER 2.5 XL CAB. REG. 4X2 2P GAS.	2001	
	RANGER 2.5 XL CAB. REGULAR 4X4 2P	2001	
	RANGER 2.5 XL SUPER CAB. 4X2 4P DIESEL	2001	
	RANGER 2.5 XL SUPER CAB. 4X2 4P GAS.	2001	
	RANGER 2.5 XL SUPER CAB. 4X4 4P	2001	
	RANGER 2.5 XLT 7 4X4 2P	1999	
	RANGER 2.5 XLT CAB. DUPLA 4X2 4P	2000/2001	
	RANGER 2.5 XLT CAB. DUPLA 4X4 4P	2000/2001	
	RANGER 2.5 XLT CAB. REGULAR 4X2 2P	2000	
	RANGER 2.5 XLT CAB. REGULAR 4X4 2P	2000	
	RANGER 2.5 XLT SUPER CAB. 4X2 4P	2000	
	RANGER 2.5 XLT SUPER CAB. 4X4 4P	2000/2001	
	RANGER 2.8 CENTENNIAL CAB. DUPLA 4X4 4P	2004	
	RANGER 2.8 LIMITED TWO TONE CAB. DUP. 4P	2004/2005	
	RANGER 2.8 STORM CAB. DUPLA 4X4 4P	2004	
	RANGER 2.8 XL CAB. DUPLA 4X2 4P	2002/2004	
	RANGER 2.8 XL CAB. DUPLA 4X4 4P	2002/2004	



YN-PF0010

CONEXÃO K

MARCA	MODELO	ANO	POLEGADAS MOT. PAX.
	RANGER 2.8 XL CAB. SIMPLES 4X2 2P	2002/2004	10" 10"
	RANGER 2.8 XL CAB. DUPLA 4X4 4P	2002/2004	
	RANGER 2.8 XL CAB. SIMPLES 4X2 2P	2002/2004	
	RANGER 2.8 XL CAB. SIMPLES 4X4 2P	2002/2004	
	RANGER 2.8 XL SUPER CAB. 4X2 4P	2002/2003	
	RANGER 2.8 XL SUPER CAB. 4X4 4P	2002/2003	
	RANGER 2.8 XLS CAB. DUPLA 4X2 4P	2004/2005	
	RANGER 2.8 XLS CAB. DUPLA 4X4 4P	2004/2006	
	RANGER 2.8 XLS CAB. SIMPLES 4X2 2P	2004/2005	
	RANGER 2.8 XLS CAB. SIMPLES 4X4 2P	2004	
	RANGER 2.8 XLT CAB. DUPLA 4X2 4P	2002/2005	
	RANGER 2.8 XLT CAB. DUPLA 4X4 4P	2002/2005	
	RANGER 2.8 XLT LIMITED CAB. DUPLA 4P	2003/2005	
	RANGER 2.8 XLT SUPER CAB. 4X4 4P	2002/2003	
	RANGER 3.0 XL CAB. DUPLA 4X2 4P	2010/2012	
	RANGER 3.0 XL CAB. DUPLA 4X4 4P	2010/2012	
	RANGER 3.0 XL CAB. SIMPLES 4X2 2P	2010/2012	
	RANGER 3.0 XL CAB. SIMPLES 4X4 2P	2010/2012	
	RANGER 3.0 XLS CAB. DUPLA 4X2 4P	2005/2012	
	RANGER 3.0 XLS CAB. DUPLA 4X4 4P	2005/2012	
	RANGER 3.0 XLS CAB. SIMPLES 4X2 2P	2005/2012	
	RANGER 3.0 XLS STORM CAB. DUPLA 4X4 4P	2009	
	RANGER 3.0 XLT CAB. DUPLA 4X2 4P	2005/2012	
	RANGER 3.0 XLT CAB. DUPLA 4X4 4P	2005/2012	
	RANGER 3.0 XLT LIMITED CAB. DUPLA 4X4 4P	2005/2012	
	RANGER 3.0 XLT LIMITED TWOTONE CAB. DUP. 4X4 4P	2005/2009	
	RANGER 4.0 XL CAB. SIMPLES 4X2 2P	2000	
	RANGER 4.0 XL CAB. SIMPLES 4X2 2P	2002/2003	
	RANGER 4.0 XL CAB. SIMPLES 4X2 2P 162HP	2001	
	RANGER 4.0 XL CAB. SIMPLES 4X2 2P 210HP	2001	
	RANGER 4.0 XLT 6 4X2 2P	1999	
	RANGER 4.0 XLT 7 4X4 2P	1999	
	RANGER 4.0 XLT CAB. DUPLA 4X4 4P	2000	
	RANGER 4.0 XLT CAB. DUPLA 4X4 4P	2002/2003	
	RANGER 4.0 XLT CAB. DUPLA 4X4 4P 162HP	2001	
	RANGER 4.0 XLT CAB. DUPLA 4X4 4P 210HP	2001	
	RANGER 4.0 XLT CAB. REGULAR 4X4 2P	2000	
	RANGER 4.0 XLT SUPER CAB. 4X2 4P	2000	
	RANGER 4.0 XLT SUPER CAB. 4X4 4P	2000	
	RANGER 4.0 XLT SUPER CAB. 4X4 4P	2002/2003	
RANGER 4.0 XLT SUPER CAB. 4X4 4P 162HP	2001		
RANGER 4.0 XLT SUPER CAB. 4X4 4P 210HP	2001		
	H100 2.6 12L 4P	2002	
	H100 2.6 GL 4P	2000/2001	
	H100 2.6 GL C/CARROCERIA 2P	2002	
	H100 2.6 GL S/CARROCERIA 2P	2002	
	H100 2.6 GLS 4P	2000/2001	
	H100 2.6 GRAND SALOON 4P	2000	
	H100 2.6 SUPER 16L 4P	2002	
	H100 2.6 TOP 4P	2001	
	CHEROKEE 4.0 SPORT 5P	1998	
CHEROKEE 4.0 SPORT AUT. 5P	1998		
	BESTA 2.7 GS 4P	1998	
	320 1.3 16V DX 5P	2011	
	320 1.3 16V LX 5P	2011/2012	
	B2500 2.5 CD 4P	1999	
	B2500 2.5 CS 4X2 C/VENTILADOR 2P	1999	
	B2500 2.5 CS 4X2 S/VENTILADOR 2P	1999	
	CLUBMAN 1.6 S AUT. 5P	2011	
	CLUBMAN 1.6 S HAMPTON AUT. 5P	2012	
	COOPER 1.5 AUT. 2P	2019	
	COOPER 1.5 AUT. 3P	2015/2017	
	COOPER 1.5 AUT. 5P	2015/2020	
	COOPER 1.5 AUT. 5P 7 MARCHAS	2021	



YN-PF0010

CONEXÃO K

MARCA	MODELO	ANO	POLEGADAS MOT. PAX.
	COOPER 1.5 EXCLUSIVE AUT. 3P	2018/2020	10" 10"
	COOPER 1.5 TOP AUT. 3P	2018/2020	
	COOPER 1.5 TOP AUT. 3P 7 MARCHAS	2021	
	COOPER 1.5 TOP AUT. 5P	2018	
	COOPER 1.6 AUT. 2P	2011/2012	
	COOPER 1.6 CHILLI AUT. 3P	2011/2012	
	COOPER 1.6 JOHN COOPER WORKS	2014	
	COOPER 1.6 JOHN COOPER WORKS 3P	2011/2013	
	COOPER 1.6 PEPPER AUT. 3P	2011/2012	
	COOPER 1.6 S AUT. 2P	2011/2012	
	COOPER 1.6 S AUT. 2P	2015	
	COOPER 1.6 S HIGHGATE AUT. 2P	2014	
	COOPER 1.6 S TOP AUT. 2P	2014	
	COOPER 1.6 SALT 3P	2011/2012	
	COOPER 2.0 JOHN COOPER WORKS 3P	2016/2020	
	COOPER 2.0 JOHN COOPER WORKS 3P 8M	2021	
	COOPER 2.0 JOHN COOPER WORKS AUT. 2P	2019/2020	
	COOPER 2.0 JOHN COOPER WORKS AUT. 2P 8M	2021	
	COOPER 2.0 JOHN COOPER WORKS GP 3P 8M	2020	
	COOPER 2.0 S AUT. (NL) 2P	2019/2020	
COOPER 2.0 S AUT. (NL) 2P 7 MARCHAS	2021		
COOPER 2.0 S AUT. 2P	2016/2018		
COOPER 2.0 SIDEWALK AUT. 2P	2021		
COOPER COUPÉ 1.6 AUT. 2P	2012		
ONE 1.6 3P	2011/2012		
ONE 1.6 AUT. 3P	2012		
	L300 2.5 STD 5P	1999	
	EXPRESS 1.6 RL 4P	1998	
	IGNIS 1.3 16V GL 4X2 5P	2003	
	IGNIS 1.3 16V GL 4X2 AUT. 5P	2003	
	IGNIS 1.3 16V WRS 4X4 5P	2003	



YN-PF0013

CONEXÃO K

MARCA	MODELO	ANO	POLEGADAS MOT. PAX.
	TOWNER	1993/1999	13" 13"
	MOTONIVELADORA	1950/2024	
	120H, 120K, 12K, 140K (PASSAGEIRO)		
	CELER	2013/2024	
	QQ	2011/2015	
	BLAZER	1996/2012	
	BONANZA	1989/1994	
	CARAVAN	1975/1992	
	CORSA 4P	2001/2003	
	CORSA WAGON	1997/2002	
	IPANEMA	1990/1998	
	OMEGA SUPREMA	1992/1998	
VERANEIO	1989/1995		
	TERIOS	1997/1999	
	ELBA	1986/1994	
	UNO	1984/1994	
	MONDEO SW	1993/2000	



YN-PF0013

CONEXÃO K

MARCA	MODELO	ANO	POLEGADAS MOT. PAX.
	CRV	1995/2001	13" 13"
	SANTA FÉ	2001/2006	
	CHEROKEE	1997/2001	
	WRANGLER	1996/2006	
	LAIKA	1990/1995	
	NIVA	1990/1995	
	CAMRY WAGON	1992/1993	
	GOLF G3	1993/1998	
	GOLF G4	1999/2006	
	POLO HATCH	2002/2008	
	VARIANT G2	1977/1983	
	111	1976/1981	



YN-PF0016

CONEXÃO K

MARCA	MODELO	ANO	POLEGADAS MOT. PAX.
	147	2001/2005	16" 16"
	SPIDER	1984/1993	
	GALOPER	1998/1999	
	80 AVANT	1991/1996	
	AVANT RS2	1994/1996	
	FACE	2010/2024	
	QQ	2011/2015	
	S18	2010/2024	
	BONANZA	1989/1994	
	CAPTIVA	2008/2015	
	CHEVETTE	1973/1993	
	COBALT	2012/2024	
	CORSA	1994/2002	
	CORSA PICKUP	1986/1998	
	KADETT	1989/1998	
	MARAJÓ	1981/1989	
VERANEIO	1989/1995		
CHEVY 500	1983/1995		
	AX	1986/1998	
	BERLINGO	1996/2007	
	XM	1994/2000	
	XANTIA	1993/2003	
	TICO	1992/2000	
	CUORE	1993/1999	
	IDEA ADVENTURE	2006/2010	
	IDEA	2006/2010	
	MOBI	2016/2024	
	PUNTO IMPORTADO	1993/1999	
	UNO VIVACE	2011/2015	
	FIORINO	2014/2024	



YN-PF0016

CONEXÃO K

MARCA	MODELO	ANO	POLEGADAS MOT. PAX.
	BELINA	1969/1977	16" 16"
	BELINA G2	1978/1991	
	DEL REY	1981/1991	
	DEL REY BELINA/SCALA	1981/1991	
	ECOSPORT	2017/2024	
	GALAXIE	1967/1989	
	LTD	1967/1989	
	LANDAU	1967/1983	
	MAVERICK	1973/1979	
	RANGER	2013/2015	
PAMPA	1982/1997		
	CRV	2013/2024	
	FIT	2003/2008	
	ODYSSEY	1995/1998	
	ATOS	1998/2024	
	CRETA	2021/2024	
	HB20, HB20S, HB20X	2012/2024	
	TERRACAN	2001/2007	
	TUCSON	2004/2024	
IX35	2010/2024		
	J3	1998/2024	
	J3 TURIN	2021/2024	
	CARENS K2400	1995/1999	
	CERATO	2004/2009	
	PICANTO	2006/2011	
	SPORTAGE	1994/2010	
	BESTA	1993/1997	
	LS 400	1999/2000	
	LS 430	2001/2006	
	620	2010/2024	
	626, 626 WAGON	1992/1997	
	MPV MINI-VAN	1994/1999	
	MPV MINI-VAN G2	2000/2006	
	PREMACY	1999/2024	
	PICK-UP B2500	1990/1997	
	200T, 300T	1976/1985	
	CLASSE G	2002/2024	
	CLASSE GLK	1996/2004	
	1113	1969/1987	
	COLT	1995/1997	
	PAJERO TR4	2002/2009	
	SPACE WAGON	1992/1998	
	MAXIMA	2001/2024	
	MURANO	2007/2011	
	TIIDA	2008/2013	
	X-TRAIL	2001/2009	
	FRONTIER	2017/2024	
	106	1991/2001	
	206	2008/2013	
	206 CC	2011/2013	
	206 SW	2001/2009	
	207	2008/2024	
	207 SW	2008/2014	
	207 SEDAN	2008/2024	
	306	1993/2001	
	HOGGAR	2010/2014	
	PARTNER	2010/2024	
PICK-UP 504 GD, PICK-UP 504 GDR	1992/1999		
	GTC, GTE, GTI, GTS	1976/1987	



YN-PF0016

CONEXÃO K

MARCA	MODELO	ANO	POLEGADAS MOT. PAX.
	IMPREZA	1993/2000	16" 16"
	IMPEZA WAGON	1993/2000	
	JIMMY	1998/2024	
	COROLLA CROSS	2022/2024	
	COROLLA FIELDER	2004/2008	
	COROLLA WAGON	1992/1996	
	PRIUS	2013/2024	
	RAV4	2006/2014	
	HILUX	1993/1997	
	HILUX SW	1997/2004	
	T4	2004/2014	
	GOL 1000	1980/1996	
	GOL SPECIAL	1998/2005	
	GOL G5	2008/2012	
	GOL G8	2018/2024	
	PARATI	1982/1996	
	PASSAT	1974/1989	
	PASSAT IV VARIANT	1993/1993	
	VOYAGE	2008/2024	
	KOMBI	1975/2013	
	KOMBI FURGÃO	1975/2012	
	KOMBI PICK-UP	1975/2012	
	SAVEIRO	1982/1997	
	SAVEIRO G5	2010/2012	
		V40	1996/2004
V70		1997/2000	
CAMINHÕES VOLVO VM NL10, NL12, N10, N12		1989/1999 1981/1999	
	TOPIC	1993/2000	
	TOWNER	1993/1999	
	KORANDO	2011/2024	
	MOTONIVELADORA 12M	1950/2024	
	TRATOR DE ESTEIRA D6R/D6T/DSL	1950/2024	
	CLIO	1994/1999	
	FLUENCE	2015/2024	
	MÉGANE SCÉNIC	1997/2010	
	SCENIC	1997/2004	
	SCANIA 113	1969/1987	



YN-PF0019

CONEXÃO K

MARCA	MODELO	ANO	POLEGADAS MOT. PAX.
	DUCATO	2011/2017	19" 19"
	DUNA	1990/1996	
	ELBA	1986/1996	
	FIORINO	1987/2013	
	UNO MILLE	1984/2013	
	PRÊMIO	1985/1996	
	COURIER	1997/2013	
	FIESTA HATCH	1996/2007	
	FOCUS SEDAN	2000/2010	
	KA	1998/2007	
	KA G2	2008/2010	

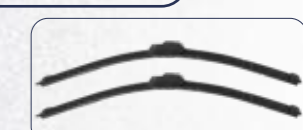

YN-PF0019

CONEXÃO K

MARCA	MODELO	ANO	POLEGADAS MOT. PAX.		
HONDA	ACCORD CIVIC CRV	1990/2000 2001/2006 2000/2001	19" 19"		
	JAGUAR	X TYPE		2001/2009	
		Jeep		CHEROKEE LIBERTY	2002/2016 2004
KIA	CLARUS CLARUS WAGON SEPHIA SHUMA SHUMA G2			1996/1997 1998/1999 1993/1997 1996/2000 2001	
	Mazda	WAGON 626		1998/2000	
		MITSUBISHI MOTORS		AIRTREK COLT LANCER PAJERO CLASSIC PAJERO TR4	2003/2008 1995/1997 1997/2002 1991/2000 2002/2015
	NISSAN			KING CAB PRIMERA SENTRA XTERRA	1993/1995 1995 1995/1997 2003/2008
SEAT				CORDOBA IBIZA	2000/2002 2000/2003
				SUBARU	FORESTER LEGACY GRAND VITARA
TOYOTA	CAMRY WAGON CAMRY HILUX SW4 SW4	1991/1993 1991/2000 2006/2016 2005/2015			
	Volkswagen	BORA GOL G3 GOL G2 SPECIAL GOL G4 GOLF CABRIO G3 GOLF G4 PARATI PARATI G3 PARATI POLO CLASSIC POLO SEDAN SAVEIRO G3 SAVEIRO G4			1999/2011 1999/2000 2001/2004 2005/2013 1993/1998 1999/2008 1999/2002 2003/2004 2005/2012 2001 2002/2009 2000/2008 2009/2010
		Volvo	S40 V40	1996/2003 1996/2004	



YN-PF0020

CONEXÃO K

MARCA	MODELO	ANO	POLEGADAS MOT. PAX.		
CATERPILLAR	COMPAC. VIBRATÓRIO DE SOLO CP54B PÁ CARREGADEIRA 924G ROLETE PNEUMÁTICO CW34 ROLETE VIBRATÓRIO EM TANDEM CB7	1950/2024 1950/2024 1950/2024 1950/2024	20" 20"		
	FENDT	TRATOR 942 VARIO TRATOR 1046 VARIO TRATOR 939 VARIO		1950/2024 1950/2024 1950/2024	
		JOHN DEERE		ESCAVADEIRA LC160G, LC240G	1950/2024
				KUHN	PULVERIZADOR BOXER 2000
MASSEY FERUGER	PULVERIZADOR 9030 TRATOR 4797, 7370	1950/2024 1950/2024			
	MONTANA	BOXER		1950/2024	
NEW HOLLAND		PULVERIZADOR SP2500 TRATOR T6		1950/2024 1950/2024	
	Stara	TRATOR ST MAX 180		1950/2024	
SEM		PÁ CARREGADEIRA 616B		1950/2024	
	Tractor	155		1992/1997	
Audi		80		1991/1994	
	BMW	M ROADSTER M3 (E36) SÉRIE 3 (E36) SÉRIE 3 CABRIO (E36) SÉRIE 3 COMPACT SÉRIE 3 COUPE SÉRIE 3 TOURING X3 X5 X6 Z4 Z4 (E85, E89)	1999/2003 1994/1998 1990/1998 1993/1999 1994/1996 1992/1999 1995/1999 2004/2009 2000/2024 2016/2024 2003/2024 2003/2024		
CHEVROLET		ASTRA HATCH BLAZER CORSA HATCH CORSA SEDAN SPACE VAN MONTANA S10	1999/2011 1996/2024 2001/2012 2001/2011 1994/1998 2003/2010 1995/2011		
		CHRYSLER	NEON PT CRUISER	1994/1999 2000/2011	
			CITROËN	XSARA XSARA BREAK	1997/2005 1997/2005
		DAEWOO		NUBIRA NUBIRA WAGON	1997/2003 1997/2003



YN-PF0020

CONEXÃO K

MARCA	MODELO	ANO	POLEGADAS MOT. PAX.
AGRALE	TRATOR 575	1950/2024	20" 20"
	CASE	TRATOR MXM 165 TRATOR 80 TRATOR 185	



YN-PF0020

CONEXÃO K

MARCA	MODELO	ANO
	F355 F355 BERLINETA F355 SPIDER	1994/1998 1994/1998 1995/1998
	TEMPRA TEMPRA SW TIPO	1992/1999 1995/1997 1994/1997
	ESCORT XR3 ESCORT ESCORT SW ESCORT SEDAN MONDEO MONDEO SW MUSTANG TAUTUS VERONA	1993/1996 1997/2002 1997/2002 1997/2003 1997/2002 2001/2007 1994/2004 1992/1996 1994/1996
HONDA	CR-VG2 CIVIC LEGEND PRELUDE	2002/2007 1991/2000 1991/2004 1992/1997
	ACCENT ATOS ATOS PRIME AZERA ELANTRA ELANTRA SW H1 SONATA TERRACAN HR	1994/2024 1998/2024 1998/2003 2007/2011 1990/1998 1996/1998 2008/2024 1993/2010 2001/2007
Jeep	COMPASS GRAND CHEROKEE	2012/2024 1993/2010
	CERATO CERATO KOUP MOHAVE SOUL SPORTAGE BESTA BONGO K2700	2010/2024 2010/2013 2009/2024 2009/2024 1994/2004 1998/2024 1998/2004
	FREELANDER	1998/2006
	MX-3 MX-3 PROTEGÉ	1991/1993 1994/1998 1991/2000
	200T 207D 300-TE TURBO DIESEL 410 (T1) MB 180D	1976/1985 1977/1995 1976/1985 1988/1996 1988/1996
	ASX AIRTREK COLT ECLIPSE ECLIPSE LANCER OUTLANDER PAJERO FULL PAJERO SPORT L200 SAVANA L200 SPORT L200 OUTDOOR	2011/2024 2003/2008 1992/1995 1992/1995 2019/2024 1993/1995 2007/2013 2006/2013 1999/2011 2004/2024 2004/2012 2004/2012
	350Z	2002/2009

POLEGADAS
MOT. PAX.
20" 20"



YN-PF0020

CONEXÃO K

MARCA	MODELO	ANO
	19 19 SEDAN 21 21 NEVADA CLIO CLIO G2 CLIO SEDAN DUSTER LOGAN MEGANE SANDERO KANGOO ORCH TRAFIC	1989/1997 1989/1997 1989/1994 1989/1994 1994/1999 1999/2016 2000/2009 2012/2019 2007/2013 1997/2014 2008/2014 2000/2024 2015/2024 1994/2002
		
	CORDOBA IBIZA INCA	1993/1999 1994/1999 1999/2002
	MUSSO REXTON II	1999/2005 2002/2005
	IMPREZA IMPREZA WAGON	1993/2000 1993/2000
	BALENO BALENO WAGON GRAND VITARA SWIFT HATCH WAGON R+	1995/2002 1995/2002 2008/2024
	COROLLA COROLLA WAGON CORONA PASEO RAV4	1992/2001 1992/2001 1992/2000 1996/1999 1994/2000
	GOL G2 LOGUS PARATI PASSAT G4 PASSAT G5 PASSAT VARIANT G5 POINTER QUANTUM SANTANA SAVEIRO G2 VAN	1995/2001 1993/1997 1996/1999 1993/2001 2001/2002 1998/2002 1994/1996 1998/2002 1998/2006 1997/1999 1997/2002
	460 850 850 SPORTS WAGON 960 C70 S70 V70	1990/1996 1991/1996 1991/1996 1990/1996 1997/2002 1997/2000 1997/2000
	GRAN MOVE TERIOS	1997/1999 1997/1999
	DAKOTA RAM PICKUP	1995/2003 1993/2001
	106	1991/2004

POLEGADAS
MOT. PAX.
20" 20"



YN-PF0022

CONEXÃO K

MARCA	MODELO	ANO	POLEGADAS MOT. PAX.
	147	2001/2005	22" 22"
	100 100 AVANT A6 A6 AVANT A8 S4 S6	1990/1994	
	FACE QQ S18	2010/2024 2011/2015 2010/2024	
	SPIN VECTRA	2013/2024 2006/2008	
	300C 300C TOURING 300M SEBRING STRATUS	2004/2011 2004/2011 1998/2004 2001/2006 1995/2001	
	AX BERLINGO XM XM BREAK ZX	1986/1998 1996/2024 1989/2000 1989/2000 1991/1997	
	NUBIRA WAGON	2003/2005	
	DOBLO STILO	2001/2024 2002/2011	
	ECOSPORT EXPLORER FIESTA HATCH FIESTA HATCH G2 FIESTA SEDAN FIESTA SEDAN G2 TERRITORY	2005/2012 2003/2005 2000/2010 2005/2011 2000/2010 2005/2011 2021/2024	
	ODYSSEY	1995/1998	
	COUPE FX	1996/2009	
	J3 J3 TURIN J5	1996/2009	
	CARNIVAL G3 MAGENTIS PICANTO	2007/2010 2001/2005 2006/2024	
	DISCOVERY III DISCOVERY IV RANGE ROVER G2 RANGE ROVER III	2003/2004 2005/2024 1994/2002 2003/2024	
	ES 300	1997/2005	
	GALANT PAJERO DAKAR SPACE WAGON	1993/2004 2010/2024 1992/1998	



YN-PF0024

CONEXÃO K

MARCA	MODELO	ANO	POLEGADAS MOT. PAX.
	X5 X6	2000/2024 2016/2024	24" 24"
	TIGGO	2009/2024	
	CAPTIVA CRUZE CRUZE SPORT MERIVA ZAFIRA	2008/2015 2011/2015 2011/2024 2002/2012 2000/2012	
	C3 C3 XTT C5 C5 BREAK XANTIA XANTIA BREAK	2002/2012 2002/2012 2001/2003 2001/2003 1993/2003 1995/2003	
	JOURNEY RAM 1500 RAM PICKUP	2008/2024 2022/2024 2005/2011	
	FREEMONT IDEA IDEA ADVENTURE MOBI UNO UNO VIVACE FIORINO	2011/2024 2006/2010 2006/2010 2016/2024 2011/2014 2011/2015 2014/2024	
	ECOSPORT FIESTA SEDAN G2 FIESTA HATCH G2 FUSION RANGER	2003/2004 2002/2004 2002/2004 2006/2012 2013/2015	
	ACCORD FIT	2003/2004 2002/2004	
	AZERA CRETA H1 HB20, HB20S, HB20X SANTA FÉ SONATA TUCSON I30 I30CW IX35	2007/2011 2021/2024 2008/2024 2012/2024 2007/2012 2005/2010 2004/2024 2008/2012 2008/2024 2010/2024	
	J2 J6	2012/2024 2010/2024	
	COMPASS	2017/2024	
	CARENS CARENS G2 CARENS G3 CARNIVAL CARNIVAL G2 CERATO CERATO KOUPE MAGENTIS OPIRUS OPTIMA SORENTO SOUL SPORTAGE G2 SPORTAGE G3	2000/2006 2003/2006 2007/2012 1999/2001 2002/2006 2004/2009 2010/2013 2006/2010 2003/2009 2012/2024 2003/2009 2009/2024 2005/2010 2011/2024	



YN-PF0024

CONEXÃO K

MARCA	MODELO	ANO	POLEGADAS MOT. PAX.
	LS 430	2003/2006	24" 24"
	520 530 SUV, X60	2010/2024 2014/2024 2010/2024	
	MPV MINI PREMACY	2000/2006 1999/2004	
	ASX ECLIPSE LANCER OUTLANDER	2011/2024 2019/2024 2003/2024 2007/2014	
	GRAND LIVINA LIVINA PATHFINDER XTRAIL FRONTIER	2010/2024 2010/2024 2005/2009 2001/2012 2007/2024	
	406 BREAK	1998/2003	
	KORANDO	2011/2024	
	FORESTER IMPREZA LEGACY, L. OUTBACK, L. WAGON	2008/2024 2008/2024 2003/2009	
	CAMRY COROLLA COROLLA FIELDER RAV4 G2 RAV4 G3 YARIS	2001/2006 2002/2008 2004/2008 2000/2005 2006/2012 2018/2024	
	V70 G2 XC70, XC90	2000/2003 2002/2004	
	RETROESCAVADEIRA 580M/580N TRATOR 205	1950/2024 1950/2024	
	ESCAVADEIRA DX255LCA RETROESCAVADEIRA 416E	1950/2024 1950/2024	
	TRATOR 1046 TRATOR 739 VARIO TRATOR 942 VARIO	1950/2024 1950/2024 1950/2024	
	RETROESCAVADEIRA 310K TRATOR 8270R TRATOR 7225J	1950/2024 1950/2024 1950/2024	
	AMAROK	2010/2013	



YN-PF0024

CONEXÃO K

MARCA	MODELO	ANO	POLEGADAS MOT. PAX.
	X5 X6	2000/2024 2016/2024	24" 24"
	TIGGO	2009/2024	
	CAPTIVA CRUZE CRUZE SPORT MERIVA ZAFIRA	2008/2015 2011/2015 2011/2024 2002/2012 2000/2012	
	C3 C3 XTT C5 C5 BREAK XANTIA XANTIA BREAK	2002/2012 2002/2012 2001/2003 2001/2003 1993/2003 1995/2003	
	JOURNEY RAM 1500 RAM PICKUP	2008/2024 2022/2024 2005/2011	
	FREEMONT IDEA IDEA ADVENTURE MOBI UNO UNO VIVACE FIORINO	2011/2024 2006/2010 2006/2010 2016/2024 2011/2014 2011/2015 2014/2024	
	ECOSPORT FIESTA SEDAN G2 FIESTA HATCH G2 FUSION RANGER	2003/2004 2002/2004 2002/2004 2006/2012 2013/2015	
HONDA	ACCORD FIT	2003/2004 2002/2004	
	AZERA CRETA H1 HB20, HB20S, HB20X SANTA FÉ SONATA TUCSON I30 I30CW IX35	2007/2011 2021/2024 2008/2024 2012/2024 2007/2012 2005/2010 2004/2024 2008/2012 2008/2024 2010/2024	
	J2 J6	2012/2024 2010/2024	
Jeep	COMPASS	2017/2024	
	CARENS CARENS G2 CARENS G3 CARNIVAL CARNIVAL G2 CERATO CERATO KOUPE MAGENTIS OPIRUS OPTIMA SORENTO SOUL SPORTAGE G2 SPORTAGE G3	2000/2006 2003/2006 2007/2012 1999/2001 2002/2006 2004/2009 2010/2013 2006/2010 2003/2009 2012/2024 2003/2009 2009/2024 2005/2010 2011/2024	



YN-PF1523

CONEXÃO K

MARCA	MODELO	ANO	POLEGADAS MOT. PAX.
	TRATOR 575	1950/2024	20" 20"

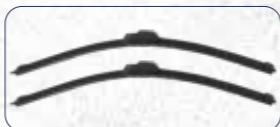

YN-PF0024

CONEXÃO K

MARCA	MODELO	ANO	POLEGADAS MOT. PAK.
	LS 430	2003/2006	24" 24"
	520 530 SUV, X60	2010/2024 2014/2024 2010/2024	
	MPV MINI PREMACY	2000/2006 1999/2004	
	ASX ECLIPSE LANCER OUTLANDER	2011/2024 2019/2024 2003/2024 2007/2014	
	GRAND LIVINA LIVINA PATHFINDER XTRAIL FRONTIER	2010/2024 2010/2024 2005/2009 2001/2012 2007/2024	
	406 BREAK	1998/2003	
	KORANDO	2011/2024	
	FORESTER IMPREZA LEGACY, L. OUTBACK, L. WAGON	2008/2024 2008/2024 2003/2009	
	CAMRY COROLLA COROLLA FIELDER RAV4 G2 RAV4 G3 YARIS	2001/2006 2002/2008 2004/2008 2000/2005 2006/2012 2018/2024	
	V70 G2 XC70, XC90	2000/2003 2002/2004	
	RETROESCAVADEIRA 580M/580N TRATOR 205	1950/2024 1950/2024	
	ESCAVADEIRA DX255LCA RETROESCAVADEIRA 416E	1950/2024 1950/2024	
	TRATOR 1046 TRATOR 739 VARIO TRATOR 942 VARIO	1950/2024 1950/2024 1950/2024	
	RETROESCAVADEIRA 310K TRATOR 8270R TRATOR 7225J	1950/2024 1950/2024 1950/2024	
	AMAROK	2010/2013	



YN-PF1523

CONEXÃO K

MARCA	MODELO	ANO	POLEGADAS MOT. PAK.
	CR-V 1.5 TOURING TURBO AWD AUT 5P	2018	23" 15"
	CR-V 2.0 EX 4X4 AUT.	2021	
	CR-V 2.0 EXL 4X2 FLEX AUT. 5P	2007	
	CR-V 2.0 EXL 4X4 AUT. 5P	2013/2014	
	CR-V 2.0 EXL 4X4 FLEX AUT. 5P	2008/2012	
	CR-V 2.0 LX 4X2 5P	2013/2016	
	CR-V 2.0 LX 4X2 AUT. 5P	2012	
	CR-V 2.0 LX 4X2 FLEX AUT. 5P	2008/2012	
	HR-V 1.8 EX FLEX AUT 5P	2013/2015	
	HR-V 1.8 EXL FLEX AUT 5P	2016/2018	
	HR-V 1.8 LX FLEX 5P	2016/2018	
	HR-V 1.8 LX FLEX AUT. 5P	2016/2018	
	HR-V 1.8 TOURING FLEX AUT.	2017/2018	



YN-PF1523

CONEXÃO K

MARCA	MODELO	ANO	POLEGADAS MOT. PAK.	
	LS 1.0	2001/2002	23" 15"	
	MAXIMA 3.0 30 GV 4P	2001		
	MAXIMA 3.0 30 GV LIMITED 4P	2001/2002		
	MURANO 3.5 SE 5P	2007/2009		
	SENTRA 2.0 3 AMÉRICAS AUT. 4P	2008		
	SENTRA 2.0 4P	2008/2009		
	SENTRA 2.0 AUT. 4P	2008/2009		
	SENTRA 2.0 FLEX 4P	2009/2013		
	SENTRA 2.0 FLEX AUT. 4P	2011/2013		
	SENTRA 2.0 S 4P	2007/2009		
	SENTRA 2.0 S AUT. 4P	2008/2009		
	SENTRA 2.0 S FLEX 4P	2009/2010		
	SENTRA 2.0 S FLEX AUT. 4P	2009/2013		
	SENTRA 2.0 SL AUT. 4P	2007/2009		
	SENTRA 2.0 SL FLEX AUT. 4P	2009/2013		
	SENTRA 2.0 SPE. ED. FLEX AUT. 4P	2013		
	SENTRA 2.0 SR FLEX 4P	2012		
	SENTRA 2.0 SR FLEX AUT. 4P	2012		
	SENTRA 2.0 UNIQUE FLEX AUT. 4P	2012		
	TIIDA 1.8 S FLEX 5P	2009/2013		
	TIIDA 1.8 S FLEX AUT. 5P	2009/2010		
	TIIDA 1.8 SL FLEX 5P	2009/2013		
	TIIDA 1.8 SL FLEX AUT. 5P	2009/2013		
		206 1.0 16V QUIKSILVER 3P	2002/2004	
		206 1.0 16V SELECTION 3P	2001/2004	
		206 1.0 16V SELECTION 5P	2001/2004	
		206 1.0 16V SELECTION PACK 3P	2001/2004	
		206 1.0 16V SELECTION PACK 5P	2001/2004	
		206 1.0 16V SENSATION 3P	2004/2006	
		206 1.0 16V SENSATION 5P	2004/2006	
		206 1.0 16V SOLEIL 3P 2001/2004	2001/2004	
		206 1.0 16V SOLEIL 5P 2001/2004	2001/2004	
206 1.0 16V TECHNO 5P 2003/2004		2003/2004		
206 1.4 FELINE 5P 2004/2006		2004/2006		
206 1.4 FELINE FLEX 5P 2006/2008		2006/2008		
206 1.4 HOLIDAY 3P 2006		2006		
206 1.4 HOLIDAY 5P 2006		2006		
206 1.4 MOONLIGHT FLEX 3P 2008		2008		
206 1.4 MOONLIGHT FLEX 5P 2008		2008		
206 1.4 PRESENCE 3P 2004/2006		2004/2006		
206 1.4 PRESENCE 5P 2004/2006		2004/2006		
206 1.4 PRESENCE FLEX 3P 2006/2008		2006/2008		
206 1.4 PRESENCE FLEX 5P 2006/2008		2006/2008		
206 1.4 SENSATION FLEX 3P 2006/2009		2006/2009		
206 1.4 SENSATION FLEX 5P 2006/2009		2006/2009		
206 1.6 16V ALLURE FLEX 3P 2008		2008		
206 1.6 16V ALLURE FLEX 5P 2008		2008		
206 1.6 16V FELINE 5P 2004/2005	2004/2005			
206 1.6 16V FELINE FLEX 5P	2005/2007			
206 1.6 16V FELINE FLEX AUT. 5P	2008			



YN-PF1523

CONEXÃO K

MARCA	MODELO	ANO	POLEGADAS MOT. PAK.
	ACCORD 2.0 EX 4P	2010/2012	23" 15"
	ACCORD 2.0 EX TURBO	2019	
	ACCORD 10 MARCHAS EX TURBO 4P	2020	
	ACCORD 2.0 LX 4P	2006/2009	
	ACCORD 2.4 EX 4P	2003/2005	
	ACCORD 2.4 LX	2013/2014	
	ACCORD 3.0 V6 EX 4P	2005	
	ACCOR 3.5 V6 EX 4P	2004/2007	
	CR-V 1.5 TOURING TURBO AWD AUT 5P	2008/2017	



YN-PF1523

CONEXÃO K

MARCA	MODELO	ANO	POLEGADAS MOT. PAX.	
PEUGEOT	206 1.6 16V HOLIDAY FLEX 3P	2006	23" 15"	
	206 1.6 16V HOLIDAY FLEX 5P	2006		
	206 1.6 16V PASSION 5P	2001/2004		
	206 1.6 16V PRESENCE 5P	2004/2005		
	206 1.6 16V PRESENCE FLEX 5P	2005/2007		
	206 1.6 16V QUIKSILVER 3P	2002/2004		
	206 1.6 16V RALLYE 3P	2001/2005		
	206 1.6 16V RALLYE FLEX 3P	2005		
	206 1.6 16V SELEC. PACK 3P	2003/2004		
	206 1.6 16V SELEC. PACK 5P	2003/2004		
	206 1.6 16V SOLEIL 3P	2001/2004		
	206 1.6 16V SOLEIL 5P	2001/2004		
	206 1.6 16V TECHNO 5P	2003/2004		
	206 1.6 PASSION 5P	1999/2000		
	206 1.6 RALLYE 3P	1999/2000		
	206 1.6 SOLEIL 3P	1999/2000		
	206 1.6 SOLEIL 5P	1999/2000		
	207 1.4 ACTIVE FLEX 4P	2014/2015		
	207 1.4 ACTIVE FLEX 5P	2014/2015		
	207 1.4 ACT. IN CONCERT FLEX 4P	2014/2015		
	207 1.4 ALLURE FLEX 4P	2014		
	207 1.4 BLUE LION FLEX 5P	2013		
	207 1.4 QUIKSILVER FLEX 3P	2010/2011		
	207 1.4 QUIKSILVER FLEX 5P	2010/2011		
	207 1.4 X-LINE FLEX 3P	2010/2011		
	207 1.4 X-LINE FLEX 5P	2010/2011		
	207 1.4 XR 10 ANOS FLEX 3P	2011		
	207 1.4 XR 10 ANOS FLEX 5P	2011		
	207 1.4 XR FLEX 3P	2009/2013		
	207 1.4 XR FLEX 5P	2009/2013		
	207 1.4 XR SPORT 10 ANOS FLEX 5P	2011		
	207 1.4 XR SPORT FLEX 3P	2009		
	207 1.4 XR SPORT FLEX 5P	2009/2013		
	207 1.6 16V PAS. XS PACK FLEX AUT. 4P	2009		
	207 1.6 16V QUIKSILVER FLEX 5P	2012/2013		
	207 1.6 16V XS FLEX 3P	2009		
	207 1.6 16V XS FLEX 5P	2009/2012		
	207 1.6 16V XS FLEX AUT. 5P	2009/2013		
	207 1.6 16V XS PACK FLEX AUT. 5P	2009		
	NISSAN	MAXIMA 3.0 30 GV 4P		2001
		MAXIMA 3.0 30 GV LIMITED 4P		2001/2002
		MURANO 3.5 SE 5P		2007/2009
		SENTRA 2.0 3 AMÉRICAS AUT. 4P		2008
		SENTRA 2.0 4P		2008/2009
		SENTRA 2.0 AUT. 4P		2008/2009
		SENTRA 2.0 FLEX 4P		2009/2013
		SENTRA 2.0 FLEX AUT. 4P		2011/2013
		SENTRA 2.0 S 4P		2007/2009
		SENTRA 2.0 S AUT. 4P		2008/2009
		SENTRA 2.0 S FLEX 4P		2009/2010
		SENTRA 2.0 S FLEX AUT. 4P		2009/2013
		SENTRA 2.0 SL AUT. 4P		2007/2009
		SENTRA 2.0 SL FLEX AUT. 4P		2009/2013
	SENTRA 2.0 SPE. ED. FLEX AUT. 4P	2013		
	SENTRA 2.0 SR FLEX 4P	2012		
	SENTRA 2.0 SR FLEX AUT. 4P	2012		
SENTRA 2.0 UNIQUE FLEX AUT. 4P	2012			
TIIDA 1.8 S FLEX 5P	2009/2013			
TIIDA 1.8 S FLEX AUT. 5P	2009/2010			
TIIDA 1.8 SL FLEX 5P	2009/2013			
TIIDA 1.8 SL FLEX AUT. 5P	2009/2013			
SUBARU	FORESTER 2.0 L AWD AUT. 5P	2017/2018		
	FORESTER 2.0 S AWD AUT. (EYESIGHT) 5P	2019/2020		
	FORESTER 2.0 S AWD AUT. (EYESIGHT) 5P ELÉT.	2021		
	FORESTER 2.0 S AWD AUT. 5P	2019/2020		
	FORESTER 2.0 S AWD AUT. 5P ELÉTRICA	2021		
	FORESTER 2.0 SPORT AWD AUT. 5P	2016/2018		
	FORESTER 2.0 XT TURBO AWD AUT. 5P	2015/2018		
	OUTBACK 3.6 AWD AUT. 5P	2015/2017		
OUTBACK 3.6 R AWD AUT. (EYESIGHT) 5P	2019/2020			



YN-PF1523

CONEXÃO K

MARCA	MODELO	ANO	POLEGADAS MOT. PAX.	
SUBARU	OUTBACK 3.6 R AWD AUT. 5P	2019	23" 15"	
	OUTBACK 3.6 R AWD AUT. 5P 6 MAR.	2021		
	XV 2.0 AWD AUT. 5P	2016/2017		
	XV 2.0 L AWD GDI AUT. 5P	2018/2019		
	XV 2.0 S AWD GDI AUT. (EYESIGHT) 5P	2019		
	XV 2.0 S AWD GDI AUT. (EYESIGHT) 5P ELÉT.	2021		
	XV 2.0 S AWD GDI AUT. 5P	2018/2019		
	XV 2.0 S AWD GDI AUT. 5P ELÉTRICA	2021		
	TOYOTA	COROLLA 1.6 16V XLI AUT. 4P		2008/2010
		COROLLA 1.8 16V GLI FLEX 4P		2010/2013
COROLLA 1.8 16V GLI FLEX AUT. 4P		2010/2013		
COROLLA 1.8 16V SE-G FLEX AUT. 4P		2008/2010		
COROLLA 1.8 16V SE-G FLEX AUT. 5P		2008		
COROLLA 1.8 16V XEI FLEX 4P		2008/2010		
COROLLA 1.8 16V XEI FLEX 5P		2008		
COROLLA 1.8 16V XEI FLEX AUT. 4P		2008/2010		
COROLLA 1.8 16V XEI FLEX AUT. 5P 2008		2008		
COROLLA 1.8 16V XLI FLEX 4P 2008/2013		2008/2013		
COROLLA 1.8 16V XLI FLEX AUT. 4P		2008/2013		
COROLLA 2.0 16V ALTIS FLEX AUT. 4P		2011/2013		
COROLLA 2.0 16V XEI FLEX AUT. 4P		2011/2013		
COROLLA 2.0 16V XRS FLEX AUT. 4P		2013		
PRIUS 1.8 HYBRID 5P		2013		
PRIUS 1.8 HYBRID 5P		2015/2018		
PRIUS 1.8 HYBRID HIGH 5P HIBRIDO		2019/2020		
PRIUS 1.8 HYBRID HIGH 5P HIB. ELÉTRICA		2021		
RAV4 2.0 4X2 AUT. 5P		2013/2015		
RAV4 2.0 4X2 AUT. 5P		2018/2019		
RAV4 2.0 4X4 AUT. 5P		2013/2015		
RAV4 2.0 TOP 4X2 AUT. 5P		2015		
RAV4 2.0 TOP 4X2 AUT. 5P		2017/2019		
RAV4 2.5 4X4 AUT. 5P		2013/2015		
RAV4 2.5 S AWD AUT. (HEV) 5P HIBRIDO		2020		
RAV4 2.5 S AWD AUT. 5P HIBRIDO		2019		
RAV4 2.5 S CON. AWD AUT. (HEV) 5P HIB. ELÉT.		2020		
TOYOTA RAV4 2.5 SX AWD AUT. (HEV) 5P HIB.		2020		
RAV4 2.5 SX AWD AUT. 5P HIB.	2020			
RAV4 2.5 SX CONNECT AWD AUT. (HEV) 5P HIB. ELÉT.	2019			
	2020/2021			
CITROËN	XM 3.0 EXCLUSIVE	1998		



YN-PF1822

CONEXÃO K

MARCA	MODELO	ANO	POLEGADAS MOT. PAX.
GM	AGILE	2009/2011	22" 18"
	MONTANA	2009/2011	
	VECTRA	2006/2008	
DAEWOO	NUBIRA	2003/2005	
	DOBLO	2001	
Ford	ECOSPORT	2005/2011	
	FIESTA	2005/2011	
JAC	J5	2010	
	BONGO	2004	





YN-PF1822

CONEXÃO K

MARCA	MODELO	ANO	POLEGADAS MOT. PAX.	
	GALANT PAJERO DAKAR	1996/2003 2011;	22" 18"	

YN-PF1921

CONEXÃO K

MARCA	MODELO	ANO	POLEGADAS MOT. PAX.	
	GOL III 1.0MI 16V	1999/2005	22" 18"	
	GOL III 1.0MI	1999/2001		
	GOL III 1.0MI	2001/2005		
	GOL III 1.0MI 16V TURBO	2000/2003		
	GOL III 1.0MI TOTAL FLEX;	2005/2006		
	GOL III 1.0MI	1999/2005		
	GOL III 1.6MI TOTAL FLEX	2003/2005		
	GOL III 1.6MI	1999/2005		
	GOL III 1.6MI	1999/2005		
	GOL III 1.8MI TOTAL FLEX	2005		
	GOL III 1.8MI	1999/2003		
	GOL III 2.0MI	1999/2002		
	GOL III 2.0MI 16V GTI	1999/2000		
	GOL IV 1.0	2005/2008		
	GOL IV 1.0 TOTAL FLEX	2005/2013		
	GOL IV 1.0 TOTAL FLEX	2005/2008		
	GOL IV 1.6 TOTAL FLEX	2006/2008		
	GOL IV 1.6 TOTAL FLEX	2005/2006		
	GOL IV 1.8 TOTAL FLEX	2005/2008		
	POLO 1.0 16V	2002/2005		
	POLO 1.6 (05.2002 - 07.2006);	2002/2006		
	POLO 1.6 TOTAL FLEX	2006/2008		
	POLO 1.6 TOTAL FLEX	2008/2014		
	POLO 1.6 TOTAL FLEX	2004/2006		
	POLO 2.0	2002/2006		
	POLO CLASSIC 1.8MI	1998/2003		
	POLO SEDAN 1.6 TOTAL FLEX	2008/2014		
	POLO SEDAN 1.6 TOTAL FLEX;	2006/2008		
	POLO SEDAN 1.6	2002/2006		
	POLO SEDAN 1.6 TOTAL FLEX	2004/2006		
	POLO SEDAN 2.0 FLEX	2008/2014		
	POLO SEDAN 2.0	2006/2008		
	POLO SEDAN 2.0	2002/2006		
	POLO 2.0 GT FLEX	2008/2012		
	SAVEIRO II 1.8MI	1997/2000		
	SAVEIRO III 1.6MI	2000/2003		
	SAVEIRO III 1.6MI TOTAL FLEX	2003/2005		
	SAVEIRO III 1.6MI	2000/2003		
	SAVEIRO III 1.8MI TOTAL FLEX	2005		
	SAVEIRO III 1.8MI	2000/2005		
	SAVEIRO III 2.0MI	2000/2005		
	SAVEIRO IV 1.6 TOTAL FLEX	2005/2006		
	SAVEIRO IV 1.6 TOTAL FLEX	2006/2009		
	SAVEIRO IV 1.8 TOTAL FLEX	2005/2009		
	GOLF IV 1.6	2001/2007		
	GOLF IV 1.6	1999/2001		
	GOLF IV 1.6 TOTAL FLEX	2007/2008		
	GOLF IV 1.6 TOTAL FLEX	2006/2007		
	GOLF 2.0 CABRIOLET	1996/1998		
	GOLF III 1.8	1992/1999		
GOLF III 1.8MI	1996/1998			
GOLF III 2.0MI	1994/1998			
GOLF III 2.0	1992/1999			
GOLF IV 1.8	2001/2007			
GOLF IV 1.8 GTI TURBO	1999/2002			
GOLF IV 1.8 GTI TURBO	2002/2007			
GOLF IV 1.8 GTI TURBO	2000/2001			
GOLF IV 1.8 GTI TURBO	2007/2008			
GOLF IV 2.0	2007/2008			
GOLF IV 2.0	1999/2002			
GOLF IV 2.0	2007/2008			
GOLF IV 2.8 VR6	2002/2003			
PARATI III 1.0MI 16V	1999/2003			
PARATI III 1.0MI 16V TURBO	2000/2004			
PARATI III 1.6MI	1999/2005			
PARATI III 1.6MI TOTAL FLEX	2003/2005			
PARATI III 1.6MI	1999/2005			
PARATI III 1.8MI	1999/2005			
PARATI III 1.8MI TOTAL FLEX	2005			
PARATI III 2.0MI	1999/2005			
PARATI III 2.0MI 16V GTI	1999/2000			
PARATI IV 1.6 TOTAL FLEX	2005/2006			
PARATI IV 1.6 TOTAL FLEX	2006/2012			
PARATI IV 1.8 TOTAL FLEX	2005/2008			
BORA 2.0	2002/2012			
BORA 2.0 TOTAL FLEX	2008/2010			

YN-PF1822

CONEXÃO K

MARCA	MODELO	ANO	POLEGADAS MOT. PAX.	
	HILUX 2.5 16V D TURBO	2005/2011	22" 18"	
	HILUX 2.7 16V SW4 FLEX	2012;		
	HILUX 2.7 16V FLEX	2012;		
	HILUX 2.7 16V	2008/2012		
	HILUX 3.0 16V TURBO INTERCOOLER	2005/2011		
	A3 1.8	1999/2006		
	A3 1.8 T	1999/2006		
	A3 1.6	2000/2006		
	CIVIC 1.7I 16V LX SEDAN	2001/2006		
	CIVIC 1.7I 16V EX SEDAN	2001/2006		
	CORDOBA 1.8	1995/1999		
	CORDOBA VARIO 1.6	1999/2004		
	IBIZA 1.6	1995/1999		
	KC2700 2.7 DIESEL	2004;		
	K 2700	1998/2004		
	SEPHIA I 1.6I 16V	1995/1997		
	ASTRA 2.0 MPFI	1998/2008		
	370 Z 3.7 COUPE	2009;		

CINOY
 PRODUTOS AUTOMOTIVOS

14" - 28"





PALHETAS HÍBRIDAS



Design simplificado
 produzida em material
 de qualidade excelente!

YN-PH014

CONEXÃO B

MARCA	MODELO	ANO	POL
	500	****	14"
	KICKS	****	
	S-CROSS	****	
	COROLLA	****	

YN-PH016

CONEXÃO B

MARCA	MODELO	ANO	POL
	SPIDER	1984/1994	16"
	GALOPER TOPIC TOWNER	1998/1999 1993/2000 1993/1999	
	MOBI UNO	2016/2024 2011/2024	
	FIT	2003/2008	
	HB20 HB20S HB20X TUCSON IX35	2012/2024 2012/2024 2012/2024 2004/2024 2010/2024	
	MURANO TIIDA TIIDA SEDAN XTRAIL	2007/2011 2008/2013 2011/2013 2001/2009	
	206 206 CC 206 SW 207 207 HOGGAR 207 SW 207 SEDAN	1998/2009 2001/2008 2005/2008 2008/2024 2010/2014 2008/2014 2008/2014	
	MÉGANE SCÉNIC SCENIC	1993/2000 1997/2010	
	SIDEKICK VITARA	1990/1998 1990/1998	
	GOL GOL SPECIAL G4 VOYAGE KOMBI PICK-UP KOMBI FURGÃO SAVEIRO G5	2008/2012 2014/2024 2008/2012 2012/2013 1975/2012 2010/2012	

YN-PH017

CONEXÃO B

MARCA	MODELO	ANO	POL
	KA KA KA G2	1997/2001 2002/2008 2008/2010	17"

YN-PH018

CONEXÃO B

MARCA	MODELO	ANO	POL
	825 MICRO ÔNIBUS KOMBI AM 815 TOPIC	1997/2001 1997/2001 2008/2024	18"
	BRASIL SILVERADO AGILE ASTRA HATCH S2 ASTRA HATCH CELTA CELTA CELTA CORSA HATCH 5P CORSA HATCH 3P CORSA HATCH CLASSIC CORSA HATCH CORSA HATCH CORSA PICKUP CORSA SEDAN CORSA WAGON CRUSE SEDAN CRUSE SPORT GRAND BLAZER IPANEMA KADETT GL, GLS, SL, SL/E KADETT SPORT, GSI, GS KADETT, GLS MONZA MONZA HATCH PRISMA SPIN TIGRA VECTRA MONTANA MONTANA	2010/2011 1995/1997 1995/1997 1995/1997 1999/2011 2001/2003 2014/2024 1994/2002 1994/2002 1995/2024 2001/2003 2004/2012 1995/2003 1995/2024 2001/2011 1997/2002 2011/2024 2011/2024 1998 1990/1998 1989/1997 1989/1997 1998 1984/1996 1984/1988 2006/2012 2013/2024 1998/2000 2006/2008 2003/2010 2011	
	PLUTUS	2011/2012	
	RANGER SÉRIE F ECOSPORT ECOSPORT ESCORT XR3 EXPLORER FIESTA HATCH G2 FUSION HOBBY VERONA VERSAILLES VERSAILLES ROYALE	1993/2012 1992/1998 2008/2024 2005/2012 1984/2002 1991/2002 2002/2004 2006/2012 1993/1998 1990/1992 1991/1996 1992/1996	
	H3	2005/2024	
	BESTA BESTA BONGO BONGO	1993/1997 1998/2005 1998/2004 2005/2024	
	PICK-UP B2500 MX-3 MX-3 MX-5 MIATA PROTEGÉ	1997/2000 1991/1993 1994/1998 1990/1995 1991/2000	
	FRONTIER 350Z PATHFINDER SENTRA G2	2007/2024 2002/2009 2005/2009 2005/2006	













YN-PH018

CONEXÃO B

MARCA	MODELO	ANO	POL
	VAN APOLLO POLO CLASSIC	1997/2002 1990/1992 1997/2000	18"
	M5 SÉRIE 5 SÉRIE 7	1985/1988 1980/1990 1977/1986	
	TIGGO	2009/2024	
	NEON	1994/1999	
	C3, C3 XTR C5, C5 BREAK XANTIA XANTIA BREAK	2002/2012 2001/2003 1993/2003 1995/2003	
	NUBIRA NUBIRA WAGON TICO	2003/2005 2003/2005 1992/2000	
	CHARADE, CHARADE SEDAN CUORE CUORE GRAN MOVE	1993/1999 1993/1999 2001/2003 1997/1999	
	JOURNEY	2008/2024	
	DOBLO DOBLO DOBLO ELBA ELBA FREEMONT MAREA MAREA WEEKEND PALIO, PALIO ADVENTURE PALIO YOUNG PALIO ADVENTURE G2 PALIO ADVENTURE G3 PALIO ADVENTURE G4 PALIO G2 PALIO G3 PALIO G4 SIENA SIENA G2 SIENA G3 SIENA G4 STILO STRADA STRADA G2, G3, G4	2001/2004 2004/2009 2010/2024 1986/1994 1995/1997 2011/2015 1998/2007 1998/2007 1999/2000 2001/2002 2001/2003 2004/2007 2008/2024 2001/2007 2004/2024 2008/2024 1997/2000 2001/2024 2001/2024 2001/2024 2002/2011 1998/2001 2001/2024	
	ACCENT COUPE FX ELANTRA ELANTRA SW EXCEL SANTA FÉ 130 130 CW H100	1994/2001 1996/2009 1990/1998 1996/1998 1990/1994 2007/2012 2008/2012 2008/2012 1993/2001	
	ACCORD ACCORD CIVIC LEGEND PRELUDE	1997/2001 1997/2001 2008/2024	



YN-PH018

CONEXÃO B

MARCA	MODELO	ANO	POL
	J5	2010/2024	18"
	CHEROKEE CHEROKEE	1993/1996 1997/2001	
	CARENS CARENS G2 CARNIVAL G3 K2700 MAGENTIS MAGENTIS OPIRUS APTIMA SORENTO SPORTTAGE G3	2000/2002 2003/2006 2007/2010 1998/2004 2001/2005 2006/2010 2003/2009 2012/2024 2003/2009 2011/2024	
	DISCOVERY RANGE ROVER	1989/1998 1991/1994	
	ES 300	1997/2005	
	320 520 SUV X60	2010/2024 2010/2024 2010/2024 2010/2024	
	L200 TRITON L300 COLT GALANT GALANT LANCER LANCER PAJERO DAKAR SPACE WAGON	2008/2024 1991/2000 1992/1995 1993/1997 1997/2004 1993/1995 2003/2007 2010/2024 1992/1998	
	280 450 CLASSE S (W116)	1972/1980 1972/1980	
	COOPER S COOPER MINI CABRIOLET MINI CLUBMAN ONE	2001/2013 2001/2013 2004/2013 2007/2013 2001/2013	
	MEGANE MEGANE GRAND TOUR CLIO G2 CLIO SEDAN G2 LAGUNA LAGUNA GRAND TOUR	2006/2011 2006/2012 2000/2009 1994/2000 1995/2000 1995/2000	
	CORDOBA IBIZA INCA	1993/1999 1994/1999 1999/2002	
	ACTION ACTION SPORTS KORANDO KYRON MUSSO	2006/2024 2006/2024 1997/2010 2009/2024 1999/2005	
	BALENO GRAND VITARA IGNIS JIMMY SWIFT HATCH WAGON R+	1995/2002 2008/2024 2000/2003 1998/2024 1993/1999 1997/1999	

YN-PH018

CONEXÃO B

MARCA	MODELO	ANO	POL
	FORESTER IMPREZA IMPREZA IMPREZA WAGON IMPREZA WAGON LEGACY LEGACY OUTBACK LEGACY WAGON	2008/2024 1993/2000 2001/2007 1993/2000 2001/2007 2003/2009 2003/2009 2003/2009	18"
	CAMRY COROLLA COROLLA FIELDER COROLLA WAGON COROLLA WAGON CORONA PASEO RAV4 RAV4 G2	2001/2006 1992/2008 2004/2008 1992/1996 1997/2001 1992/2000 1996/1999 1994/2000 2000/2005	
	106 106 205	1991/2001 2001/2004 1983/1998	

YN-PH019

CONEXÃO B

MARCA	MODELO	ANO	POL
	145 166	1997/2001 1998/2003	19"
	A3 S3	1996/2006 1999/2003	
	CIELO	2010/2012	
	NEON II	1999/2005	
	POLO CLASSIC POLO HATCH POLO HATCH POLO SEDAN SAVEIRO G3 SAVEIRO G4 SAVEIRO G4 BORA GOL G3 GOL SPECIAL G2 GOL G4 GOL G4 GOLF G3 PARATI PARATI G3 PARATI G4	2001/2002 2002/2008 2009 2002/2009 2000/2008 2000/2008 2009/2010 2003/2005 1999/2005 2001/2005 2005/2008 2009/2013 1993/1998 2003/2005 1999/2002 2009/2012	
	S40 V40	1996/2003 1996/2004	
	FORESTER LEGACY	1997/2007 1994/1999	
	ESPERO LANOS HATCH LEGANZA	1994/1997 1997/1999 1997/1999	
	GRAND VITARA	1998/2007	

YN-PH019

CONEXÃO B

MARCA	MODELO	ANO	POL
	FIESTA HATCH	1996/2007	19"
	FIESTA HATCH STREET	1996/2007	
	FIESTA SEDAN	2001/2004	
	FOCUS HATCH	2000/2010	
	FOCUS SEDAN	2000/2010	
	KA	1997/2001	
	KA G2	2002/2008	
	ACCORD	1989/1999	
	CRV	1995/2001	
	CIVIC	2001/2006	
	X-TYPE	2001/2009	
	CHEROKEE LIMITED	2002/2013	
	CHEROKEE	2002/2013	
	CHEROKEE SPORT	2002/2013	
	LIBERTY	2002/2024	
	CLARUS	1996/1999	
	CLARUS WAGON	1998/1999	
	SEPHIA	1993/1997	
	SHUMA	1996/2001	
	SHUMA G2	2001/2004	
	626	1998/2002	
	626 WAGON	1998/2002	
	AIRTREK	2003/2008	
	COLT	1995/1997	
	LANCER	1996/2002	
	PAJERO	1991/2000	
	PAJERO TR4	2002/2009	
	PAJERO TR4	2010/2024	
	KING CAB	1993/1996	
	PICK UP	1993/1996	
	PRIMERA	1990/1995	
	SENTRA	1995/1997	
	XTERRA	2003/2008	
	FRONTIER	1997/2007	
	CORDOBA	2000/2002	
	IBIZA	2000/2003	
	COUPE	1993/2000	
	ELBA	1986/1994	
	ELBA	1995/1997	
	PREMIO	1985/1996	
	UNO	1984/1994	
	UNO	1995/2013	
UNO MILLE	1984/1994		
	UTILITÁRIO LEVE		
	FIORINO	1987/2013	
	CAMRY	1991/2000	
	CAMRY WAGON	1992/1993	
	HILUX	2005/2024	
	HILUX SW4	2005/2024	
	CALIBRA	1994/1997	
	TRACKER	2000/2009	
	VECTRA	1993/2005	

YN-PH020

CONEXÃO B

MARCA	MODELO	ANO	POL
	155	1992/1997	20"
	80	1991/1994	
	80 AVANT	1991/1996	
	80 CABRIOLET	1991/1998	
	A4	1995/2000	
	A4 AVANT	1995/2001	
	S4	1997/1999	
	M ROADSTER	1999/2003	
	M4 (E36)	1994/1998	
	SÉRIE 3 (E36)	1990/1998	
	SÉRIE 3 COUPE	1992/1999	
	SÉRIE 3 CABRIO (E36)	1993/1999	
	SÉRIE COMPACT (E36)	1994/1996	
	SÉRIE TOURING (E36)	1995/1999	
	Z3	1995/2003	
	Z4 (E85/E89)	2003/2024	
	COROLLA	1992/2001	
	COROLLA WAGON	1992/2001	
	CORONA	1992/2000	
	PASEO	1996/1999	
	RAV4	1994/2000	
	ESCORT SW	1997/2003	
	MUSTANG	1994/2004	
	TAURUS	1992/1996	
	VERONA	1994/1996	
	ESCORT XR3	1993/1996	
	ESCORT SEDAN	1997/2002	
	ESCORT	1997/2002	
	ESCORT SW	1997/2003	
	MUSTANG	1994/2004	
	TAURUS	1992/1996	
	VERONA	1994/1996	
	ASX	2011/2024	
	AIRTREK	2003/2008	
	COLT	1992/1995	
	ECLIPSE	1992/1995	
	LANCER	1993/1995	
	OUTLANDER	2007/2013	
	PAJERO FULL	2006/2013	
	PAJERO SPORT	1999/2011	
	SAVANA	2004/2012	
L200 SPORT	2004/2012		
L200 OUTDOOR	2004/2012		
	350Z	2002/2009	
	NEON	1994/1999	
	PT CRUISER	2000/2011	
	NUBIRA	1993/2003	
	NUBIRA WAGON	1997/2003	
	F355 BERLINETA	1994/1998	
	TEMPRA	1992/1999	
	TEMPRA SW	1995/1997	
	TIPO	1994/1997	
	CORDOBA	1993/1999	
	IBIZA	1994/1999	
	INCA	1999/2002	

YN-PH020

CONEXÃO B

MARCA	MODELO	ANO	POI
	ACCENT	1997/2003	20"
	ATOS	1994/2004	
	ATOS PRIME	1992/1996	
	AZERA	1994/1996	
	ELANTRA	1990/1998	
	ELANTRA SW	1996/1998	
	H1	2008/2024	
	SONATA	1993/2010	
	HR	2005/2024	
	COMPASS	2012/2024	
	GRAND CHEROKEE	1993/2010	
	FREELANDER	1998/2006	
	MX-3	1991/1998	
	PROTEGÉ	1991/2000	
	200T	1976/1985	
	207D	1988/1996	
	300-TE TURBO DIESEL	1976/1985	
	410	1988/1996	
	MB 180D	1988/1996	
	IMPREZA	1993/2000	
	BALENO WAGON	1995/2002	
	BALENO	1995/2002	
	GRAND VITARA	2008/2024	
	SWIFT HATCH	1993/1999	
	WAGON R+	1997/1999	
	DAKOTA	1995/2003	
	RAM PICKUP	1993/2001	
	CERATO	2010/2013	
	CERATO KOUP	2010/2013	
	K2700	1998/2004	
	SOUL	2009/2014	
	SPORTAGE	1994/2004	
	BESTA BONGO	1998/2005 1998/2004	
	106	1991/2004	
	19 SEDAN	1989/1997	
	19	1989/1997	
	21 NEVADA	1989/1994	
	21	1989/1994	
	CLIO	1994/1999	
	CLIO G2	1999/2009	
	DUSTER	2012/2024	
	LOGAN	2007/2013	
	MEGANE	1997/2005	
	SANDERO	2008/2014	
	OROCH	2015/2024	
	TRAFIC	1994/2002	
	ASTRA HATCH	1999/2011	
	BLAZER	1996/2012	
	CORSA HATCH	2001/2003	
	CORSA SEDAN	2001/2011	
	SPACE VAN	1994/1998	
	MONATANA	2003/2010	
	S10 VAN I	1995/2011 1997/1998	

YN-PH020

CONEXÃO B

MARCA	MODELO	ANO	POI	
	GOL G2	1995/2001	20"	
	LOGUS	1993/1997		
	PARATI G2	1996/1999		
	PASSAT G4	1993/2001		
	PASSAT G5	1998/2002		
	POINTER	1994/1996		
	POLO CLASSIC	1997/2000		
	QUANTUM	1998/2002		
	SANTANA	1998/2006		
	VAN	1997/2002		
		460	1990/1996	
		850	1991/1996	
850 SPORTSWAGON		1991/1996		
960		1997/2002		
C70		1997/2000		
S70		1997/2000		
V70		1997/2000		
	MUSSO	1999/2005		
	REXTON II	2002/2005		

YN-PH021

CONEXÃO B

MARCA	MODELO	ANO	POI
	CAMRY	1991/2000	21"
	CAMRY WAGON	1994/1999	
	HILUX	2005/2024	
	HILUX SW4	2005/2024	
	BORA	1998/2011	
	GOL G2	2001/2005	
	GOL G3	1999/2005	
	GOL G4	2005/2013	
	PARATI G3	1999/2002	
	PARATI G4	2005/2012	
	POLO CLASSIC	2001/2002	
	POLO HATCH	2002/2009	
	POLO SEDAN	2002/2009	
	SAVEIRO G3 SAVEIRO G4	2000/2008 2009/2010	
	AIRTREK	2003/2008	
	COLT	1995/1997	
	LANCER	1996/2002	
	NEON G2	1999/2005	
	LEGANZA	1997/1999	
	COUPE	1993/2000	
	FOCUS SEDAN	2000/2010	
	ACCORD	1989/1992	
	CIVIC	2001/2006	
	X-TYPE	2001/2009	
	FORESTER	1997/2007	
	LEGACY	1994/1999	

YN-PH021

MARCA	MODELO	ANO	POL
	CLARUS	1996/1999	21"
	CLARUS WAGON	1998/1999	
	SEPHIA	1993/1997	
	SHUMA	1996/2001	
	SHUMA G2	2001/2004	
	626	1998/2002	
	626 WAGON	1998/2002	
	145	1999/2005	
	166	2002/2005	
	A3	1999/2005	
	S3	2002/2005	
	CIELO SEDAN	1999/2005	
		2002/2005	
	AGILE	2010/2011	
	MONTANA	2011	
	MARCH	2012/2024	
	PRIMERA	1990/1995	
	SENTRA	1995/1997	
	CORDOBA	2000/2002	
	IBIZA	2000/2003	

YN-PH022

CONEXÃO B

MARCA	MODELO	ANO	POL
	100	1900/1994	22"
	100 AVANT	1990/1994	
	A6	1994/2001	
	A8	1994/2002	
	S18	2010/2013	
	S4	1991/1994	
	S6	1994/1997	
	S8	1996/2002	
	FACE	2010/2024	
	AGILE	2010/2011	
	SPIN	2013/2024	
	VECTRA	2006/2008	
	MONTANA	2011	
	300C TOURING	2004/2011	
	300C	2004/2011	
	300M	1998/2004	
	SEBRING	2001/2006	
	STRATUS	1995/2001	
	AX	1986/1998	
	BERLINGO	1996/2024	
	XM	1989/1994	
	XM BREAK	1994/2000	
	ZX	1989/2000	
	JUMPER	1994/2002	
	QUEST	1992/1995	
	SENTRA	2005/2006	
	TIIDA	2008/2013	
	TIIDA SEDAN	2011/2013	
	NUBIRA WAGON	2003/2005	





YN-PH022

CONEXÃO B

MARCA	MODELO	ANO	POL
	147	2001/2005	22"
	DOBLO	2001/2009	
	STILO	2002/2011	
	DUCATO, DUCATO CARGO	1998/2024	
	COMBINATO MAXICARGO	1998/2024 1998/2024	
	GALANT	1993/2004	
	PAJERO DAKAR	2010/2024	
	SPACE WAGON L200 TRITON	1992/1998 2008/2024	
	405	1990/1999	
	605	1990/1999	
	BOXER PARTNER	1998/2024 1996/2024	
	MEGANE	1997/2005	
	CROSSFOX	2004/2012	
	FOX	2003/2012	
	GOL G4	2008/2012	
	GOL G5	2014/2024	
	SPACECROSS	2006/2012	
	SPACEFOX	2006/2012	
	VOYAGE SAVEIRO G5	2008/2012 2010/2012	
	RAM PICKUP	2012/2024	
	CLASSE C	2000/2003	
	CLASSE C STATION WAGON	2001/2003	
	CLASSE M	1998/2005	
	CLASSE SLK SPRINTER	1996/2004 1995/2012	
	ODYSSEY	1995/1998	
	COUPE FX	1996/2009	
	J3	2011/2024	
	J3 TURIN	2011/2024	
	J5	2010/2024	
	CARNIVAL	2007/2010	
	MAGENTIS	2001/2005	
	PICANTO	2006/2024	
	BONGO	2005/2024	
	RANGE ROVER G2	1994/2002	
	ES 300	1997/2005	
	ECOSPORT	2005/2012	
	EXPLORER	2003/2005	
	FIESTA HATCH G2	2005/2011	
	FIESTA SEDAN G2	2005/2011	
	FOCUS HATCH	2000/2010	
	FOCUS SEDAN	2000/2010	
	TRANSIT	2009/2024	
	SÉRIE F (F250, F350)	1998/2024	

YN-PH024

CONEXÃO B

MARCA	MODELO	ANO	POL
	EQUINOX	****	24"
	500	****	
	HB20 HB20X HB20S	****	
	VITARA NOVO	****	
	RAV4 IV	****	

YN-PH026

CONEXÃO B

MARCA	MODELO	ANO	POL
	MURANO	2007/2011	26"
	TRANSIT	2009/2024	
	XSARA PICASSO	2000/2012	

PALHETAS HÍBRIDA UNIVERSAL



REVESTIMENTO ARTICULADO

FÁCIL INSTALAÇÃO
0%
 DANIFICAÇÃO





14" - 28"

PALHETAS DIANTEIRA MULTI ENCAIXES



Design simplificado produzida em material de qualidade excelente!



CÓDIGO:	POL.:	MM:
YN-PM1184	14"	355,60mm
YN-PM1185	15"	381mm
YN-PM1186	16"	406,40mm
YN-PM1187	17"	431,80mm
YN-PM1188	18"	457,20mm
YN-PM1189	19"	482,60mm
YN-PM1190	20"	508mm
YN-PM1191	21"	533mm
YN-PM1192	22"	558,80mm
YN-PM1193	24"	609,6mm
YN-PM1194	26"	660,40mm
YN-PM1195	28"	711,20mm



DESIGN SIMPLIFICADO!
PRODUZIDO EM MATERIAIS DE QUALIDADE EXCELENTE!

AJUSTE PERFEITO E TROCA FÁCIL ENTRE OS ENCAIXES.

RESISTENTE E DURADOURA. FAZ A LIMPEZA IDEAL MESMO SOB CONDIÇÕES EXTREMAS.



ENCAIXES DIANTEIROS
AS PALHETAS DIANTEIRAS MULTIENCAIXES POSSUEM 7 (SETE) ENCAIXES E 1 (UMA) PALHETA POR EMBALAGEM INTERNA.

14"

YN-PM1284

CHEVROLET	ENCAIXE A
MODELOS	ANO
PRISMA	2013/2018
PRISMA JOY	2017/2021
PRISMA/PRISMAJOY	2018/2021
TRACKER	2013>
ONIX	2007/2012
FIAT	ENCAIXE A
MODELOS	ANO
PUNTO	*****
500 POLONES	
FORD	ENCAIXE A
MODELOS	ANO
RANGER	2017/2021
HONDA	ENCAIXE A
MODELOS	ANO
CITY	2009/2014
CITY	2018/2021
HRV (PALHETA SLIM BLADE)	2018/2021
FIT	2015/2017
FIT	2009/2014

15"

YN-PM1185

CHEVROLET	ENCAIXE A
MODELOS	ANO
OMAGA III	2007/2012
VERANEIO	1964/1988
SONIC/ SONIC SEDAN	2012/2014
CITROEN	ENCAIXE A
MODELOS	ANO
*****	****
FORD	ENCAIXE A
MODELOS	ANO
SÉRIE F (TODOS)	2017/2021
GURGEL	ENCAIXE A
MODELOS	ANO
X12	1981/1991
CARAJÁS X15	1986/1991
BR 800	1989/1991
SUPERMINI	1992/1995
PEUGEOT	ENCAIXE A
MODELOS	ANO
208	2019/2021
2008	2020/2021
VOLKSWAGEN	ENCAIXE A
MODELOS	ANO
SPACEFOX/CROSS (MODELO COM PALHETAS SLIM BLADE)	2013/2019
CROSSFOX/FOX	2012>
VOLKSWAGEN	ENCAIXE A
MODELOS	ANO
SPACEFOX/CROSS (MODELO COM PALHETAS SLIM BLADE)	2013/2019
CROSSFOX/FOX	2012>

16"

YN-PM1186

CHEVROLET	ENCAIXE A
MODELOS	ANO
CARAVAN/COMODORO/DIPLOMATA	1975/1992
CHEVETTE	1973/1993
CHEW 500	1983/1995
MARAJÓ	2007/2015

17"

YN-PM1187

FORD	ENCAIXE A
MODELOS	ANO
KA II	2010/2013
KA III	2014>
CITROEN	ENCAIXE A
MODELOS	ANO
*****	****
FORD	ENCAIXE A
MODELOS	ANO
SÉRIE F (TODOS)	2017/2021
GURGEL	ENCAIXE A
MODELOS	ANO
X12	1981/1991
CARAJÁS X15	1986/1991
BR 800	1989/1991
SUPERMINI	1992/1995
PEUGEOT	ENCAIXE A
MODELOS	ANO
208	2019/2021
2008	2020/2021
VOLKSWAGEN	ENCAIXE A
MODELOS	ANO
SPACEFOX/CROSS (MODELO COM PALHETAS SLIM BLADE)	2013/2019
CROSSFOX/FOX	2012>
VOLKSWAGEN	ENCAIXE A
MODELOS	ANO
SPACEFOX/CROSS (MODELO COM PALHETAS SLIM BLADE)	2013/2019
CROSSFOX/FOX	2012>

18"

YN-PM1188

CHEVROLET	ENCAIXE A
MODELOS	ANO
S10	2012/2021
VECTRA (MODELO NOVO/COM SLIM BLADE)	2009>
CITROEN	ENCAIXE A
MODELOS	ANO
C5/C5 BREAK	2004/2007
FIAT	ENCAIXE A
MODELOS	ANO
BRAVO	2011/2016
GURGEL	ENCAIXE A
MODELOS	ANO
XEF	1982/1986
G15	1982/1986
HYUNDAI	ENCAIXE A
MODELOS	ANO
EQUUS	2011>
130/130 CW (MODELO ANTIGO SLIM BLADE)	2008/2012
MERCEDEZ-BENS	ENCAIXE A
MODELOS	ANO
CLASSE M	2005/2011
PUMA	ENCAIXE A
MODELOS	ANO
GTB	1976/1987

18"

YN-PM1188

VOLKSWAGEN	ENCAIXE A
MODELOS	ANO
POLO SEDAN	2001/2002
VARIANT II	1977/1983
BRASILIA	1973/1982
PASSAT VI	2005/2011
VIRTUS	2018/2021
GOL V/GOL VII VARIANT	2014/2018
POLO	2010/2015
POLO GTI (BLUEMOTION)	2016/2021
PASSAT CC	2009/2015
PASSAT VI VARIANT	2008/2011
	2005/2011

19"

YN-PM1189

AUDI	ENCAIXE A
MODELOS	ANO
M6 COUPÉ	2008/2014
FORD	ENCAIXE A
MODELOS	ANO
KA III	2014>
KA II	2010/2013
LAND ROVER	ENCAIXE A
MODELOS	ANO
RANGE ROVER VELAR	2017/2021
VOLKSWAGEN	ENCAIXE A
MODELOS	ANO
JETTA	2007/2010
EOS	2006/2012
GOLF IV	2005/2007

20"

YN-PM1190

AUDI	ENCAIXE A
MODELOS	ANO
A5 COUPÉ	2007
A4 AVANT	2007/2015
ASSPORTBACK	2009>
A4/A4 ALLROAD/A4 AVANT	2015>
BMW	ENCAIXE A
MODELOS	ANO
SÉRIE 1	2004/2011
X3	2011>
X4	2014/2017
X5	1996/2011
X5	2011/2013
X6	2011/2014
JEEP	ENCAIXE A
MODELOS	ANO
RENEGADE	2015>
MERCEDEZ-BENS	ENCAIXE A
MODELOS	ANO
SÉRIE L	1978/1988
608/708	1988>
PUMA	ENCAIXE A
MODELOS	ANO
4T/6T	1979/1984
VOLKSWAGEN	ENCAIXE A
MODELOS	ANO
CAMINHÃO VW	1981/1992

20"

YN-PM1190

VOLVO	ENCAIXE A
MODELOS	ANO
S40 II	2003/2011
V50	2005/2011
C30	2006>
XC60	2011/2021
V60	2010>

21"

YN-PM1191

AUDI	ENCAIXE A
MODELOS	ANO
A5 CABRIOLET	2009>
R8	2010/2017
BMW	ENCAIXE A
MODELOS	ANO
SÉRIE 1	2012>
CHERY	ENCAIXE A
MODELOS	ANO
TIGGO 5X	2018/2021
TIGGO 7	2018/2021
CHEVROLET	ENCAIXE A
MODELOS	ANO
S10	2019/2021
TRAILBLAZER	2007
VECTRA (MODELO NOVO/COM SLIM BLADE)	2009>
CITROEN	ENCAIXE A
MODELOS	ANO
C5/C5 BREAK	2008>

20"

YN-PM1190

FORD	ENCAIXE A
MODELOS	ANO
FIESTA SEDAN II	2011/2014
FIESTA II	2011/2014
JEEP	ENCAIXE A
MODELOS	ANO
RENEGADE	2015>
LAND ROVER	ENCAIXE A
MODELOS	ANO
RANGE ROVER EVOQUE	2011>

22"

YN-PM1191

BMW	ENCAIXE A
MODELOS	ANO
SÉRIE 6/CABRIO/ GC	2011>
CHEVROLET	ENCAIXE A
MODELOS	ANO
TRAILBLAZER	2008/2014
VOLKSWAGEN	ENCAIXE A
MODELOS	ANO
AMAROK	2010/2012

24"

YN-PM1193

AUDI	ENCAIXE A
MODELOS	ANO
A3/A3 (SPORTBACK)	2001/2006
A3/A3(SPORTBACK)	2007/2012
S3	2008/2014
A5 COUPÉ	2007/2007
A4 AVANT	2007/2015
ASSPORTBACK	2009/...
A4 ALLROAD	2015/...
A4 AVANT	2015/...
A4/A4ALLROAD	2015/...
A5 CABRIOLET	2009/...
R8	2010/2017
Q7	2006/2015

CHEVROLET	ENCAIXE A
MODELOS	ANO
PRISMA	2013/2018
PRISMA JOY	2017/2021
PRISMA/PRISMAJOY	2018/2021
MALIBU	2007/2012
CRUZE/CRUZE SPORT	2001/2006
ONIX	2007/2012

CITROEN	ENCAIXE A
MODELOS	ANO
AIRCROSS	2011/2014
C3 PICASSO	2011/2014
C4 PALLAS	2005/2014
C4 PICASSO	2008/2013

FIAT	ENCAIXE A
MODELOS	ANO
ARGO	2017/2021
CRONOS	2018/2021
IDEA/ADVENTURE	2014/2016
IDEA/ADVENTURE	2016/2021
BRAVO	2011/2016
500 POLONES	2009/2011
PALIO V	2012/2016
PALIO V	2016/2017
IDEA/ADVENTURE	2010/2013

FORD	ENCAIXE A
MODELOS	ANO
RANGER	2017/2021

GURGEL	ENCAIXE A
MODELOS	ANO
RANGER	2017/2021

HONDA	ENCAIXE A
MODELOS	ANO
CITY	2018/2021
CIVIC	2017/2021
FIT	2015/2017
CITY	2009/2014

HYUNDAI	ENCAIXE A
MODELOS	ANO
EQUUS	2011
130/130 CW (MODELO ANTIGO SLIM BLADE)	2008/2012

LAND ROVER	ENCAIXE A
MODELOS	ANO
RANGER ROVER EVOQUE	2011

MERCEDEZ-BENS	ENCAIXE A
MODELOS	ANO
CLASSE C - STATION WAGON (S204)	2009/2014
CLASSE C (W204)	2009/2014
CLFI	2013/2014
GLA	2013/2015
CLASSE E	2009/2012
CLASSE E - CABRIOLET	2010/2012
SPRINTER (MODELO NOVO)	2013

SMART	ENCAIXE A
MODELOS	ANO
FORTWO	2008/2015

24"

YN-PM1193

BMW	ENCAIXE A
MODELOS	ANO
SÉRIE 3 TOURING	1990/1999
SÉRIE 3 CABRIO (E36)	2010/2012
SÉRIE 3 COUPÉ (E92)	2010/2012
SÉRIE 6/CABRIO/ GC	2011/...
SÉRIE 4 (F30)	2013/...
SÉRIE 3 (F30)	2013/2018
X5	1996/2013
X6	2011/2014
SÉRIE 3 (E90)	2007/2012

VOLKSWAGEN	ENCAIXE A
MODELOS	ANO
JETTA	2007/2010
AMAROK	2010/2012
EOS	2006/2012
PASSAT VL	2005/2011
TIGUAN	2009/2017
TIGUAN ALL SPACE	2018/2021
UP!	2014
GOLF GLV	2005/2007
PASSAT CC	2008/2011
PASSAT VI VARIANT	2005/2011

VOLVO	ENCAIXE A
MODELOS	ANO
S80 I	2003/2006
XC90	2004/2006
XC70 II	2004/2007
S80 II	2006
XC90	2006/2010
XC90	2010/2016
S60	2004/2010

26"

YN-PM1194

AUDI	ENCAIXE A
MODELOS	ANO
Q7	2006/2015
A6/A6 (AVANT)	2010

BMW	ENCAIXE A
MODELOS	ANO
SÉRIE 7 (F01"2"4)	2008
X3	2011
M6 COUPÉ	2012
M5-(F10)	2014/2017
X4	2014/2017
SÉRIE 2	2016/2021

CHEVROLET	ENCAIXE A
MODELOS	ANO
OMAGA III	2007/2012
TRACKER	2013
BOLT	2019/2021
SONIC/SONIC SEDAN	2012/2014

CITROEN	ENCAIXE A
MODELOS	ANO
C4 LOUNGE	2013/2017
C4 PICASSO	2007/2008
CS/CS BREAK	2004/2007
DS4	****

FIAT	ENCAIXE A
MODELOS	ANO
LINEA	2008/2017
PUNTO	2008/2019

VOLKSWAGEN	ENCAIXE A
MODELOS	ANO
FOCUS SEDAN II	2008/2013
NEW FIESTA SEDAN	2010
FUSION IL (MODELO NOVO)	2013
NEW FIESTA HATCH	2010
FOCUS HATCH II	2008/2013

26"

YN-PM1194

HONDA	ENCAIXE A
MODELOS	ANO
CIVIC	2007/2011
HRV (PALHETA SLIM BLADE)	2018/2021
FIT	2009/2014

LAND ROVER	ENCAIXE A
MODELOS	ANO
RANGE ROVER VELAR	2017/2021

MERCEDEZ-BENS	ENCAIXE A
MODELOS	ANO
CLASSE CLS	2005/2011
CLASSE M	2005/2011
CLASSE E	2009/2012
CLASSE E - CABRIOLET	2010/2012
SPRINTER(MODELO NOVO)	2013
CLASSE SL	2001/2012
CLASSE E	2002/2008
CLASSE B	2005/2011

PEUGEOT	ENCAIXE A
MODELOS	ANO
RCZ	2011/...
508	2012/2014
408	2011/...
2008	2014/2019
308	2009/...
307/307 SW	2001/2012
307/307SEDAN/307SW/307CC	2006/2012
208	2012/2018
208	2019/2021
2008	2020/2021

VOLKSWAGEN	ENCAIXE A
MODELOS	ANO
TOUAREG	2004/2017
VIRTUS	2018/2021
GOLV GVL/GOLF GVL VARIANT	2014/2018
POLO	2016/2021

28"

YN-PM1195

CITROEN	ENCAIXE A
MODELOS	ANO
C4 LOUNGE	2013/2017
C4 PALLAS	2005/2014
C4 PICASSO	2007/2008
C4 PICASSO	2008/2013
C5/C5 BREAK	2008
C6	2005/2009
DS4	****

FORD	ENCAIXE A
MODELOS	ANO
FOCUS SEDAN III (MODELO NOVO)	2014
FUSION IL (MODELO NOVO)	2013
FOCUS HATCH III (MODELO NOVO)	2014

MERCEDEZ-BENS	ENCAIXE A
MODELOS	ANO
CLASSE S	2000/2013
GL 4MATIC	2006/2012
CLASSE B	2011/2014
CLASSE M	2011

PEUGEOT	ENCAIXE A
MODELOS	ANO
3008	2010/2017
308	2009
307/307 SW	2001/2012
307/307SEDAN/307SW/307CC	2006/2012



10" - 16"

PALHETAS TRASEIRA MULTI ENCAIXES



Design simplificado produzida em material de qualidade excelente!



ENCAIXES A

CÓDIGO:	POL.:
YN-PR1269	10"
YN-PR1270	11"
YN-PR1271	12"
YN-PR1272	13"
YN-PR1273	14"
YN-PR1274	15"
YN-PR1275	16"



DESIGN SIMPLIFICADO!
PRODUZIDO EM MATERIAIS
DE QUALIDADE EXCELENTE!

AJUSTE PERFEITO E TROCA
FÁCIL ENTRE OS ENCAIXES.

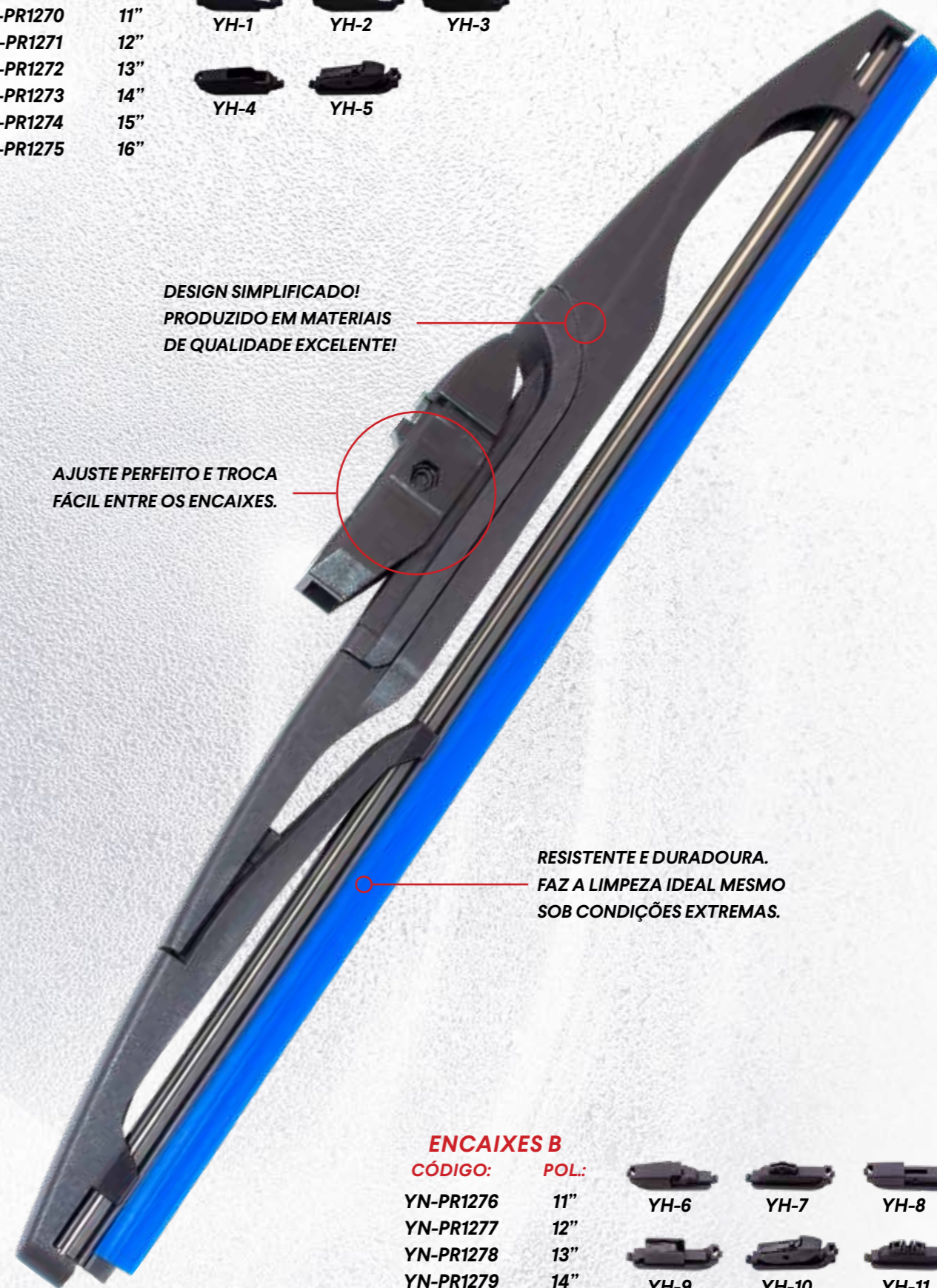

RESISTENTE E DURADOURA.
FAZ A LIMPEZA IDEAL MESMO
SOB CONDIÇÕES EXTREMAS.

ENCAIXES B

CÓDIGO:	POL.:
YN-PR1276	11"
YN-PR1277	12"
YN-PR1278	13"
YN-PR1279	14"
YN-PR1280	15"
YN-PR1281	16"



* Apenas referências YN-PR1276 e YN-PR1277 possuem o encaixe YH-11.

10"

YN-PR1269

FIAT	ENCAIXE A
MODELOS	ANO
UNO (MODELO NOVO COM PALHETA CONVENCIONAL)	2011/2014
UNO (MODELO NOVO COM PALHETA CONVENCIONAL)	2015

MITSUBISHI	ENCAIXE A
MODELOS	ANO
ASX	2011/2017

SUZUKI	ENCAIXE A
MODELOS	ANO
SX4	2008/2016

HONDA	ENCAIXE A
MODELOS	ANO
HRV (PALHETA CONVENCIONAL)	2015/2021
HRV (PALHETA SLIM BLADE)	2018/2021

11"

YN-PR1270
YN-PR1276

CHEVROLET	ENCAIXE A
MODELOS	ANO
SPIN	2012
CRUZE/CRUZE SPORT (MODELO NOVO)	2017/2017

CITROEN	ENCAIXE A
MODELOS	ANO
DS3	2012/2017

FORD	ENCAIXE A
MODELOS	ANO
SÉRIE F (TODOS)	2017/2021

FIAT	ENCAIXE A
MODELOS	ANO
MOBI	2016

PEUGEOT	ENCAIXE A
MODELOS	ANO
208	2019/2021
2008	2020/2021

HYUNDAI	ENCAIXE A
MODELOS	ANO
HB20/HB20X	2013/2019
CRETA	2012

KIA	ENCAIXE A
MODELOS	ANO
SPORTAGE IV	2017/2021
SORENTO	2009/2016
SOUL	2009/2014

FORD	ENCAIXE A
MODELOS	ANO
NEW FIESTA HATCH	2010

MERCEDEZ-BENS	ENCAIXE A
MODELOS	ANO
CLASSE B	2005/2011

MITSUBISHI	ENCAIXE A
MODELOS	ANO
PAJERO SPORT	2018/2021

RENAULT	ENCAIXE A
MODELOS	ANO
CLIO II	1999/2005
CLIO II	2006/2017

SUZUKI	ENCAIXE A
MODELOS	ANO
SWIFT SPORT	2014/2017
VITARA (MODELO NOVO)	2017/2021
S CROSS	2014

11"

YN-PR1270
YN-PR1276

TOYOTA	ENCAIXE A
MODELOS	ANO
RAV	2000/2005

VOLKSWAGEN	ENCAIXE A
MODELOS	ANO
GOLF GVII/GOLF GVII VARIANT	2014/2018

12"

YN-PR1271
YN-PR1277

BMW	ENCAIXE A
MODELOS	ANO
X5	2013

CHERY	ENCAIXE A
MODELOS	ANO
FACE	2010/2015

CHEVROLET	ENCAIXE A
MODELOS	ANO
CELTA	2004/2015
VECTRA GTX	2012/2017

CITROEN	ENCAIXE A
MODELOS	ANO
C3 (MODELO NOVO)	****

DODGE	ENCAIXE A
MODELOS	ANO
JORNEY	2008

FIAT	ENCAIXE A
MODELOS	ANO
BRAVO	2011/2016
PUNTO	2008/2019
500 MEXICANO	2012/2017
FREEMONT	2011/2018
500 POLONES	2009/2011

FORD	ENCAIXE A
MODELOS	ANO
ECOSPORT	2005/2012
FIESTA II	2005/2011
FIESTA II	2011/2014
FOCUS HATCH II	2008/2013

HONDA	ENCAIXE A
MODELOS	ANO
CR-V	2013/2017

HYUNDAI	ENCAIXE A
MODELOS	ANO
I30/I30 CW	2007/2012
I30	2013/2016
I30/I30 CW (MODELO ANTIGO PALHETA CONVENCIONAL)	2008/2012
I30/I30 CW (MODELO ANTIGO SLIM BLADE)	2008/2012

KIA	ENCAIXE A
MODELOS	ANO
PICANTO (MODELO NOVO)	2011/2018
SPORTAGE III	2011/2016

MERCEDEZ-BENS	ENCAIXE A
MODELOS	ANO
CLASSE B	2005/2011

MITSUBISHI	ENCAIXE A
MODELOS	ANO
PAJERO FULL	1998/2006
PAJERO FULL	2009
OUTLANDER	2014
PAJERO DAKAR/PAJERO HPE	2010
OUTLANDER	2007/2013
PAJERO	2009

13"

YN-PR1272
YN-PR1278

CHERY	ENCAIXE A
MODELOS	ANO
TIGGO	2009/2016
CELER	2013

CHEVROLET	ENCAIXE A
MODELOS	ANO
BLAZER	1996/2012

FIAT	ENCAIXE A
MODELOS	ANO
TEMPRA	1992/1999
TEMPRA/SW	1992/1999
TIPO	1994/1997
UNO/MILLE (MODELO ANTIGO)	1984/1994
UNO/MILLE (MODELO ANTIGO)	1995/2013

KIA	ENCAIXE A
MODELOS	ANO
SORENTO	2003/2009

VOLKSWAGEN	ENCAIXE A
MODELOS	ANO
GOLF GIV	1999/2006

14"

YN-PR1273
YN-PR1279

CHEVROLET	ENCAIXE A
MODELOS	ANO
ASTRA	1999/2011

CITROEN	ENCAIXE A
MODELOS	ANO
BERLINGO	****
C3	****
C3 XTR (MODELO ANTIGO)	****
C3/C3 XTR (MODELO ANTIGO)	****

FORD	ENCAIXE A
MODELOS	ANO
EDGE	2008/2014
FOCUS HATCH III (MODELO NOVO)	2014

HONDA	ENCAIXE A
MODELOS	ANO
FIT	2003/2008
FIT	2015/2017
FIT	2009/2014

HYUNDAI	ENCAIXE A
MODELOS	ANO
NEW SANTA FÉ	2018/2021
SANTA FÉ	2001/2006
SANTA FÉ	2013/2017
SANTA FÉ	2007/2012
TUCSON (MODELO NOVO)	2018/2021
VERACRUZ	2008/2012

JAC	ENCAIXE A
MODELOS	ANO
J3	2011/2017
T8	2013

KIA	ENCAIXE A
MODELOS	ANO
MOHAVE	2009/2017

LAND ROVER	ENCAIXE A
MODELOS	ANO
FREELANDER	1997/2006

MITSUBISHI	ENCAIXE A
MODELOS	ANO
AIRTREK	2003/2007

14"

YN-PR1273
YN-PR1279

NISSAN	ENCAIXE A
MODELOS	ANO
TIIDA	2008/2013

PEUGEOT	ENCAIXE A
MODELOS	ANO
206	1998/2009
206 CC	2001/2008
206 SW	2005/2008
207 SW	2008/2014
207	2008/2015
208	2012/2018
208	2019/2021

RENAULT	ENCAIXE A
MODELOS	ANO
KANGOO/EXPRESS	1998/2018

SSANGYONG	ENCAIXE A
MODELOS	ANO
KORANDO (MODELO NOVO)	2011

SUBARU	ENCAIXE A
MODELOS	ANO
IMPREZA/IMPREZA WAGON	1993/2000
OUTBACK	2003/2009
IMPREZA/WAGON	2008/2015
FORESTER	1997/2007
FORESTER	2008/2009

TOYOTA	ENCAIXE A
MODELOS	ANO
YAIRIS/YARIS SEDAN	2018/2021

TOYOTA	ENCAIXE A
MODELOS	ANO
YAIRIS/YARIS SEDAN	2018/2021

TOYOTA	ENCAIXE A
MODELOS	ANO
YAIRIS/YARIS SEDAN	2018/2021

TOYOTA	ENCAIXE A
MODELOS	ANO
YAIRIS/YARIS SEDAN	2018/2021

TOYOTA	ENCAIXE A
MODELOS	ANO
YAIRIS/YARIS SEDAN	2018/2021

VOLKSWAGEN	ENCAIXE A
MODELOS	ANO
PARATI II	1996/1999
PARATI III	1999/2003
PARATI I	1982/1996

VOLKSWAGEN	ENCAIXE A
MODELOS	ANO
PARATI II	1996/1999
PARATI III	1999/2003
PARATI I	1982/1996

VOLKSWAGEN	ENCAIXE A
MODELOS	ANO
PARATI II	1996/1999
PARATI III	1999/2003
PARATI I	1982/1996

VOLKSWAGEN	ENCAIXE A
MODELOS	ANO
PARATI II	1996/1999
PARATI III	1999/2003
PARATI I	1982/1996

VOLKSWAGEN	ENCAIXE A
MODELOS	ANO
PARATI II	1996/1999
PARATI III	1999/2003
PARATI I	1982/1996

VOLKSWAGEN	ENCAIXE A
MODELOS	ANO
PARATI II	1996/1999
PARATI III	1999/2003
PARATI I	1982/1996

CHRYSLER	ENCAIXE A
MODELOS	ANO
PT CRUISER	2000/2010

CITROEN	ENCAIXE A
MODELOS	ANO
XSARA PICASSO	****

FORD	ENCAIXE A
MODELOS	ANO
FOCUS HATCH I	2000/2010

15"

YN-PR1274
YN-PR1280

KIA

MODELOS	ENCAIXE A
	ANO
BESTA	1993/1997

MITSUBISHI

MODELOS	ENCAIXE A
	ANO
PAJERO	1990/2001
PAJERO/PAJERO CLASSIC	1991/2000

RENAULT

MODELOS	ENCAIXE A
	ANO
SCENIC	1997/2010

TOYOTA

MODELOS	ENCAIXE A
	ANO
PRIUS	2013/2015

VOLKSWAGEN

MODELOS	ENCAIXE A
	ANO
GOL GII	1995/1999
GOL GII SPECIAL	1998/2001
GOL GII SPECIAL	2001/2005

16"

YN-PR1275
YN-PR1281

FORD

MODELOS	ENCAIXE A
	ANO
ESCORT	1996/2002
EXPLORER	1991/2005

HYUNDAI

MODELOS	ENCAIXE A
	ANO
TERRACAN	2001/2007

LAND ROVER

MODELOS	ENCAIXE A
	ANO
RANGE ROVER IV	2013

LAND ROVER

MODELOS	ENCAIXE A
	ANO
PAJERO SPORT	1998/2006
PAJERO TR4	2002/2009

NISSAN

MODELOS	ENCAIXE A
	ANO
X-TERRA	2003/2008

**SOLUÇÃO PARA
A MAIORIA
DOS VEÍCULOS
NACIONAIS E
IMPORTADOS!**



CINOY
PRODUTOS AUTOMOTIVOS



10" - 16" PALHETAS TRASEIRA CARENADA



Design simplificado
produzida em material
de qualidade excelente!



PALHETAS TRASEIRA CARENADA

YN-PSTC10

CONEXÃO **K**

MARCA	MODELO	ANO	POLEGADAS TRÁS
	KA HATCH G3 KA SEDAN G3	2014; 2014;	10"
	CROSSFOX FOX GOL G5 GOL G6 GOL G7	2010/2024 2010/2012 2008/2012 2012/2016 2016;	

YN-PSTC12

CONEXÃO **K**

MARCA	MODELO	ANO	POLEGADAS TRÁS
	JOURNEY	2008;	12"
	FREEMONT	2011;	
	ETIOS HILUX G3 HILUX SW4	2012; 2015; 2015;	

YN-PSTC14

CONEXÃO **K**

MARCA	MODELO	ANO	POLEGADAS TRÁS
	DOBLÔ PALIO FASE 1 G1 STILO	2008;	14"
	J3 J3 TURIN	2012; 2015; 2015;	
	PAJERO TR4	2012; 2015; 2015;	
	GOL G4 PARATI G3 PARATI G4 SPACECROSS SPACEFOX	2005/2013 2003/2005 2005/2012 2006/2024 2006/2024	

YN-PSTC15

CONEXÃO **K**

MARCA	MODELO	ANO	POLEGADAS TRÁS
	CELTA G1 CELTA G2 CORSA HATCH G2 MERIVA	2004; 2004; 2002/2012 2004/2012	15"
	PALIO ADVENTURE PALIO FASE 2 G1 PALIO FASE 3 G1 PALIO WEEKEND FASE G1	2001/2004 2004; 2008/2012 2001/2004	
	KA G1	1997/2008	
	SANDERO G1	2008/2013	



YN-PSTC16

CONEXÃO **K**

MARCA	MODELO	ANO	POLEGADAS TRÁS
	FIESTA FIESTA G1	1996/2006 1996/2006	16"

YN-PSTC16

CONEXÃO **K**

MARCA	MODELO	ANO	POLEGADAS TRÁS.
	IDEA ADVENTURE FASE 1 G1	2011/2024	16"
	IDEA ADVENTURE G1	2005/2010	
	IDEA FASE 1 G1	2011/2024	
	IDEA G1	2004/2010	
	PALIO ADVENTURE	2005/2008	
	PALIO WEEKEND	2005/2008	
	KICKS	2016.	
	GOL G3	1999/2005	

MATERIAL DE APOIO

EXPOSITOR PARA PALHETAS

YN-DSP002



**FÁCIL
INSTALAÇÃO**

**0%
DANIFICAÇÃO**



- DESMONTÁVEL
- EM METAL
- LEVE E RESISTENTE
- 16 GANCHOS EXPOSITORES
CAPACIDADE PARA
80 PRODUTOS
- MEDIDAS:
120x59x24CM (AxLxP)

CINOY
PRODUTOS AUTOMOTIVOS



AMORTECEDORES DE PORTA-MALAS

DE PORTA-MALAS

CONECTORES DOS AMORTECEDORES

Amortecedores de linha leve, para porta-malas.

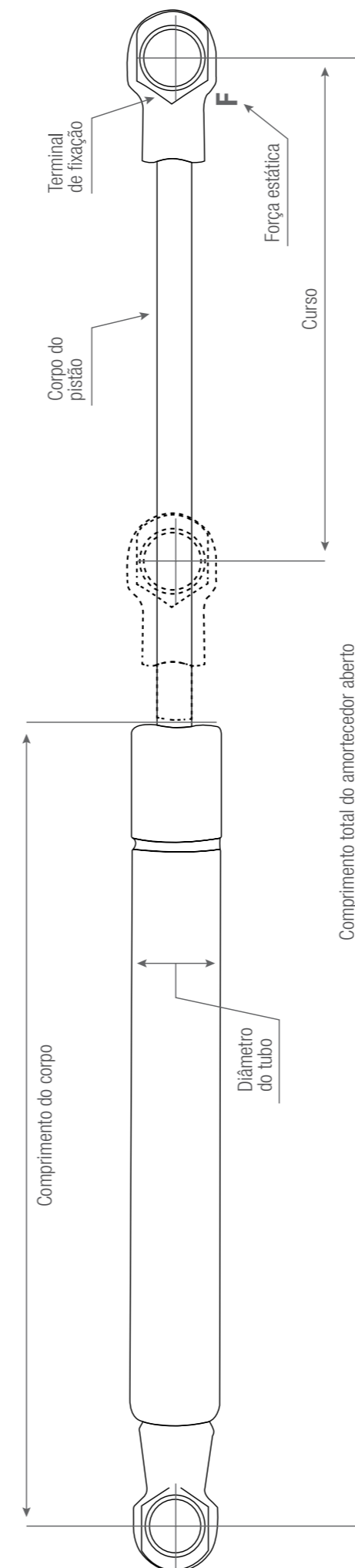

SOBRE AMORTECEDORES:

Os produtos mencionados neste catálogo, são fabricados com altíssima qualidade e servem para substituir as peças originais do veículo. O uso das marcas das montadoras, nomes de veículos e as devidas imagen, servem como determinantes para quais aplicações/montagens e uso. O registro e propriedade originais pertencem aos respectivos fabricantes.

O QUE SÃO:

nada mais que uma mola a gás, um dispositivo monotubular pressurizado cujo o pistão se encontra permanentemente submetido a uma pressão imposta por um gás existente dentro do tubo de pressão.



















CÓDIGO	MODELO	VEÍCULO	ANO	CONEXÃO
YN-AMIM1970		A3	2004-2006	
YN-AMIM1955	 	C3 G2 Ka G2	2012> 2008-2014	
YN-AM1136		PICASSO	1999-2004	
YN-AMIM001		C3	2003>	
YN-AMIM006		PICASSO	2001-2005 2012-2008	
YN-AM1128		MAREA SW	1996-2007	
YN-AM1129		MALAS LINEA	2009>	
YN-AMFT001		UNO	1984-2010	
YN-AMFT002		TIPO	1988-1995	
YN-AMFT003		STILO	2001>	
YN-AMFT004		NOVO UNO	2010>	
YN-AMFT005		IDEA	2012-2005 2012-2018	
YN-AMFT006		PALIO	1996-2005 s/limpador	
YN-AMFT007		PALIO WEEKEND	1996-2007	

CÓDIGO	MODELO	VEÍCULO	ANO	CONEXÃO
YN-AMFT009		ELBA	1984>	
YN-AMFT010		PALIO G2	2011>	
YN-AMFT011		PUNTO	2008>	
YN-AMFT012		DOBLÔ	2001>	
YN-AMFT013		PALIO WEEKEND G1 FII/FIII	2004> tampa traseira	
YN-AMFT014		PALIO	1996-2005 c/ limpador	
YN-AMFT1941		IDEA G1 FASE I	2010>	
YN-AMFT1945		GRAND SIENA	2014>	
YN-AMFT1973		MOBI	2016>	
YN-AM1130			FOCUS HATCH	2002-2008
YN-AM1131	ESCORT SW		1997-2003	
YN-AM1132	BELINA		1968-1989	
YN-AMFD001	ESCORT		1984-1992	
YN-AMFD002	Ka		1997-2001	

CÓDIGO	MODELO	VEÍCULO	ANO	CONEXÃO
YN-AMFD003		FIESTA HATCH	1996-2003	
YN-AMFD004		ECOSPORT	2003	
YN-AMFD005		ESCORT	1993-1996	
YN-AMFD006		FUSION	2006>	
YN-AMFD007		Ka	2002-2007	
YN-AMFD010		Ka	2008>	
YN-AMFD011		FIESTA	2003>	
YN-AMFD1949		FOCUS HATCH GII	2008-2013	
YN-AMFD1950		FOCUS SEDAN GII	2008-2013	
YN-AMFD1951		FOCUS HATCH GIII	2013>	
YN-AMFD1952		Ka SEDAN GIII	2014>	
YN-AMFD1958		FIESTA SEDAN GII	2002-2014>	
YN-AMFD1964		FIESTA HATCH GIII	2010>	
YN-AMFD1965	FUSION GI	2009-2012>		

CÓDIGO	MODELO	VEÍCULO	ANO	CONEXÃO
YN-AMFD1974		F-250 CAPO	1998>	
YN-AMGM001		CORSA HATCH 5 PORTAS/ WAGON	1994-2001	
YN-AMGM002		CORSA HATCH 3 PORTAS	1994-2001	
YN-AMGM003		CELTA CORSA HATCH	2000> 2002>	
YN-AMGM004		ASTRA	1998>	
YN-AMGM005		ZAFIRA	2001>	
YN-AMGM006		KADETT GSI	1989>	
YN-AMGM007		VECTRA	2005>	
YN-AMGM008		MERIVA	2002>	
YN-AMGM009		BLAZER	1995-2013	
YN-AMGM010		AGILE	2009>	
YN-AMGM011		S10 BLAZER CAPO	2001>	
YN-AMGM012		VECTRA CAPO	2005>	
YN-AMGM014		IPANEMA TAMPA TRASEIRA COM LIMPADOR	1989-1998	

CÓDIGO	MODELO	VEÍCULO	ANO	CONEXÃO
YN-AMGM015		CAPTIVA CAPO	2010-2012>	
YN-AMGM016		CAPTIVA TAMPA TRASEIRA	2008>	
YN-AMGM017		ONIX TAMPA	2012>	
YN-AMGM018		SPIN	2006-2012>	
YN-AMGM1943		MONZA HATCH 1.8	1983-1987>	
YN-AMGM1947		TRACKER GII	2013>	
YN-AMGM1956		TRAILBLAZER	2012>	
YN-AMGM1966		VECTRA SEDAN GIII	2005-2012>	
YN-AMGM1969		CRUZE HATCH GI	2012-2016>	
YN-AMIM007		FIT	2003-2008	
YN-AMIM1948		FIT GIII	2014>	
YN-AMIM1954		FIT GII	2008-2014>	
YN-AMIM1962		CR-V GIII	2007-2012>	

CÓDIGO	MODELO	VEÍCULO	ANO	CONEXÃO
YN-AMIM009		TUCSON	2006-2016	
YN-AMIM010		HB20 HATCH	2007-2012>	
YN-AMIM1959		TUCSON TAMPA TRASEIRA	2005-2016	
YN-AMIM1971		IX35	2010>	
YN-AMIM1972		SANTA FÉ GII	2006-2013>	
YN-AMIM1961		SPORTAGE GI	1995-2001	
YN-AMIM1942		PAJERO TR4	2003>	
YN-AMIM1957		PAJERO SPORT	2006>	
YN-AMIM1944		KICKS	2016>	
YN-AMIM1960		SENTRA	2008>	
YN-AM1138		206/207 SW	TODOS	
YN-AMIM002		206	1999-2010	
YN-AMIM011		307	2002>	

CÓDIGO	MODELO	VEÍCULO	ANO	CONEXÃO	
YN-AM1139		MEGANE	<2004		
YN-AM1140		MEGANE SEDAN	2006>		
YN-AMIM003		CLIO HATCH	2000>		
YN-AMIM004		SCENIC	1999>		
YN-AMIM005		KANGOO	1998>		
YN-AMIM008		SANDERO SEM LIMPADOR TRASEIRO	2008>		
YN-AMIM012		KANGOO	1998>		
YN-AMIM013		DUSTER CAPO	2004-2010>		
YN-AMIM014		DUSTER TAMPA TRASEIRA	2004-2010>		
YN-AMIM015		SANDERO COM LIMPADOR TRASEIRO	2008>		
YN-AMIM016		SCENIC TAMPA TRASEIRA	2001>		
YN-AMIM1967		LOGAN GII CAPO	2013>		
YN-AMIM1946		 	i30 GI DUSTER OROCH NOVO	2009-2013> 2011> 2015>	

CÓDIGO	MODELO	VEÍCULO	ANO	CONEXÃO
YN-AM1137		FIELDER	TODOS	
YN-AMIM1953		HILUX SW4 GIII	2016>	
YN-AMIM1968		HILUX SW4 GII	2005-2016>	
YN-AM1133		PARATI PASSAT KOMBI	1984-1995 1974-1989 1975-2000	
YN-AM1134		UP	TODOS	
YN-AM1135		BORA	1998>	
YN-AMVW001		GOL GI 1.6 GTS/GTI	1980-1994>	
YN-AMVW002		GOL GII COM LIMPADOR	1995-1999>	
YN-AMVW003		GOL GIII/GIV COM LIMPADOR	2000-2007>	
YN-AMVW004		GOL GV	2008>	
YN-AMVW005		QUANTUM	1991>	
YN-AMVW006		POLO SEDAN	2001>	
YN-AMVW007		PARATI GII/GIII/GIV	1995>	
YN-AMVW008		FOX CROSSFOX	2003>	



CÓDIGO	MODELO	VEÍCULO	ANO	CONEXÃO
YN-AMVW009		GOLF AUDI A3	1999-2006>	
YN-AMVW010		KOMBI	1997	
YN-AMVW011		KOMBI	1957-1996>	
YN-AMVW012		POLO HATCH	2001>	

CÓDIGO	MODELO	VEÍCULO	ANO	CONEXÃO
YN-AMVW013		SPACEFOX	2012>	
YN-AMVW1963		SAVEIRO GV/GVI/GVII NOVO	2009>	
YN-AMVW1975		GOLF GVII CAPO	2013>	





INTERRUPTORES

INTERRUPTORES E MOLDURAS

E MOLDURAS



YN-KG0732
VIDRO ELÉTRICO

APLICAÇÃO	ANO	SIMPLES
UNO	84/04	D.E./D.D./T.E./T.D.
PRÊMIO	85/95	LED VERDE ●
ELBA	85/96	5 PINOS
FIORINO	85/04	

YN-KG0733
VIDRO ELÉTRICO

APLICAÇÃO	ANO	DUPLO
UNO	84/04	D.E.
PRÊMIO	85/95	LED VERDE ●
ELBA	85/96	6 PINOS
FIORINO	85/04	

YN-KG1644
VIDRO ELÉTRICO

APLICAÇÃO	ANO	SIMPLES
PALIO	01>	D.D.
WEEKEND	01>	LED VERMELHO ●
SIENA	01>	5 PINOS
STRADA	01>	

YN-KG1645
VIDRO ELÉTRICO

APLICAÇÃO	ANO	SIMPLES
PALIO	01>	D.E./L.E.
WEEKEND	01>	LED VERDE ●
SIENA	01>	6 PINOS
STRADA	01>	

YN-KG1646
VIDRO ELÉTRICO

APLICAÇÃO	ANO	DUPLO
PALIO	01/03	D.E.
WEEKEND	01/04	LED VERMELHO ●
SIENA	01/04	6 PINOS
STRADA	01>	

YN-KG0734
VIDRO ELÉTRICO

APLICAÇÃO	ANO	DUPLO
UNO	02/13	D.E.
FIORINO	02/15	LED VERMELHO ●
		6 PINOS

YN-KG0735
VIDRO ELÉTRICO

APLICAÇÃO	ANO	SIMPLES
PALIO	96/07	D.D.
WEEKEND	96/07	LED VERDE ●
SIENA	96/07	5 PINOS
STRADA	96>	

YN-KG0736
VIDRO ELÉTRICO

APLICAÇÃO	ANO	DUPLO
PALIO	96/00	D.E.
WEEKEND	97/00	LED VERDE ●
SIENA	97/00	6 PINOS
STRADA	96>	

YN-KG1647
VIDRO ELÉTRICO

APLICAÇÃO	ANO	SIMPLES
PALIO	03>	T.E.
SIENA	03>	LED VERMELHO ●
		4 PINOS

YN-KG1648
VIDRO ELÉTRICO

APLICAÇÃO	ANO	SIMPLES
GRAND SIENA	12/15	T.E.
		LED VERMELHO ●
		4 PINOS

YN-KG1649
VIDRO ELÉTRICO

APLICAÇÃO	ANO	SIMPLES
GRAND SIENA	12/15	T.D.
		LED VERMELHO ●
		4 PINOS

YN-KG0737
VIDRO ELÉTRICO

APLICAÇÃO	ANO	DUPLO
PALIO	01/03	D.E.
WEEKEND	01/04	LED VERMELHO ●
SIENA	01/04	6 PINOS
STRADA	01>	

YN-KG0738
VIDRO ELÉTRICO

APLICAÇÃO	ANO	SIMPLES
PALIO FIRE	01/15	D.D.
WEEKEND	01/15	LED VERMELHO ●
STRADA	01/15	6 PINOS
SIENA	01/15	

YN-KG0739
VIDRO ELÉTRICO

APLICAÇÃO	ANO	DUPLO
PALIO FIRE	01/15	D.E.
WEEKEND	01/15	LED VERMELHO ●
STRADA	01/15	12 PINOS
SIENA	01/15	

YN-KG1652
VIDRO ELÉTRICO

APLICAÇÃO	ANO	SIMPLES
NOVO UNO	10>	L.E.
		LED VERMELHO ●
		4 PINOS

YN-KG1653
VIDRO ELÉTRICO

APLICAÇÃO	ANO	SIMPLES
NOVO UNO	10>	L.D.
		LED VERMELHO ●
		4 PINOS

YN-KG1654
VIDRO ELÉTRICO

APLICAÇÃO	ANO	SIMPLES
IDEA	07/15	T.E.
		LED VERMELHO ●
		4 PINOS

YN-KG0740
VIDRO ELÉTRICO

APLICAÇÃO	ANO	DUPLO
PALIO	01/03	D.E.
WEEKEND	01/04	LED VERMELHO ●
SIENA	01/04	12 PINOS
STRADA	01>	

YN-KG0741
VIDRO ELÉTRICO

APLICAÇÃO	ANO	SIMPLES
PALIO	01/03	D.E./D.D.
WEEKEND	01/04	LED VERMELHO ●
SIENA	01/04	4 PINOS
STRADA	01>	

YN-KG0742
VIDRO ELÉTRICO

APLICAÇÃO	ANO	DUPLO
PALIO	03>	D.E.
STRADA	03>	LED VERMELHO ●
SIENA	03>	4 PINOS

YN-KG1655
VIDRO ELÉTRICO

APLICAÇÃO	ANO	DUPLO
IDEA	07/15	T.D.
		LED VERMELHO ●
		4 PINOS

YN-KG1656
VIDRO ELÉTRICO

APLICAÇÃO	ANO	DUPLO
PALIO	12>	D.E.
		LED VERMELHO ●
		4 PINOS

YN-KG1657
VIDRO ELÉTRICO

APLICAÇÃO	ANO	SIMPLES
PALIO	12>	D.D.
		LED VERMELHO ●
		4 PINOS

YN-KG1658

VIDRO ELÉTRICO

APLICAÇÃO
GRAND SIENA
PALIO

ANO
12/15
12/15

QUÁDRUPLO
D.E.
LED VERMELHO ●
8 PINOS



YN-KG1659

VIDRO ELÉTRICO

APLICAÇÃO
SIENA
PALIO

ANO
03>
03>

QUÁDRUPLO
D.E.
LED VERMELHO ●
8 PINOS



YN-KG1660

VIDRO ELÉTRICO

APLICAÇÃO
PUNTO
LINEA

ANO
07/12
09/14

QUÁDRUPLO
D.E.
LED VERMELHO ●
8 PINOS



YN-KG1784

VIDRO ELÉTRICO

APLICAÇÃO
UNO
FIORINO

ANO
02/13
02/15

SIMPLES
D.D.
LED VERMELHO ●
5 PINOS



YN-KG1864

VIDRO ELÉTRICO

APLICAÇÃO
UNO
MOBI
ARGO
PUNTO
CRONOS
STRADA

ANO
15>
16>
17>
17>
18>
21>

SIMPLES
D.D. / T.E. / T.D.
LED BRANCO ○
4 PINOS



YN-KG1865

VIDRO ELÉTRICO

APLICAÇÃO
UNO
MOBI
ARGO
PUNTO
CRONOS
STRADA

ANO
15>
16>
17>
17>
18>
21>

DUPLO
D.E.
LED BRANCO ○
4 PINOS

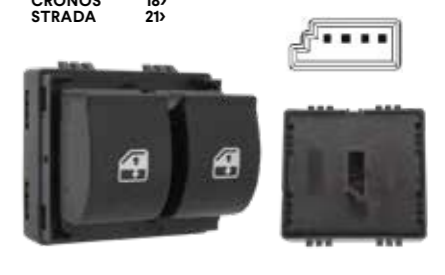

YN-KG1661

VIDRO ELÉTRICO

APLICAÇÃO
PUNTO
LINEA

ANO
07/12
09/14

QUÁDRUPLO
D.E.
LED VERMELHO ●
8 PINOS



YN-KG1662

VIDRO ELÉTRICO

APLICAÇÃO
PUNTO

ANO
13/17

SIMPLES
D.E.
LED VERMELHO ●
4 PINOS



YN-KG1663

VIDRO ELÉTRICO

APLICAÇÃO
PUNTO
UNO

ANO
12>
15>

QUÁDRUPLO
D.E.
LED VERMELHO ●
4 PINOS



YN-KG1866

VIDRO ELÉTRICO

APLICAÇÃO
PALIO
SIENA
STRADA
IDEA
PUNTO

ANO
03>
03/11
03/11
07/15
07/15

QUÁDRUPLO
D.E.
LED VERMELHO ●
8 PINOS



YN-KG1665

MOLDURA

APLICAÇÃO
PALIO
STRADA

ANO
96/01
96/01

L.E.
PORTA LATERAL



YN-KG1666

MOLDURA

APLICAÇÃO
PALIO
STRADA

ANO
96/01
96/01

L.D.
PORTA LATERAL



YN-KG1664

VIDRO ELÉTRICO

APLICAÇÃO
PUNTO
UNO

ANO
12>
15>

QUÁDRUPLO
D.E.
LED VERMELHO ●
8 PINOS



YN-KG1741

VIDRO ELÉTRICO

APLICAÇÃO
IDEA

ANO
07/15

DUPLO
D.E.
LED VERMELHO ●
12 PINOS



YN-KG1742

VIDRO ELÉTRICO

APLICAÇÃO
IDEA

ANO
07/15

QUÁDRUPLO
D.E.
LED VERMELHO ●
16 PINOS



YN-KG1667

MOLDURA

APLICAÇÃO
PALIO
STRADA FIRE

ANO
01>
01>

L.E.



YN-KG1668

MOLDURA

APLICAÇÃO
PALIO
STRADA FIRE

ANO
01>
01>

L.D.



YN-KG1743

VIDRO ELÉTRICO

APLICAÇÃO
IDEA

ANO
07/15

QUÁDRUPLO
D.E.
LED VERMELHO ●
8 PINOS



YN-KG1744

VIDRO ELÉTRICO

APLICAÇÃO
IDEA

ANO
07/15

SIMPLES
D.D.
LED VERMELHO ●
8 PINOS



YN-KG1746

VIDRO ELÉTRICO

APLICAÇÃO
PALIO
SIENA
WEEKEND
STRADA

ANO
01/03
01/04
01/04
01>

SIMPLES
D.D.
LED VERMELHO ●
5 PINOS



YN-KG0729

VIDRO ELÉTRICO

APLICAÇÃO
KA

ANO
08>

DUPLO
D.E.
LED VERDE ●
8 PINOS



YN-KG0730

VIDRO ELÉTRICO

APLICAÇÃO
ECOSPORT
RANGER
FIESTA AMAZON

ANO
03>
03>
03/14

DUPLO
D.D. / T.E. / T.D.
LED VERDE ●
6 PINOS



YN-KG0731

VIDRO ELÉTRICO

APLICAÇÃO
ECOSPORT
RANGER
FIESTA AMAZON

ANO
03>
03>
03/14

DUPLO
D.E.
LED VERDE ●
6 PINOS



YN-KG1180
VIDRO ELÉTRICO

APLICAÇÃO
ECOSPORT
RANGER
FIESTA AMAZON

ANO
03>
03>
03/14

QUÁDRUPLO
D.E.
LED VERDE ●
11 PINOS



YN-KG1181
VIDRO ELÉTRICO

APLICAÇÃO
KA

ANO
08>

SIMPLES
D.D.
LED VERDE ●
6 PINOS



YN-KG1669
VIDRO ELÉTRICO

APLICAÇÃO
ECOSPORT ZETEC

ANO
97/02

SIMPLES
D.E.
LED VERDE ●
12 PINOS



YN-KG1679
VIDRO ELÉTRICO

APLICAÇÃO
ESCORT

ANO
93/96

SIMPLES
CENTRAL
LED VERDE ●
5 PINOS



YN-KG1635
VIDRO ELÉTRICO

APLICAÇÃO
KA
FIESTA
FIESTA STREET
NOVO KA

ANO
97/07
08/14
08/14
08/14

DUPLO
D.E.
LED VERDE ●
8 PINOS



YN-KG1636
VIDRO ELÉTRICO

APLICAÇÃO
ESCORT
VERONA

ANO
90/92
90/92

DUPLO
D.E.
SEM LED
10 PINOS



YN-KG1670
VIDRO ELÉTRICO

APLICAÇÃO
FOCUS HATCH
FOCUS SEDAN

ANO
00/08
00/08

SIMPLES
D.D. / T.E. / T.D.
LED VERDE ●
6 PINOS



YN-KG1671
VIDRO ELÉTRICO

APLICAÇÃO
ESCORT ZETEC

ANO
97/02

QUÁDRUPLO
D.E.
LED VERDE ●
8 PINOS



YN-KG1672
VIDRO ELÉTRICO

APLICAÇÃO
FOCUS HATCH
FOCUS SEDAN

ANO
00/08
00/08

QUÁDRUPLO
D.E.
LED VERDE ●
8 PINOS



YN-KG1737
VIDRO ELÉTRICO

APLICAÇÃO
FOCUS HATCH
FOCUS SEDAN

ANO
00/08
00/08

SIMPLES
D.D. / T.E. / T.D.
LED VERDE ●
5 PINOS



YN-KG1740
VIDRO ELÉTRICO

APLICAÇÃO
MONDEO
FOCUS

ANO
97/01
00/08

QUÁDRUPLO
D.E.
LED VERDE ●
5 PINOS



YN-KG1673
VIDRO ELÉTRICO

APLICAÇÃO
KA
FIESTA

ANO
96/07
96/06

SIMPLES
L.E.
LED VERDE ●
6 PINOS



YN-KG1674
VIDRO ELÉTRICO

APLICAÇÃO
KA
FIESTA

ANO
96/07
96/06

SIMPLES C/MOSTRINA
L.E.
LED VERDE ●
6 PINOS



YN-KG1675
VIDRO ELÉTRICO

APLICAÇÃO
ESCORT
MONDEO

ANO
97/02
94/95

SIMPLES
T.E. / T.D.
LED VERDE ●
6 PINOS



YN-KGGM2084
VIDRO ELÉTRICO

APLICAÇÃO
COBALT
ONIX
PRISMA
SPIN

ANO
11/16
13>
13>
12/18

QUÁDRUPLO
D.E.



YN-KGGM2085
VIDRO ELÉTRICO

APLICAÇÃO
COBALT
ONIX
PRISMA
SPIN

ANO
11/16
13>
13>
12/18

DUPLO
D.E.



YN-KGGM2086
VIDRO ELÉTRICO

APLICAÇÃO
COBALT
ONIX
PRISMA
SPIN

ANO
11/16
13>
13>
12/18

SIMPLES
D.E.



YN-KG1676
VIDRO ELÉTRICO

APLICAÇÃO
ROYALE
VERSALLES

ANO
91>
91>

SIMPLES
D.D. / T.E. / T.D.
LED VERDE ●
6 PINOS



YN-KG1677
VIDRO ELÉTRICO

APLICAÇÃO
ROYALE
VERSALLES

ANO
91>
91>

DUPLO
D.E.
LED VERDE ●
6 PINOS



YN-KG1678
VIDRO ELÉTRICO

APLICAÇÃO
ESCORT
VERONA

ANO
90/92
90/92

SIMPLES
D.D.
SEM LED



YN-KGGM2087
VIDRO ELÉTRICO

APLICAÇÃO
COBALT
ONIX
PRISMA
SPIN

ANO
11/16
13>
13>
12/18

SIMPLES
T.E. / T.D.



YN-KGGM2088
VIDRO ELÉTRICO

APLICAÇÃO
COBALT
ONIX
PRISMA
SPIN

ANO
15>
15>
15>
15>

QUÁDRUPLO
D.E.
LED AZUL ●



YN-KGGM2089
VIDRO ELÉTRICO

APLICAÇÃO
COBALT
ONIX
PRISMA
SPIN

ANO
13/16
13>
13>
13/16

DUPLO
D.E.
LED AZUL ●



YN-KG0743

VIDRO ELÉTRICO

APLICAÇÃO	ANO
ASTRA	99/11
ZAFIRA	01/12
MERIVA	02/12
CORSA HATCH	02/15
CORSA SEDAN	02/15
MONTANA	03/10
CELTA	03/11
PRISMA	06/19

DUPLO
D.E.
LED AMBAR ●
8 PINOS



YN-KG0744

VIDRO ELÉTRICO

APLICAÇÃO	ANO
CORSA	94/02
CORSA SEDAN	94/02
CORSA WAGON	94/02
CORSA CLASSIC	94/02
CORSA PICKUP	94/02
CORSA WIND	94/02
CORSA CLASSIC	96/15

SIMPLES
D.E. / D.D. / T.E. / T.D.
LED AMBAR ●
6 PINOS



YN-KG0745

VIDRO ELÉTRICO

APLICAÇÃO	ANO
AGILE	09/15
MONTANA	11/15
CELTA	12/15

SIMPLES
D.D. / T.E. / T.D.
LED AZUL ●
6 PINOS



YN-KG1633

VIDRO ELÉTRICO

APLICAÇÃO	ANO
VERSAILLES	91
ROYALE	91

SIMPLES
D.D. / T.E. / T.D.
LED VERDE ●
5 PINOS



YN-KG1634

VIDRO ELÉTRICO

APLICAÇÃO	ANO
PRISMA	11/14
CELTA	12/16

SIMPLES
CENTRAL
LED AZUL ●
4 PINOS



YN-KG1635

VIDRO ELÉTRICO

APLICAÇÃO	ANO
CELTA	12/16

SIMPLES
CENTRAL
LED AZUL ●
4 PINOS



YN-KG0746

VIDRO ELÉTRICO

APLICAÇÃO	ANO
A-10	88/92
A-20	88/92
BONANZA	88/92
C-10	88/92
C-20	88/92
CARAVAN	88/92
D-20	88/92
KADETTT	88/92
MONZA	88/92
OPALA	89/94

SIMPLES
D.E. / D.D. / T.E. / T.D.
LED VERDE ●
6 PINOS



YN-KG0747

VIDRO ELÉTRICO

APLICAÇÃO	ANO
CELTA	00/06

SIMPLES
L.E. / L.D.
LED AMBAR ●
6 PINOS



YN-KG1182

VIDRO ELÉTRICO

APLICAÇÃO	ANO
ASTRA	99/11
ZAFIRA	01/12
MERIVA	02/12
CORSA HATCH	02/15
CORSA SEDAN	02/15
CELTA	03/11
MONTANA	03/10
PRISMA	06/19

SIMPLES
D.D. / T.E. / T.D.
LED AMBAR ●
4 PINOS



YN-KG1636

VIDRO ELÉTRICO

APLICAÇÃO	ANO
VECTRA	05/11

QUÁDRUPLO
D.E.
LED AMBAR ●
18 PINOS



YN-KG1637

VIDRO ELÉTRICO

APLICAÇÃO	ANO
S10	12/16
TRAILBLAZER	13/14

DUPLO
D.E.
LED AZUL ●
18 PINOS



YN-KG1638

VIDRO ELÉTRICO

APLICAÇÃO	ANO
S10	12/16
TRAILBLAZER	13/14

QUÁDRUPLO
D.E.
LED AZUL ●
18 PINOS



YN-KG1627

VIDRO ELÉTRICO

APLICAÇÃO	ANO
CELTA	12/16
PRISMA	11/14

SIMPLES
CENTRAL
LED AZUL ●
4 PINOS

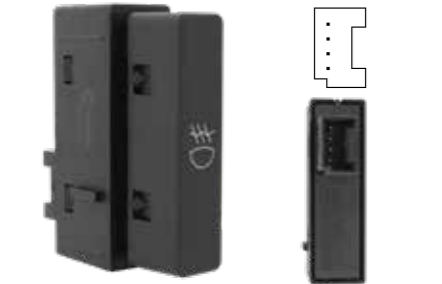

YN-KG1628

VIDRO ELÉTRICO

APLICAÇÃO	ANO
AGILE	09/15
MONTANA	11/15

SIMPLES
CENTRAL
LED AZUL ●
4 PINOS



YN-KG1629

VIDRO ELÉTRICO

APLICAÇÃO	ANO
AGILE	09/15
CELTA	12/15

QUÁDRUPLO
D.E.
LED AZUL ●
12 PINOS



YN-KG1639

VIDRO ELÉTRICO

APLICAÇÃO	ANO
S10	12/16
TRAILBLAZER	13/14

SIMPLES
T.E. / T.D.
4 PINOS



YN-KG1640

VIDRO ELÉTRICO

APLICAÇÃO	ANO
AGILE	09/11
CRUZE	11/13
SPIN	11/13
COBALT	11/15
MONTANA	11/15
ONIX	11/15
S-10	12/15
SONIC	12/15

SIMPLES
CENTRAL
LED AZUL ●
12 PINOS

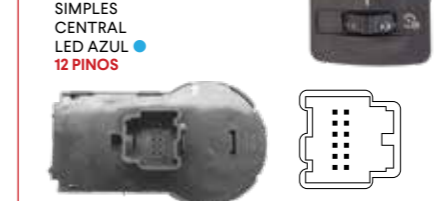

YN-KG1641

VIDRO ELÉTRICO

APLICAÇÃO	ANO
AGILE	09/11
SPIN	11/13
COBALT	11/15
MONTANA	11/15
ONIX	11/15
S-10	12/15
SONIC	12/15

SIMPLES
CENTRAL
LED AZUL ●
9 PINOS



YN-KG1630

VIDRO ELÉTRICO

APLICAÇÃO	ANO
ASTRA	99/11
ZAFIRA	01/12
MERIVA	02/12
CORSA HATCH	02/15
CORSA SEDAN	02/15
MONTANA	03/10
CELTA	03/11
PRISMA	06/19

QUÁDRUPLO
D.E.
LED AMBAR ●
12 PINOS



YN-KG1631

VIDRO ELÉTRICO

APLICAÇÃO	ANO
KADETT	94/98
IPANEMA	94/98
CORSA CLASSIC	96/15

DUPLO
D.E.
LED AMBAR ●
6 PINOS



YN-KG1632

VIDRO ELÉTRICO

APLICAÇÃO	ANO
A-10	88/92
A-20	88/92
BONANZA	88/92
C-10	88/92
C-20	88/92
CARAVAN	88/92
D-20	88/92
KADETTT	88/92
MONZA	88/92
OPALA	89/94

SIMPLES
D.E. / D.D. / T.E. / T.D.
LED VERDE ●
5 PINOS



YN-KG1731

VIDRO ELÉTRICO

APLICAÇÃO	ANO
CELTA	00/11
PRISMA	06/11

SIMPLES
CENTRAL
LED AMBAR ●
3 PINOS



YN-KG1732

VIDRO ELÉTRICO

APLICAÇÃO	ANO
CLASSIC	00/02
CORSA	00/02
HATCH	00/02
SEDAN	00/02
WAGON	00/02

SIMPLES
CENTRAL
LED AMBAR ●
4 PINOS



YN-KG1733

VIDRO ELÉTRICO

APLICAÇÃO	ANO
CORSA PICK-UP	94/01
CORSA SEDAN	94/01
CORSA	94/02
CORSA HATCH	94/02
WAGON	94/02
WIND	94/02
CLASSIC	96/15

SIMPLES
CENTRAL
LED AMBAR ●
4 PINOS



YN-KG1745

VIDRO ELÉTRICO

APLICAÇÃO
AGILE
CELTA
MONTANA

ANO
09/15
12/15
11/15

SIMPLES
D.E. / T.E. / T.D.
LED AZUL ●
4 PINOS



YN-KG0748

VIDRO ELÉTRICO

APLICAÇÃO
GOL SPECIAL G2
GOL G2
PARATI G2
SAVEIRO G2

ANO
01/96
96/99
96/99
96/99

SIMPLES
CENTRAL
LED VERDE ●
5 PINOS



YN-KG1682

VIDRO ELÉTRICO

APLICAÇÃO
CROSSFOX
FOX
GOL G4
POLO
SPACEFOX
UP

ANO
05/10
03/10
06/14
02/14
06/10
13/15

SIMPLES
T.E.
4 PINOS



YN-KG1683

VIDRO ELÉTRICO

APLICAÇÃO
CROSSFOX
FOX
SPACEFOX

ANO
03/09
03/09
03/09

SIMPLES
D.E.
4 PINOS



YN-KG1684

VIDRO ELÉTRICO

APLICAÇÃO
CROSSFOX
FOX
SPACEFOX

ANO
10/14
10/14
10/14

SIMPLES
D.E.
4 PINOS



YN-KG0750

VIDRO ELÉTRICO

APLICAÇÃO
CROSSFOX
FOX
GOL G4
GOL G5
GOL G6
PARATI G4
POLO
SAVEIRO G4
SAVEIRO G5
SAVEIRO G6
SPACEFOX

ANO
05/18
03/03
06/06
06/06
06/06
06/13
03/14
10/10
10/10
10/10
06/19

SIMPLES
D.D. / T.E. / T.D.
LED VERMELHO ●
4 PINOS



YN-KG0751

VIDRO ELÉTRICO

APLICAÇÃO
CROSSFOX
FOX
GOL G4
GOL G5
GOL G6
PARATI G4
POLO
SAVEIRO G4
SAVEIRO G5
SAVEIRO G6
SPACEFOX

ANO
05/18
03/03
06/06
06/06
06/06
06/13
03/14
10/10
10/10
10/10
06/19

DUPLO
D.E.
LED VERMELHO ●
4 PINOS



YN-KG0752

VIDRO ELÉTRICO

APLICAÇÃO
SANTANA
QUANTUM
GOL
VOYAGE
SAVEIRO
PARATI

ANO
84/91
87/92
87/96
87/96
87/96
87/96

SIMPLES
CENTRAL
LED VERDE ●
6 PINOS



YN-KG1685

VIDRO ELÉTRICO

APLICAÇÃO
CROSSFOX
FOX
SPACEFOX

ANO
10/14
10/14
10/14

SIMPLES
D.E.
6 PINOS



YN-KG1686

VIDRO ELÉTRICO

APLICAÇÃO
FOX
SPACEFOX
CROSSFOX
POLO

ANO
03/09
03/09
03/09
02/14

SIMPLES
D.E.
6 PINOS



YN-KG1687

VIDRO ELÉTRICO

APLICAÇÃO
GOL G2
PARATI G2
QUANTUM
SANTANA
SAVEIRO G2

ANO
96/99
96/99
95/98
95/98
96/99

DUPLO
D.E. / D.D.
LED VERMELHO ●
10 PINOS



YN-KG0753

VIDRO ELÉTRICO

APLICAÇÃO
CONSTALLATION

ANO
07/07

DUPLO
D.E.
LED VERMELHO ●
4 PINOS



YN-KG0754

VIDRO ELÉTRICO

APLICAÇÃO
CONSTALLATION

ANO
07/07

SIMPLES
D.D. / T.E. / T.D.
LED VERMELHO ●
4 PINOS



YN-KG0755

VIDRO ELÉTRICO

APLICAÇÃO
CONSTALLATION

ANO
07/07

SIMPLES
D.E.
LED VERDE ●
10 PINOS



YN-KG1689

VIDRO ELÉTRICO

APLICAÇÃO
GOL G3
PARATI G3

ANO
00/00

SIMPLES
T.E. / T.D.
LED VERMELHO ●
5 PINOS



YN-KG1690

VIDRO ELÉTRICO

APLICAÇÃO
GOLF

ANO
95/98

SIMPLES
D.D.
LED VERDE ●
6 PINOS



YN-KG1691

VIDRO ELÉTRICO

APLICAÇÃO
GOLF

ANO
95/98

DUPLO
D.E.
LED VERDE ●
12 PINOS



YN-KG0756

VIDRO ELÉTRICO

APLICAÇÃO
GOL G5
GOL G6
GOL G7
SAVEIRO G5
SAVEIRO G6
VOYAGE G5
VOYAGE G6

ANO
09/12
13/16
17/17
09/13
13/16
09/13
13/16

SIMPLES
D.E.
LED VERMELHO ●
4 PINOS



YN-KG1600

VIDRO ELÉTRICO

APLICAÇÃO
PASSAT
GOLF
BORA

ANO
98/05
99/12
00/11

QUÁDRUPLO
D.E.
C/ BLOQUEIO
C/ TRAVA PORTA
9 PINOS



YN-KG1681

VIDRO ELÉTRICO

APLICAÇÃO
CROSSFOX
FOX
GOL
POLO
SPACEFOX
UP

ANO
05/10
03/10
06/14
02/14
06/10
13/15

SIMPLES
T.D.
4 PINOS



YN-KG1692

VIDRO ELÉTRICO

APLICAÇÃO
GOL G6
VOYAGE G6

ANO
13/16
13/16

SIMPLES
CENTRAL
LED VERMELHO ●
6 PINOS



YN-KG1693

VIDRO ELÉTRICO

APLICAÇÃO
GOL G6
VOYAGE G6

ANO
13/16
13/16

SIMPLES
CENTRAL
LED VERMELHO ●
6 PINOS



YN-KG1694

VIDRO ELÉTRICO

APLICAÇÃO
GOL G6
VOYAGE G6

ANO
13/16
13/16

SIMPLES
CENTRAL
LED VERMELHO ●
6 PINOS



YN-KG1695

VIDRO ELÉTRICO

APLICAÇÃO ANO
 GOL G6 13/16
 VOYAGE G6 13/16
 SAVEIRO 14/16
 SIMPLES CENTRAL
 LED VERMELHO ●
 6 PINOS



YN-KG1697

VIDRO ELÉTRICO

APLICAÇÃO ANO
 GOL G7 16/16
 VOYAGE G7 16/16
 SIMPLES CENTRAL
 LED VERMELHO ●
 6 PINOS



YN-KG1698

VIDRO ELÉTRICO

APLICAÇÃO ANO
 GOL G7 17/22
 VOYAGE G7 17/22
 SIMPLES CENTRAL
 LED VERMELHO ●
 6 PINOS



YN-KG1734

VIDRO ELÉTRICO

APLICAÇÃO ANO
 GOL G5 09/12
 VOYAGE G5 09/15
 SIMPLES CENTRAL
 LED VERMELHO ●
 6 PINOS



YN-KG1717

VIDRO ELÉTRICO

APLICAÇÃO ANO TAMPA
 GOL G6 12/12
 VOYAGE G6 12/12
 LD



YN-KG1718

VIDRO ELÉTRICO

APLICAÇÃO ANO TAMPA
 GOL G6 12/12
 VOYAGE G6 12/12
 LE



YN-KG1699

VIDRO ELÉTRICO

APLICAÇÃO ANO
 GOL G2 96/99
 PARATI G2 96/99
 QUANTUM 92/94
 SANTANA 91/97
 SAVEIRO G2 96/99
 SIMPLES D.E.
 LED VERMELHO ●
 5 PINOS



YN-KG1700

VIDRO ELÉTRICO

APLICAÇÃO ANO
 GOL G3 00/05
 PARATI G3 00/05
 DUPLO C/BLOQUEIO
 CENTRAL
 LED VERMELHO ●
 8 PINOS



YN-KG1701

VIDRO ELÉTRICO

APLICAÇÃO ANO
 GOL G4 06/13
 PARATI G4 06/12
 DUPLO C/BLOQUEIO
 CENTRAL
 LED VERMELHO ●
 8 PINOS



YN-KG1719

VIDRO ELÉTRICO

APLICAÇÃO ANO
 GOL 88/88
 PARATI 88/88
 VOYAGE 88/88
 SAVEIRO 88/88
 LD
 PORTA FRONTAL



YN-KG1720

VIDRO ELÉTRICO

APLICAÇÃO ANO
 GOL 88/88
 PARATI 88/88
 VOYAGE 88/88
 SAVEIRO 88/88
 L.E.
 PORTA FRONTAL



YN-KG1721

VIDRO ELÉTRICO

APLICAÇÃO ANO
 GOL G5 08/12
 VOYAGE 08/12
 SAVEIRO 08/12
 L.E.
 PORTA TRASEIRA



YN-KG1702

VIDRO ELÉTRICO

APLICAÇÃO ANO
 GOL G5 09/12
 VOYAGE G5 09/12
 SIMPLES CENTRAL
 LED VERMELHO ●
 4 PINOS



YN-KG1703

VIDRO ELÉTRICO

APLICAÇÃO ANO
 GOL G5 09/12
 VOYAGE G5 09/12
 SIMPLES CENTRAL
 LED VERMELHO ●
 4 PINOS



YN-KG1704

VIDRO ELÉTRICO

APLICAÇÃO ANO
 GOL G5 09/11
 VOYAGE G5 09/11
 SIMPLES CENTRAL
 LED VERMELHO ●
 5 PINOS



YN-KG1722

VIDRO ELÉTRICO

APLICAÇÃO ANO
 GOL G5 08/12
 VOYAGE 08/12
 SAVEIRO 08/12
 LD
 PORTA TRASEIRA



YN-KG1723

VIDRO ELÉTRICO

APLICAÇÃO ANO
 GOL G5/G6 13/16
 VOYAGE G5/G6 13/16
 SAVEIRO G5/G6 13/16
 L.E.
 PORTA FRONTAL



YN-KG1724

VIDRO ELÉTRICO

APLICAÇÃO ANO
 GOL G5/G6 13/16
 VOYAGE G5/G6 13/16
 SAVEIRO G5/G6 13/16
 LD
 PORTA FRONTAL



YN-KG1706

VIDRO ELÉTRICO

APLICAÇÃO ANO
 CROSSFOX 03/09
 FOX 03/09
 SPACEFOX 03/09
 SIMPLES CENTRAL
 LED VERMELHO ●
 6 PINOS



YN-KG1729

VIDRO ELÉTRICO

APLICAÇÃO ANO
 GOL G3 00/05
 GOL G4 06/14
 PARATI G3 00/05
 PARATI G4 06/14
 SAVEIRO G3 00/05
 SAVEIRO G4 06/10
 SIMPLES CENTRAL
 LED VERMELHO ●
 5 PINOS



YN-KG1730

VIDRO ELÉTRICO

APLICAÇÃO ANO
 CROSSFOX 10/14
 FOX 10/14
 SPACEFOX 10/14
 SIMPLES CENTRAL
 LED VERMELHO ●
 6 PINOS



YN-KG1725

VIDRO ELÉTRICO

APLICAÇÃO ANO
 GOL G6/G7 10/17
 VOYAGE 10/17
 SAVEIRO 10/17
 L.E.
 TRASEIRA



YN-KG1726

VIDRO ELÉTRICO

APLICAÇÃO ANO
 GOL G6/G7 10/17
 VOYAGE 10/17
 SAVEIRO 10/17
 LD
 TRASEIRA



YN-KG1727

VIDRO ELÉTRICO

APLICAÇÃO ANO
 GOL G6 13/16
 VOYAGE G6 13/16
 SAVEIRO G6 13/16
 L.E.
 DIANTEIRA
 PORTA FRONTAL



YN-KG1728
VIDRO ELÉTRICO

APLICAÇÃO
GOL G6
VOYAGE G6
SAVEIRO G6

ANO
13/16
13/16
13/16

L.D.
DIANTEIRA
PORTA FRONTAL



YN-KG1183
VIDRO ELÉTRICO

APLICAÇÃO
DUSTER
SANDERO
LOGAN
MEGANE II G.TOUR

ANO
11/15
07/14
07/13
07/12

DUPLO
D.E.
LED AMBAR ●
10 PINOS



YN-KG1715
VIDRO ELÉTRICO

APLICAÇÃO
FIT
CITY

ANO
09>
11>

QUÁDRUPLO
D.E.
22 PINOS



YN-KG1716
VIDRO ELÉTRICO

APLICAÇÃO
CIVIC

ANO
12>

SIMPLES
T.E./T.D.
5 PINOS



YN-KG1712
VIDRO ELÉTRICO

APLICAÇÃO
CLIO
MEGANE

ANO
99>
99>

SIMPLES
D.E./D.D.
LED AMBAR ●
5 PINOS



YN-KG1713
VIDRO ELÉTRICO

APLICAÇÃO
CLIO
MEGANE

ANO
99>
99>

SIMPLES
D.E./D.D.
LED AMBAR ●
6 PINOS



YN-KG1714
VIDRO ELÉTRICO

APLICAÇÃO
CLIO
SANDERO
DUSTER
MASTER
CAPTUR

ANO
17>
17>
17>
17>
17>

SIMPLES
CENTRAL
8 PINOS



YN-KG1708
VIDRO ELÉTRICO

APLICAÇÃO
PEUGEOT 307
PEUGEOT 406

ANO
04>
04>

SIMPLES
D.D./T.E./T.E.
LED VERMELHO ●
4 PINOS



YN-KG1709
VIDRO ELÉTRICO

APLICAÇÃO
PEUGEOT 206

ANO
99>

DUPLO
D.E./D.D.
LED VERMELHO ●
6 PINOS



YN-KG1710
VIDRO ELÉTRICO

APLICAÇÃO
PEUGEOT 206

ANO
98/10

DUPLO
D.E./D.D.
LED VERMELHO ●
6 PINOS



YN-KG1739
VIDRO ELÉTRICO

APLICAÇÃO
MASTER

ANO
13>

SIMPLES
D.E./D.D.
LED AMBAR ●
5 PINOS



YN-KG1602
VIDRO ELÉTRICO

APLICAÇÃO
SPRINTER
311 / 415 / 515

ANO
13>

DUPLO C/RETROVISOR
D.E.
7 PINOS

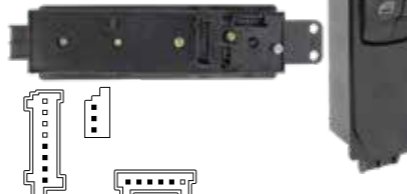

YN-KG1711
VIDRO ELÉTRICO

APLICAÇÃO
PEUGEOT 206

ANO
01/08

DUPLO
CENTRAL
5 PINOS



YN-KG1738
VIDRO ELÉTRICO

APLICAÇÃO
PEUGOET 307
PEUGOET 406

ANO
04>
04>

QUÁDRUPLO
D.E.
LED VERMELHO ●
9 PINOS



YN-KG1599
VIDRO ELÉTRICO

APLICAÇÃO
FIT
CITY

ANO
09>
11>

QUÁDRUPLO
D.E.
22 PINOS



YN-KG1601
VIDRO ELÉTRICO

APLICAÇÃO
CIVIC

ANO
06/11

QUÁDRUPLO
D.E.
22 PINOS



YN-EB0629

APOIO DE BRAÇO UNIVERSAL

- Apoio de Braço macio revestido em couro ecológico.
- Console e Suporte em plástico ABS super resistente.
- Adaptável em qualquer veículo.
- **Necessário que uma 1 entrada USB esteja ligada ao acendedor de cigarro, para que as outras 3 funcionem.**
- **Fácil Instalação sem necessidade de parafusos.**

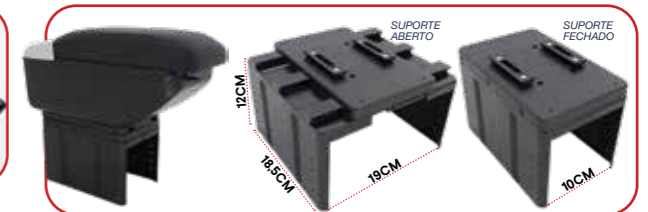
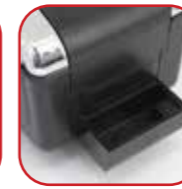

APOIOS DE BRAÇO UNIVERSAIS

YN-EB0630

APOIO DE BRAÇO UNIVERSAL

- Apoio de Braço macio revestido em couro ecológico.
- Console em plástico ABS super resistente.
- Adaptável em qualquer veículo.
- **Fácil Instalação sem necessidade de parafusos.**



YN-EB0631

APOIO DE BRAÇO UNIVERSAL

- Apoio de Braço macio revestido em couro ecológico.
- Console em plástico ABS super resistente.
- Adaptável em qualquer veículo.
- **Fácil Instalação sem necessidade de parafusos.**



YN-EB0632

APOIO DE BRAÇO UNIVERSAL

- Apoio de Braço macio revestido em couro ecológico.
- Console em plástico ABS super resistente.
- Adaptável em qualquer veículo.
- **Fácil Instalação sem necessidade de parafusos.**



AUDIO

ÁUDIO E VÍDEO

VIDEO



YN-MD1872



TELA COM 9" POL



VISÃO GERAL

- 32 GB** Memória Interna
- 2 GB** Memória RAM
- Android 12**
- 2 DIN** Tamanho 2 DIN
- Tela 2.5D IPS
- 8 CORE** CPU
- HD** Resolução 1280 x 720
- Comando de Volante
- Entrada Câmera de Ré

CONECTIVIDADE

- Espeilhamento Wireless
- 5G** 2.4 / 5G WI-FI
- Bluetooth 5.0
- GPS Offline Integrado
- Navegador Web
- 2 Portas USB
- Dock Micro SIM Card

ÁUDIO & VÍDEO

- 50w RMS** Máxima Potência
- Equalizador Multi
- Rádio FM
- 3 Saídas RCA Áudio
- 1 Saída RCA Vídeo
- 3 Entradas Aux.



Peso Embalagem: 1.175 gramas
 Peso do Aparelho: 749 gramas
 Tamanho da Caixa: 30 x 19,3 x 8 cm

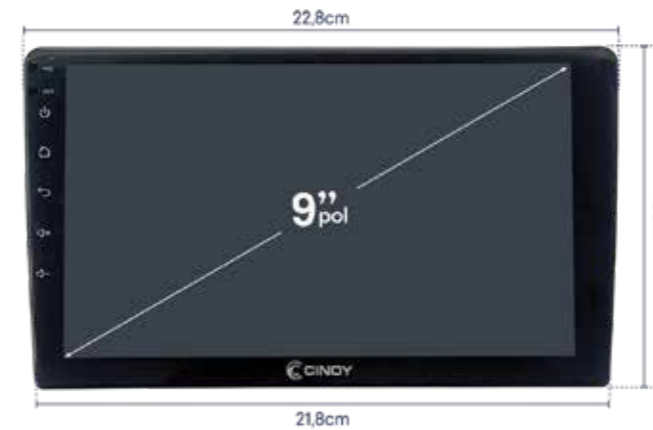

CARACTERÍSTICAS TÉCNICAS

Gerais
 Voltagem DC 14,4
 Potência: 50w
 Impedância: 4 Ohms
 Extensões: Três telas divididas, OBD, DVR, ADAS, VART, VIOCE
 Saída de áudio: 4 x 45w
 Controle de Tons Graves (100Hz) / Agudos (10HZ):
 Temperatura de operação: -40°C a 85°C
 Idiomas: Árabe, Espanhol, Francês, Hebraico, Inglês, Português, Russo, Tailandês, Turco, Vietnamita
 Função Sleep: Possui
 Senha para configurações avançadas:

Rádio
 Módulo Rádio: QN8035
 Frequência FM: 76-108Hz (América do Sul)
 Frequência AM: 520-1710Hz (América do Sul)

Vídeo
 Sistema de vídeo: NTSC
 Formatos de vídeo: MP4, 3GP, AVI, DVIX, FLU, MKV
 Formatos de imagem: JPG, PNG, JPEG, BMP

Áudio
 Saída de Áudio: 4.1 CH
 Processador de som: AK7604
 Amplificador: YD7388
 Formatos de áudio: MP3, ACC, FLAC, WAV, WMA, M4A, MP2, ARM/OGG
 Equalizador: JAZZ, POP, CLASSICO, ROCK, NOVO, URBANO, TECHNO

Bluetooth
 Bluetooth Áudio Streaming (Músicas)
 Bluetooth Hands-Free (Chamadas Telefônicas)
 Tipo de comunicação: 5.0
 Nome: Senha:

CARACTERÍSTICAS DO SISTEMA

Sistema: Android 12
 Versão do Sistema: TS18.2.1-100-10-A59899D
 CPU: OCTA-UI58581A/A55/16GHZ
 GPU: PowerVR Fentale GE8322 até 550 MHZ
 RAM/ROW: 2+32GB
 Espelhamento: Android e IOS
 Espelhamento via cabo e via bluetooth
 APP: Android Auto e Apple Carplay
 FOTA Atualização: Suporta



YN-MD1869



VISÃO GERAL

- 32 GB** Memória Interna
- 2 GB** Memória RAM
- Android 12**
- 2 DIN** Tamanho 2 DIN
- Tela 2.5D IPS
- 8 CORE** CPU
- HD** Resolução 1280 x 720
- Comando de Volante
- Entrada Câmera de Ré

CONECTIVIDADE

- Espelhamento Wireless
- 5G** 2.4 / 5G WI-FI
- Bluetooth 5.0
- GPS Offline Integrado
- Navegador Web
- 1 Portas USB
- Dock Micro SIM Card

ÁUDIO & VÍDEO

- 50w RMS** Mámixa Potência
- Equalizador Multi
- Rádio FM
- 3 Saídas RCA Áudio
- 1 Saída RCA Vídeo
- 3 Entradas Aux.



Peso Embalagem: 1.175 gramas
 Peso do Aparelho: 749 gramas
 Tamanho da Caixa: 30 x 19,3 x 8 cm

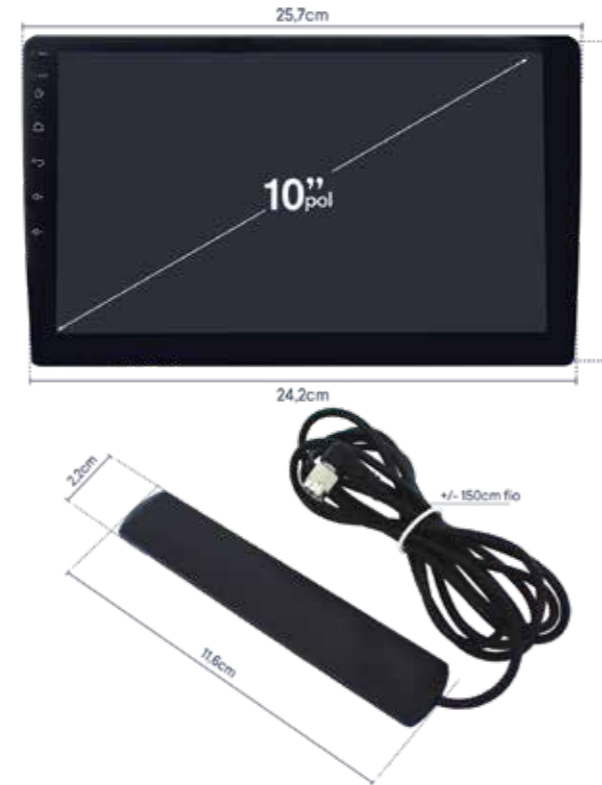

CARACTERÍSTICAS TÉCNICAS

Gerais
 Voltagem DC 14,4
 Potência: 50w
 Impedância: 4 Ohms
 Extensões: Três telas divididas, OBD, DVR, ADAS, VART, VIOCE
 Saída de áudio: 4 x 45w
 Controle de Tons Graves (100Hz) / Agudos (10HZ):
 Temperatura de operação: -40°C a 85°C
 Idiomas: Árabe, Espanhol, Francês, Hebraico, Inglês, Português, Russo, Tailandês, Turco, Vietnamita
 Função Sleep: Possui
 Senha para configurações avançadas:

Rádio
 Módulo Rádio: QN8035
 Frequência FM: 76-108Hz (América do Sul)
 Frequência AM: 520-1710Hz (América do Sul)

Vídeo
 Sistema de vídeo: NTSC
 Formatos de vídeo: MP4, 3GP, AVI, DVIX, FLU, MKV
 Formatos de imagem: JPG, PNG, JPEG, BMP

Áudio
 Saída de Áudio: 4.1 CH
 Processador de som: AK7604
 Amplificador: YD7388
 Formatos de áudio: MP3, ACC, FLAC, WAV, WMA, M4A, MP2, ARM/OGG
 Equalizador: JAZZ, POP, CLASSICO, ROCK, NOVO, URBANO, TECHNO

Bluetooth
 Bluetooth Áudio Streaming (Músicas)
 Bluetooth Hands-Free (Chamadas Telefônicas)
 Tipo de comunicação: 5.0
 Nome: Senha:

CARACTERÍSTICAS DO SISTEMA

Sistema: Android 12
 Versão do Sistema: TS18.2.1-100-10-A59899D
 CPU: OCTA-U158581A/A55/16GHZ
 GPU: PowerVR Fentale GE8322 até 550 MHZ
 RAM/ROW: 2+32GB
 Espelhamento: Android e IOS
 Espelhamento via cabo e via bluetooth
 APP: Android Auto e Apple Carplay
 FOTA Atualização: Suporta



YN-MD1387



TELA COM 7" POL



VISÃO GERAL

- Android 12
- Tamanho 2 DIN
- 7" Touch Screen HD, resistive touch
- Resolução 1024x600p
- Comando de Volante
- Entrada Câmera de Ré

CONECTIVIDADE

- Espelhamento Wireless
- Bluetooth 4.2
- GPS Offline Integrado
- Navegador Web
- Porta USB POWER
- Porta MMC CARD / SD Card
- Controle Remoto

ÁUDIO & VÍDEO

- Mámixa Potência
- Equalizador Multi
- Rádio Estéreo FM / AM
- 2 Saídas RCA Áudio
1 Saída RCA Vídeo
- 2 Entradas Câmera Ré (Frontal e Traseira)
- 1 Entrada Subwoofer
- 1 Entrada Aux.



Peso Embalagem: 1.175 gramas
Peso do Aparelho: 749 gramas
Tamanho da Caixa: 30 x 19,3 x 8 cm

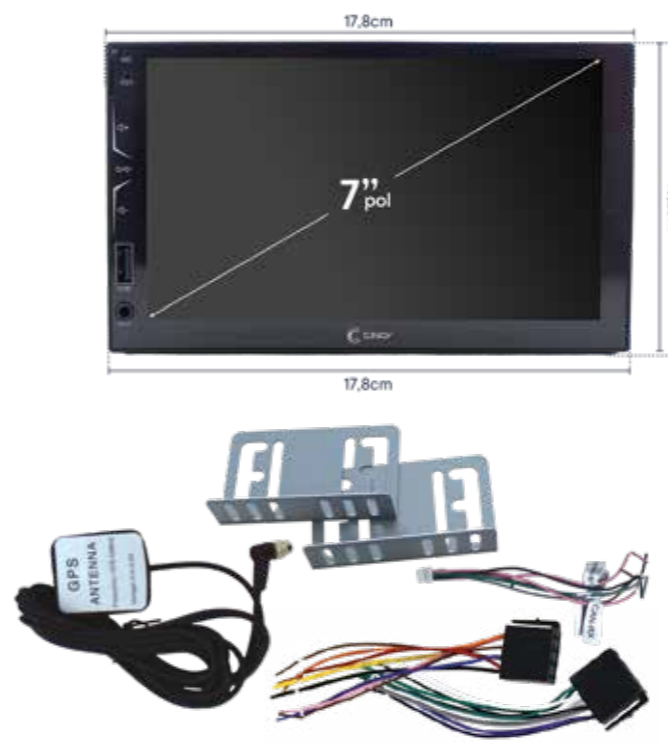

CARACTERÍSTICAS TÉCNICAS

Gerais
 Voltagem DC 12V
 Potência: 4x45w
 Impedância: 8 Ohms
 Saída de áudio: 4x45w
 Controle de Tons Graves (100Hz) / Agudos (10HZ):
 Temperatura de operação: -20°C - +60°C
 Idiomas: Inglês, Russo, Hebraico, Árabe, Português, Turco, Francês, Espanhol, Tailandes, Vietnamita
 Função Sleep: Possui
 Senha para configurações avançadas: 6556

Rádio
 Frequência FM: 76-108Hz (América do Sul)
 Frequência AM: 520-1710Hz (América do Sul)
 Relação sinal/ruído: 60dB
 Separação estéreo (1KHz): 30dB

Vídeo
 Sistema de vídeo: NTSC
 Nível saída de vídeo: 1.0Vp-p 750hms
 Formatos de vídeo: MP4/MP5/RM/RMVB/AVI
 Formatos de imagem: BMP/GIF/JPG/PNG

Áudio
 Nível max de saída: 2Vms (+/-3dB)
 Reposta de frequência: 20Hz to 20KHz
 Relação sinal ruído: 85dB
 Separação de canais: 80Db
 Formatos de áudio: MP3,WMA
 Equalizador: JAZZ, POP, CLASSICO, ROCK, NOVO, URBANO,TECHNO

Bluetooth
 Bluetooth Áudio Streaming (Músicas)
 Bluetooth Hands-Free (Chamadas Telefônicas)
 Distância: 5 metros
 Tipo de comunicação: 4.2
 Nome: CAR-BT Senha: 1234



CARACTERÍSTICAS DO SISTEMA

Sistema: Android 8.1 (OREO)
 Versão do Sistema: OS_v2.0.5WF_GWI_DNYB
 CPU: CM_21.06.30_12.30
 Kernel: Linux version 3.18.79
 RAM/ROM: 1+16Gb
 Espelhamento: Android e IOS
 Espelhamento via cabo e via wireless
 APP: CarbitLink (versão: 4.0.0.1)
 FOTA: Suporta
 OBS: Para futuras atualizações de software entrar em contato com o fabricante.

INFORMAÇÕES LOGÍSTICAS

Unidades por caixa: 06
 Peso Bruto por unidade: 1,075Kg
 Peso Líquido por unidade: 0,903Kg
 Peso Bruto por Caixa: 6,900vKg



YN-RAD1522



VISÃO GERAL

- Android 12
- Tamanho 2 DIN
- 7" Touch Screen HD, resistive touch
- Resolução 800x480P
- Comando de Volante
- Entrada Câmera de Ré

CONECTIVIDADE

- Espelhamento Wireless
- Bluetooth 4.2
- GPS Offline Integrado
- Navegador Web
- Porta USB POWER
- Porta MMC CARD / SD Card
- Controle Remoto

ÁUDIO & VÍDEO

- Mâmixa Potência
- Equalizador Multi
- Rádio Estéreo FM / AM
- 2 Saídas RCA Áudio
1 Saída RCA Vídeo
- 2 Entradas Câmera Ré (Frontal e Traseira)
- 1 Entrada Subwoofer
- 1 Entrada Aux.



Peso Embalagem: 1.175 gramas
Peso do Aparelho: 749 gramas
Tamanho da Caixa: 30 x 19,3 x 8 cm



CARACTERÍSTICAS TÉCNICAS

Gerais
 Voltagem DC 12V
 Potência: 4x45w
 Impedância: 8 Ohms
 Saída de áudio: 4x45w
 Controle de Tons Graves (100Hz) / Agudos (10HZ):
 Temperatura de operação: -20°C - +60°C
 Idiomas: Inglês, Russo, Hebraico, Árabe, Português, Turco, Francês, Espanhol, Tailandês, Viatnamita
 Função Sleep: Possui
 Senha para configurações avançadas: 6556

Rádio
 Frequência FM: 76-108Hz (América do Sul)
 Frequência AM: 520-1710Hz (América do Sul)
 Separação estéreo (1KHz): 25dB

Vídeo
 Sistema de vídeo: NTSC/PAL/AUTO
 Nível saída de vídeo: 750hms
 Formatos de vídeo: MP4/MP5/RM/RMVB/AVI
 Formatos de imagem: BMP/GIF/JPG/PNG

Áudio
 Formatos de áudio: MP3,WMA
 Equalizador: JAZZ, POP, CLASSICO, ROCK, NOVO, URBANO,TECHNO

Bluetooth
 Bluetooth Áudio Streaming (Músicas)
 Bluetooth Hands-Free (Chamadas Telefônicas)
 Distância: 5 metros
 Tipo de comunicação: 4.2
 Nome: CAR-BT Senha: 0000

CARACTERÍSTICAS DO SISTEMA

Sistema:
 Versão do Sistema: V2.11.500.31 191112_185731
 MCU: 01/03/2001 14:29:00
 Espelhamento: Android e IOS
 Espelhamento via cabo e via wireless
 APP: AutoLink
 OBS: Para futuras atualizações de software entrar em contato com o fabricante.

INFORMAÇÕES LOGÍSTICAS

Unidades por caixa: 04
 Peso Bruto por unidade: 1,950Kg
 Peso Líquido por unidade: 1,752Kg
 Peso Bruto por Caixa: 8,450Kg



YN-RAD1523



VISÃO GERAL

- Android 12
- Tamanho 2 DIN
- 7" Touch Screen Full HD, resistive touch
- Resolução 1080P
- Comando de Volante
- Entrada Câmera de Ré

CONECTIVIDADE

- Espelhamento Wireless
- Bluetooth 4.2
- GPS Offline Integrado
- Navegador Web
- Porta USB POWER
- Porta MMC CARD / SD Card
- Controle Remoto

ÁUDIO & VÍDEO

- Mámixa Potência
- Equalizador Multi
- Rádio Estéreo FM / AM
- 2 Saídas RCA Áudio
1 Saída RCA Vídeo
- 2 Entradas RCA Áudio
1 Entrada RCA Vídeo
- 2 Entradas Câmera Ré (Frontal e Traseira)
- 1 Entrada Subwoofer
- 1 Entrada Aux.



Peso Embalagem: 1.175 gramas
Peso do Aparelho: 749 gramas
Tamanho da Caixa: 30 x 19,3 x 8 cm



CARACTERÍSTICAS TÉCNICAS

Gerais
 Voltagem DC 12V
 Potência: 4x45w
 Impedância: 8 Ohms
 Saída de áudio: 4 x 45w
 Controle de Tons Graves (100Hz) / Agudos (10HZ):
 Temperatura de operação: -20°C - +60°C
 Idiomas: Inglês, Russo, Hebraico, Árabe, Português, Turco, Francês, Espanhol, Tailandes, Vietnamita
 Função Sleep: Possui
 Senha para configurações avançadas: 6556

Rádio
 Frequência FM: 76-108Hz (América do Sul)
 Frequência AM: 520-1710Hz (América do Sul)
 Separação estéreo (1KHz): 25dB

Vídeo
 Sistema de vídeo: NTSC/PAL/AUTO
 Nível saída de vídeo: 750hms
 Formatos de vídeo: MP4/MP5/RM/RMVB/AVI
 Formatos de imagem: BMP/GIF/JPG/PNG

Módulo de TV
 Integrado: Armazena até 100 canais - ISDB-T

Áudio
 Formatos de áudio: MP3,WMA
 Equalizador: JAZZ, POP, CLASSICO, ROCK, NOVO, URBANO, TECHNO

Bluetooth
 Bluetooth Áudio Streaming (Músicas)
 Bluetooth Hands-Free (Chamadas Telefônicas)
 Distância: 5 metros
 Tipo de comunicação: 4.2
 Nome: CAR-BT Senha: 0000

CARACTERÍSTICAS DO SISTEMA

Sistema:
 Versão do Sistema: V2.11.500.31 200905_123300
 MCU: 01/03/2001 14:29:00
 Espelhamento: Android e IOS
 Espelhamento via cabo e via wireless
 APP: AutoLink
 OBS: Para futuras atualizações de software entrar em contato com o fabricante.

INFORMAÇÕES LOGÍSTICAS

Unidades por caixa: 06
 Peso Bruto por unidade: 1,067Kg
 Peso Líquido por unidade: 0,856Kg
 Peso Bruto por Caixa: 6,85Kg



YN-RAD71175



TELA COM 7" POL



VISÃO GERAL

- Android 12
- Tamanho 2 DIN
- 7" Touch Screen Full HD, resistive touch
- Resolução 1080P
- Comando de Volante
- Entrada Câmera de Ré

CONECTIVIDADE

- Espelhamento Wireless
- Bluetooth 4.2
- GPS Offline Integrado
- Navegador Web
- Porta USB
- Porta MMC CARD / SD Card
- Controle Remoto

ÁUDIO & VÍDEO

- Mámixa Potência
- Equalizador Multi
- Rádio Estéreo AM / FM
- 2 Saídas RCA Áudio
2 Saídas RCA Vídeo
- 1 Entrada Vídeo
- 1 Entrada Aux.
- 1 Entrada Subwoofer



Peso Embalagem: 1.175 grammas
Peso do Aparelho: 749 grammas
Tamanho da Caixa: 30 x 19,3 x 8 cm

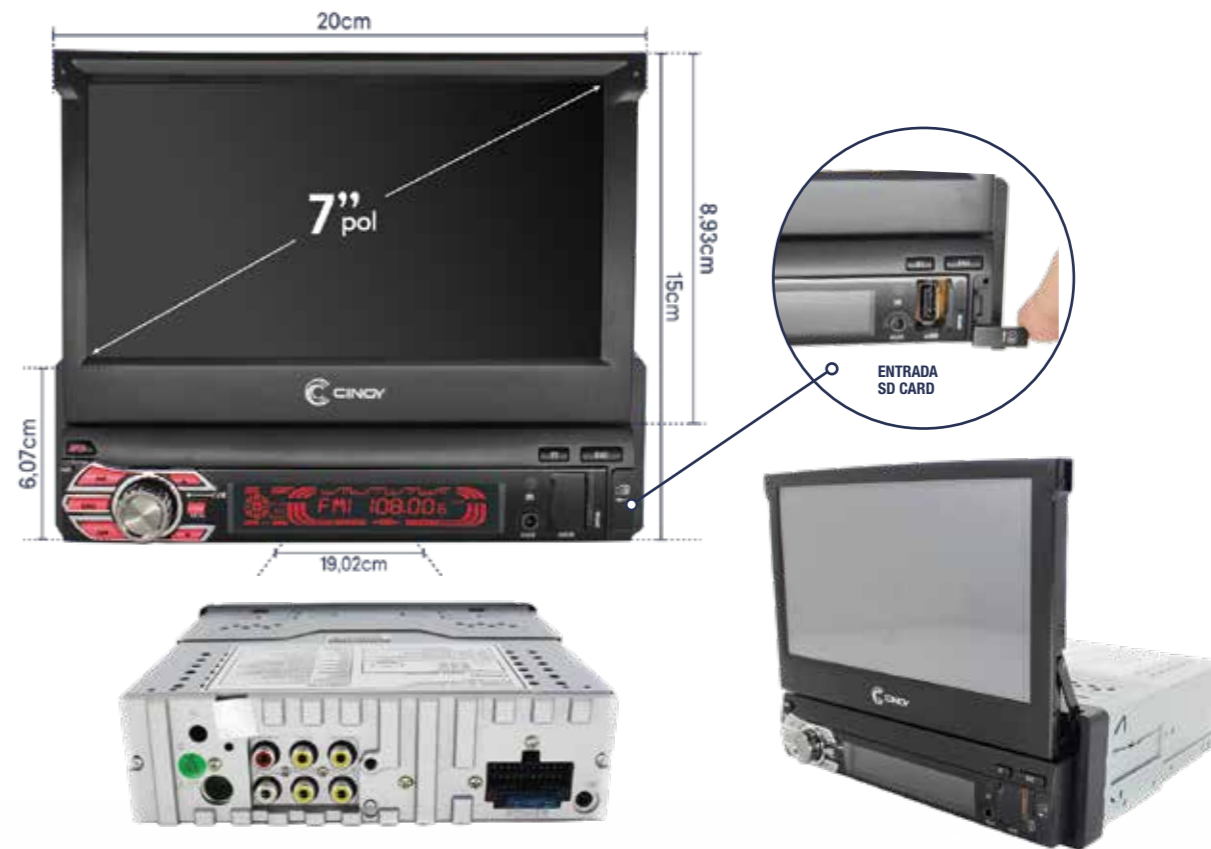

CARACTERÍSTICAS TÉCNICAS

Gerais
 Voltagem DC 12V
 Potência: 4x45w
 Impedância: 8 Ohms
 Extensões:
 Saída de áudio: 4 x 45w
 Controle de Tons Graves (100Hz) / Agudos (10HZ):
 Temperatura de operação: -20°C - +60°C
 Idiomas: Inglês, Russo, Hebraico, Árabe, Português,
 Turco, Francês, Espanhol, Tailandes, Vietnamita
 Função Sleep: Possui
 Senha para configurações avançadas: XXXX

Rádio
 Módulo Rádio:
 Frequência FM: 76-108Hz (América do Sul)
 Frequência AM: 520-1710Hz (América do Sul)
 Separação estéreo (1KHz): 25dB

Vídeo
 Sistema de vídeo: NTSC/PAL/AUTO
 Formatos de vídeo: MP4/MP5/RM/RMVB/AVI
 Formatos de imagem: BMP/GIF/JPG/PNG

Áudio
 Formatos de áudio: MP3,WMA
 Equalizador: JAZZ, POP, CLASSICO, ROCK, NOVO, URBANO, TECHNO

Bluetooth
 Bluetooth Áudio Streaming (Músicas)
 Bluetooth Hands-Free (Chamadas Telefônicas)
 Distância: 5 metros
 Tipo de comunicação: 4.2
 Nome: CAR-BT Senha: NÃO TEM

CARACTERÍSTICAS DO SISTEMA

Sistema:
 Versão do Sistema: V2.11.500.31 200905_123300
CPU:
GPU:
RAM/ROW:
 Espelhamento: Android e IOS
 Espelhamento via cabo e via wireless
APP: AutoLink
FOTA Atualização: Suporta

INFORMAÇÕES LOGÍSTICAS

Unidades por caixa:
 Peso Bruto por unidade:
 Peso Líquido por unidade:
 Peso Bruto por Caixa:



YN-RAD1870



VISÃO GERAL

- Android 12
- Tamanho 2 DIN
- 7" Touch Screen Full HD, resistive touch
- Resolução 1080P
- Comando de Volante
- Entrada Câmera de Ré

CONECTIVIDADE

- Espelhamento Wireless
- Bluetooth 4.2
- GPS Offline Integrado
- Navegador Web
- Porta USB
- Porta MMC CARD / SD Card
- Controle Remoto

ÁUDIO & VÍDEO

- Mámixa Potência
- Equalizador Multi
- Rádio Estéreo AM / FM
- 2 Saídas RCA Áudio
2 Saídas RCA Vídeo
- 1 Entrada Vídeo
- 1 Entrada Aux.
- 1 Entrada Subwoofer



Peso Embalagem: 1.175 gramas
Peso do Aparelho: 749 gramas
Tamanho da Caixa: 30 x 19,3 x 8 cm



CARACTERÍSTICAS TÉCNICAS

Gerais
 Voltagem DC 14V
 Potência: 4x45w
 Impedância: 75 Ohms
 Extensões:
 Saída de áudio: 4x45w
 Controle de Tons Graves (100Hz) / Agudos (10HZ):
 Temperatura de operação: -20°C - +60°C
 Idiomas: Inglês, Russo, Hebraico, Árabe, Português,
 Turco, Francês, Espanhol, Tailandês, Vietnamita
 Função Sleep: Possui
 Senha para configurações avançadas:

Rádio
 Módulo Rádio:
 Frequência FM: 76-108Hz (América do Sul)
 Frequência AM: 520-1710Hz (América do Sul)
 Separação estéreo (1KHz): 25dB

Vídeo
 Sistema de vídeo: NTSC/PAL/AUTO
 Formatos de vídeo: MP4/MP5/RM/RMVB/AVI
 Formatos de imagem: BMP/GIF/JPG/PNG

Áudio
 Formatos de áudio: MP3,WMA
 Equalizador: JAZZ, POP, CLASSICO, ROCK, NOVO, URBANO, TECHNO

Bluetooth
 Bluetooth Áudio Streaming (Músicas)
 Bluetooth Hands-Free (Chamadas Telefônicas)
 Distância: 5 metros
 Tipo de comunicação: 4.2
 Nome: CAR-BT Senha: NÃO TEM

CARACTERÍSTICAS DO SISTEMA

Sistema:
 BOOT: OCT 9 2021 10:59:16-DA005
 MCU: Mar 25 12:5259D
 Espelhamento: Android e IOS
 Espelhamento via cabo e via wireless
 APP: Android Auto e CarPlay

INFORMAÇÕES LOGÍSTICAS

Unidades por caixa:
 Peso Bruto por unidade:
 Peso Líquido por unidade:
 Peso Bruto por Caixa:



YN-RAD101342

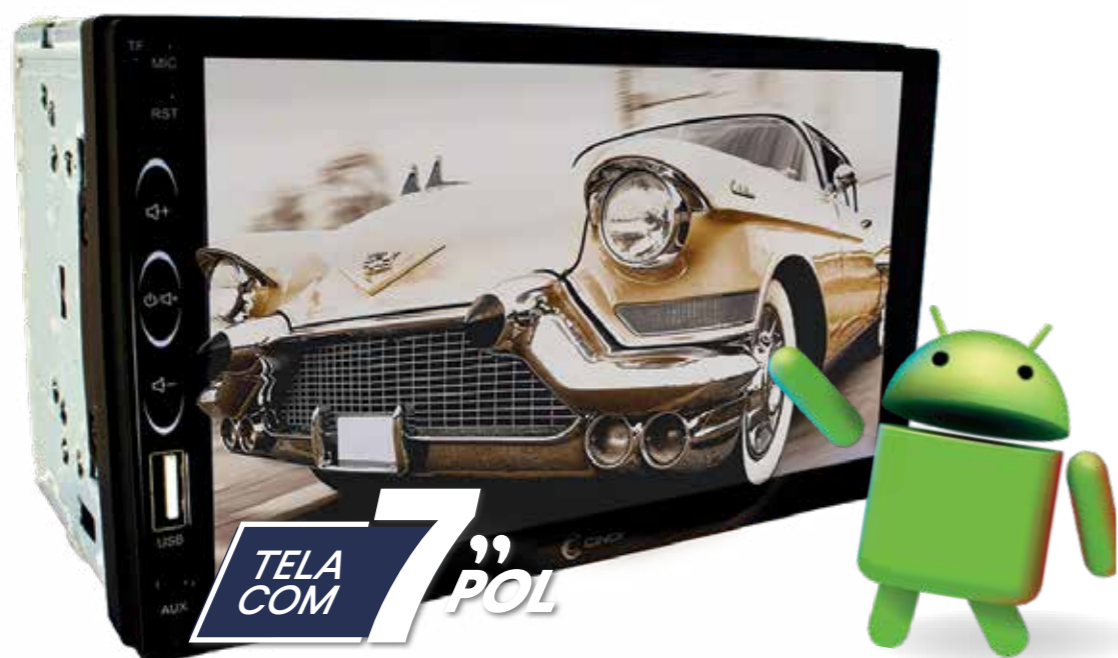

VISÃO GERAL

- Android 12
- Tamanho 2 DIN
- 7" Touch Screen Full HD, resistive touch
- Resolução 720P
- Comando de Volante
- Entrada Câmera de Ré

CONECTIVIDADE

- Espelhamento Wireless
- Bluetooth 4.2
- GPS Offline Integrado
- Navegador Web
- Porta USB
- Porta MMC CARD / SD Card
- Controle Remoto

ÁUDIO & VÍDEO

- Máxima Potência
- Equalizador Multi
- Rádio Estéreo AM / FM
- 2 Saídas RCA Áudio
2 Saídas RCA Vídeo
- 1 Entrada Vídeo
- 1 Entrada Aux.
- 1 Entrada Subwoofer



Peso Embalagem: 1.175 gramas
Peso do Aparelho: 749 gramas
Tamanho da Caixa: 30 x 19,3 x 8 cm

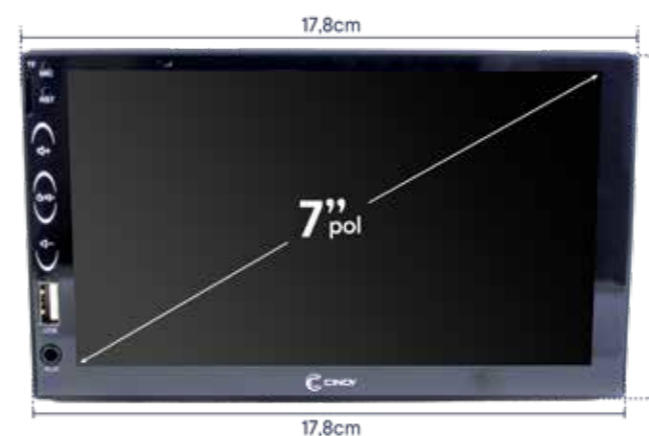

CARACTERÍSTICAS TÉCNICAS

Gerais
Voltagem DC 12V
Potência: 4x45w
Impedância: 8 Ohms
Extensões:
Saída de áudio: 4 x 45w
Controle de Tons Graves (100Hz) / Agudos (10HZ):
Temperatura de operação: -20°C - +60°C
Idiomas: Inglês, Russo, Hebraico, Árabe, Português, Turco, Francês, Espanhol, Tailandes, Vietnamita
Função Sleep: Possui
Senha para configurações avançadas: 1234

Rádio
Estéreo
Frequência FM: 76-108Hz (América do Sul)
Frequência AM: 520-1710Hz (América do Sul)
Separação estéreo (1KHz): 25dB

Vídeo
Sistema de vídeo: NTSC/PAL/AUTO
Formatos de vídeo: MP4/MP5/RM/RMVB/AVI
Formatos de imagem: BMP/GIF/JPG/PNG

Áudio
Formatos de áudio: MP3, WMA
Equalizador: JAZZ, POP, CLASSICO, ROCK, NOVO, URBANO, TECHNO

Bluetooth
Bluetooth Áudio Streaming (Músicas)
Bluetooth Hands-Free (Chamadas Telefônicas)
Distância: 5 metros
Tipo de comunicação: 4.2
Nome: CAR-BT Senha: 1234

CARACTERÍSTICAS DO SISTEMA

Versão do Sistema: V7.5BT-FK-TP
Info: SK-848V6.9C-C200S
MCU: 09/01/2022 15:42
Caminho MCU: hsn_6925,bfu
Caminho: C200-C200S-ePDKv100.img
Espelhamento: Android e iOS
Espelhamento via cabo e via wireless
APP: AutoLink
OBS: Para futuras atualizações de software entrar em contato com o fabricante.

INFORMAÇÕES LOGÍSTICAS

Unidades por caixa: 06
Peso Bruto por unidade: 0,890kg
Peso Líquido por unidade: 0,726kg
Peso Bruto por Caixa: 5,800kg



YN-RAD71283



VISÃO GERAL

- Android 12
- Tamanho 2 DIN
- 7" Touch Screen Full HD, resistive touch
- Resolução 1080P
- Comando de Volante
- Entrada Câmera de Ré

CONECTIVIDADE

- Espelhamento Wireless
- Bluetooth 4.2
- GPS Offline Integrado
- Navegador Web
- Porta USB
- Porta MMC CARD / SD Card
- Controle Remoto

ÁUDIO & VÍDEO

- Máxima Potência
- Equalizador Multi
- Rádio Estéreo AM / FM
- 2 Saídas RCA Áudio
2 Saídas RCA Vídeo
- 1 Entrada Vídeo
- 1 Entrada Aux.



Peso Embalagem: 1.175 gramas
Peso do Aparelho: 749 gramas
Tamanho da Caixa: 30 x 19,3 x 8 cm



CARACTERÍSTICAS TÉCNICAS

Gerais
Voltagem DC 12V
Potência: 4x45w
Impedância: 8 Ohms
Extensões:
Saída de áudio: 4x45w
Controle de Tons Graves (100Hz) / Agudos (10HZ):
Temperatura de operação: -20°C - +60°C
Idiomas: Inglês, Russo, Hebraico, Árabe, Português, Turco, Francês, Espanhol, Tailandês, Vietnamita
Função Sleep: Possui
Senha para configurações avançadas: 6556

Rádio
Módulo Rádio:
Frequência FM: 76-108Hz (América do Sul)
Frequência AM: 520-1710Hz (América do Sul)
Separação estéreo (1KHz): 25dB

Vídeo
Sistema de vídeo: NTSC/PAL/AUTO
Formatos de vídeo: MP4/MP5/RM/RMVB/AVI
Formatos de imagem: BMP/GIF/JPG/PNG

Áudio
Formatos de áudio: MP3, WMA
Equalizador: JAZZ, POP, CLASSICO, ROCK, NOVO, URBANO, TECHNO

Bluetooth
Bluetooth Áudio Streaming (Músicas)
Bluetooth Hands-Free (Chamadas Telefônicas)
Distância: 5 metros
Tipo de comunicação: 4.2
Nome: CAR-BT Senha: 0000

CARACTERÍSTICAS DO SISTEMA

Versão do Sistema: V2.11.500.31 191112_185731
MCU: 01/03/2001 14:29
Espelhamento: Android e iOS
Espelhamento via cabo e via wireless
APP: AutoLink
FOTA Atualização: Suporta
OBS: Para futuras atualizações de software entrar em contato com o fabricante.

INFORMAÇÕES LOGÍSTICAS

Unidades por caixa: 06
Peso Bruto por unidade: 0,949kg
Peso Líquido por unidade: 0,790kg
Peso Bruto por Caixa: 6,150kg



YN-RAD91177



VISÃO GERAL

- Android 12
- Tamanho 2 DIN
- 7" Touch Screen Full HD, resistive touch
- Resolução 1080P
- Comando de Volante
- Entrada Câmera de Ré

CONECTIVIDADE

- Espelhamento Wireless
- Bluetooth 4.2
- GPS Offline Integrado
- Navegador Web
- Porta USB
- Porta MMC CARD / SD Card
- Controle Remoto

ÁUDIO & VÍDEO

- Máxima Potência
- Equalizador Multi
- Rádio Estéreo AM / FM
- 2 Saídas RCA Áudio
2 Saídas RCA Vídeo
- 1 Entrada Aux.
- 1 Entrada Subwoofer



Peso Embalagem: 1.175 gramas
Peso do Aparelho: 749 gramas
Tamanho da Caixa: 30 x 19,3 x 8 cm



CARACTERÍSTICAS TÉCNICAS

Gerais
 Voltagem DC 12V
 Potência: 4x45w
 Impedância: 8 Ohms
 Extensões:
 Saída de áudio: 4x45w
 Controle de Tons Graves (100Hz) / Agudos (10HZ):
 Temperatura de operação: -20°C - +60°C
 Idiomas: Inglês, Russo, Hebraico, Árabe, Português,
 Turco, Francês, Espanhol, Tailandês, Vietnamita
 Função Sleep: Possui
 Senha para configurações avançadas: 6556

Rádio
 Módulo Rádio:
 Frequência FM: 76-108Hz (América do Sul)
 Frequência AM: 520-1710Hz (América do Sul)
 Separação estéreo (1KHz): 25dB

Vídeo
 Sistema de vídeo: PAL/NTSC/SECAM
 Formatos de vídeo: MP4/MP5/RM/RMVB/AVI
 Formatos de imagem: BMP/GIF/JPG/PNG

Áudio
 Formatos de áudio: MP3,WMA
 Equalizador: JAZZ, POP, CLASSICO, ROCK, NOVO, URBANO, TECHNO

Bluetooth
 Bluetooth Áudio Streaming (Músicas)
 Bluetooth Hands-Free (Chamadas Telefônicas)
 Distância: 5 metros
 Tipo de comunicação: 4.2
 Nome: CAR-BT Senha: 0000

CARACTERÍSTICAS DO SISTEMA

Versão do Sistema: V2.11.500.31 191112_185731
 MCU: 01/03/2001 14:29
 Espelhamento: Android e iOS
 Espelhamento via cabo e via wireless
 APP: AutoLink
 FOTA Atualização: Suporta
 OBS: Para futuras atualizações de software entrar em contato com o fabricante.

INFORMAÇÕES LOGÍSTICAS

Unidades por caixa: 6
 Peso Bruto por unidade: 0,936kg
 Peso Líquido por unidade: 0,773kg
 Peso Bruto por Caixa: 6,05kg



YN-RAD1496A



USB POWER
Para recarga de seus aparelhos

CONECTIVIDADE

- Bluetooth 2.0
- Porta USB
- Porta MMC CARD / SD Card
- Entrada AUX
- Controle Remoto

ÁUDIO

- Máxima Potência
- Equalizador Multi
- Rádio FM
- MP3
- WMA



Peso Embalagem: 1.175 gramas
Peso do Aparelho: 749 gramas
Tamanho da Caixa: 30 x 19,3 x 8 cm



NOVA FUNÇÃO



COMANDO DE VOZ

A função não necessita estar conectado ao cabo USB. O aparelho ativa o recurso Siri do iPhone ou o Google Assistente. Para isso, precisa apenas de conexão bluetooth.



APP CONTROL
Controle seu aparelho via smartphone (Android / Apple)



CARACTERÍSTICAS TÉCNICAS

Gerais
Voltagem DC 12V
Potência: 3.12W
Impedância: 4-8 Ohms
Extensões:
Saída de áudio: 4 x 45w
Controle de Tons Graves (100Hz) / Agudos (10HZ):
Temperatura de operação: -10°C - +55°C
Função relógio: Possui
Função Sleep: Possui
Wireless: Bluetooth
Controle Remoto: via app e Way-Link
Senha para configurações avançadas: 6556

Rádio
Memória: 18 estações
Frequência FM: 76-108Hz (América do Sul)
Separação estéreo (1KHz): 25dB

Áudio
Formatos de áudio: MP3,WMA
Equalizador: POP/CLASSIC/ROCK

Bluetooth
Bluetooth Áudio Streaming (Músicas)
Bluetooth Hands-Free (Chamadas Telefônicas)
Distância: 5 metros
Tipo de comunicação: 2.0
Nome: CAR-BT Senha: NÃO TEM

INFORMAÇÕES LOGÍSTICAS

INFORMAÇÕES LOGÍSTICAS

Unidades por caixa:15
Peso Bruto por unidade: 0,468kg
Peso Líquido por unidade: 0,398kg
Peso Bruto por Caixa: 7,550kg



VL-RAD40680



CONECTIVIDADE

- Bluetooth 2.0
- Porta USB
- Porta MMC CARD / SD Card
- Entrada AUX
- Controle Remoto

ÁUDIO

- Máfixa Potência
- Equalizador Multi
- Rádio FM
- MP3
- WMA



Peso Embalagem: 1.175 gramas
 Peso do Aparelho: 749 gramas
 Tamanho da Caixa: 30 x 19,3 x 8 cm



APP CONTROL
 Controle seu aparelho via smartphone (Android / Apple)



CARACTERÍSTICAS TÉCNICAS

Gerais
 Voltagem DC 12v (10,8v - 15,1v)
 Potência: 1.68W
 Impedância: 4-8 Ohms
 Extensões:
 Saída de áudio: 4x 25w
 Controle de Tons Graves (100Hz) / Agudos (10HZ):
 Temperatura de operação: -10°C - +55°C
 Função relógio: Possui
 Função Sleep: Possui
 Wireless: Bluetooth
 Controle Remoto: via app E Way-Link
 Senha para configurações avançadas: NÃO TEM

Rádio
 Memória: 18 estações
 Frequência FM: 76-108Hz
 Separação estéreo (1KHz): ≤ 35dB
 Sensibilidade: ≤35 dB
 Distorção de tensão (Harmonia 1KHz): ≤ 5%

Áudio
 Formatos de áudio: MP3,WMA
 Equalizador: POP/CLASSIC/ROCK

Bluetooth
 Bluetooth Áudio Streaming (Músicas)
 Bluetooth Hands-Free (Chamadas Telefônicas)
 Distância: 5 metros
 Tipo de comunicação: 2.0
 Nome: CAR-BT Senha: NÃO TEM

INFORMAÇÕES LOGÍSTICAS

INFORMAÇÕES LOGÍSTICAS

Unidades por caixa:15
 Peso Bruto por unidade: 0,425kg
 Peso Líquido por unidade: 0,345kg
 Peso Bruto por Caixa: 6,950kg



YN-RAD50681



CONECTIVIDADE

- Bluetooth 2.0
- Porta USB
- Porta MMC CARD / SD Card
- Entrada AUX
- Controle Remoto via app

ÁUDIO

- Máxima Potência
- Equalizador Multi
- Rádio FM
- MP3
- WMA



Peso Embalagem: 1.175 gramas
 Peso do Aparelho: 749 gramas
 Tamanho da Caixa: 30 x 19,3 x 8 cm



APP CONTROL
 Controle seu aparelho via smartphone (Android / Apple)

CARACTERÍSTICAS TÉCNICAS

Gerais
 Voltagem DC 12v (10,8v - 15,1v)
 Potência: 1.68W
 Impedância: 4-8 Ohms
 Extensões:
 Saída de áudio: 4x 45w
 Controle de Tons Graves (100Hz) / Agudos (10HZ):
 Temperatura de operação: -10°C - +55°C
 Função relógio: Possui
 Função Sleep: Possui
 Wireless: Bluetooth
 Controle Remoto: Via app E Way-Link
 Senha para configurações avançadas: NÃO TEM

Rádio
 Memória: 18 estações
 Frequência FM: 76-108Hz
 Separação estéreo (1KHz): ≤ 35dB
 Sensibilidade: ≤35 dB
 Distorção de tensão (Harmonia 1KHz): ≤ 5%

Áudio
 Formatos de áudio: MP3,WMA
 Equalizador: POP/CLASSIC/ROCK

Bluetooth
 Bluetooth Áudio Streaming (Músicas)
 Bluetooth Hands-Free (Chamadas Telefônicas)
 Distância: 5 metros
 Tipo de comunicação: 2.0
 Nome: CAR-BT Senha: NÃO TEM

INFORMAÇÕES LOGÍSTICAS

INFORMAÇÕES LOGÍSTICAS

Unidades por caixa:15
 Peso Bruto por unidade: 0,477kg
 Peso Líquido por unidade: 0,403kg
 Peso Bruto por Caixa: 7,750kg



VL-RAD1863



CONECTIVIDADE

- Espelhamento Wireless
- Bluetooth 2.0
- Porta USB
- Porta MMC CARD / SD Card
- Entrada AUX
- Controle Remoto

ÁUDIO

- Máxima Potência
- Equalizador Multi
- Rádio FM
- MP3
- WMA



Peso Embalagem: 7,100 gramas
 Peso do Aparelho: 326 gramas
 Tamanho da Caixa: 30 x 19,3 x 8 cm



CARACTERÍSTICAS TÉCNICAS

Gerais
 Voltagem DC 12v (10,8v - 15,1v)
 Potência: 1.68W
 Impedância: 4-8 Ohms
 Extensões:
 Saída de áudio: 2x 25w
 Controle de Tons Graves (100Hz) / Agudos (10HZ):
 Temperatura de operação: -10°C - +55°C
 Função relógio: Possui
 Função Sleep: Possui
 Wireless: Bluetooth
 Controle Remoto: Integrado
 Senha para configurações avançadas: NÃO TEM

Rádio
 Memória: 18 estações
 Frequência FM: 76-108Hz
 Separação estéreo (1KHz): ≤ 35dB
 Sensibilidade: ≤35 dB
 Distorção de tensão (Harmonia 1KHz): ≤ 5%

Áudio
 Formatos de áudio: MP3,WMA
 Equalizador: POP/CLASSIC/ROCK
 Volume: 0-40

Bluetooth
 Bluetooth Audio Streaming (Músicas)
 Bluetooth Hands-Free (Chamadas Telefônicas)
 Distância: 5 metros
 Tipo de comunicação: 2.0
 Nome: CAR-BT Senha: NÃO TEM

INFORMAÇÕES LOGÍSTICAS

INFORMAÇÕES LOGÍSTICAS

Unidades por caixa: 20
 Peso Bruto por unidade: 0,326kg
 Peso Líquido por unidade: 0,258kg
 Peso Bruto por Caixa: 7,100kg



HASTE PARA ANTENA DE TETO UNIVERSAL

YN-ANT1788 - 20cm / 7,87"
YN-ANT2026 - 24cm / 9,44"

Aplicação em teto dianteiro e traseiro

Acompanha parafusos adaptadores

Para todos os tipos de veículos



Funcionalidade **AMPLIFICADA**



DETALHES TÉCNICOS:

- Voltagem: 12V
- Fonte de Luz: H3 12V/55W
- Material: ABS
- Suporte: Aço
- Peso: 1.200g
- Posição da Luz: Farol Auxiliar
- Consumo: 55W
- Material da Lente: Vidro
- Aprovado Norma ECE

ANTENA INTERNA UNIVERSAL

YN-ANT01



DETALHES TÉCNICOS:

- Voltagem: 12V
- Fonte de Luz: H3 12V/55W
- Material: ABS
- Suporte: Aço
- Peso: 1.200g
- Posição da Luz: Farol Auxiliar
- Consumo: 55W
- Material da Lente: Vidro
- Aprovado Norma ECE



RÁDIOS & CENTRAIS MULTIMÍDIAS, MELHOR EXPERIÊNCIA DE COMUNICAÇÃO, ENTRETENIMENTO E NAVEGAÇÃO!



SEGURANÇA

SEGURO

CINDY

CÂMERAS DE RÉ 2x1

VL-CA1354
YN-CA1384
YN-CR1881

 YN-CRA1886
PARA ANDROID

 YN-CRG1884
OLHO DE PEIXE

▶ **Opções:**
Frontal e Ré

▶ **2x1 - Pode ser usada encaixada no para-choque ou parafusada na placa traseira.**

 À PROVA D'ÁGUA E RESISTENTE À POEIRA

 EVITA BATIDAS

 **MAIS ATENÇÃO** COM AS CRIANÇAS E PETS.

FÁCIL INSTALAÇÃO

0%
DANIFICAÇÃO



Acompanha Broca serra copo 18,5mm



YN-CA1350

CÂMERA DE RÉ COM INFRAVERMELHO
8 LEDS

 À PROVA D'ÁGUA E RESISTENTE À POEIRA

 EVITA BATIDAS

 **MAIS ATENÇÃO** COM AS CRIANÇAS E PETS.



YN-CRF1883

CÂMERA DE RÉ COM INFRAVERMELHO
8 LEDS

 À PROVA D'ÁGUA E RESISTENTE À POEIRA

 EVITA BATIDAS

 **MAIS ATENÇÃO** COM AS CRIANÇAS E PETS.



YN-CA1352

MINI CÂMERA DVR

 Visão Noturna

 720px HD
Resolução da Câmera

 Ampla Ângulo da lente



YN-CRTG1885

CÂMERA DE RÉ TIPO TARTARUGA

 À PROVA D'ÁGUA E RESISTENTE À POEIRA

 EVITA BATIDAS

 **MAIS ATENÇÃO** COM AS CRIANÇAS E PETS.

 Ampla Ângulo da lente

 LENTE OLHO DE PEIXE



YN-DV1393

MINI CÂMERA DVR

 Visão Noturna

 Alta Sensibilidade

 FULL HD
Resolução da Câmera 1080p

 Ampla Ângulo da lente



YN-CDRE03

CÂMERA DE RÉ TIPO TARTARUGA

 À PROVA D'ÁGUA E RESISTENTE À POEIRA

 EVITA BATIDAS

 **MAIS ATENÇÃO** COM AS CRIANÇAS E PETS.

 Ampla Ângulo da lente

 LENTE OLHO DE PEIXE



POSSUI LINHAS
GUIAS DE APROXIMAÇÃO

145°

SENSORES DE RÉ

YN-SR002GF - GRAFITE

- ▶ Função Self-Test
- ▶ Aviso Sonoro Configurável
- ▶ Distância de Operação: 0,3 a 0,2M
- ▶ 4 Pontos Sensoriais sem Plug na Extensão do Cabo

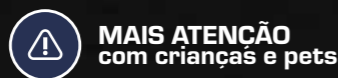

YN-SR002POF
PRETO FOSCO

YN-SR002BR
BRANCO

YN-SR002POB
PRETO BRILHO

YN-SR002PA
PRATA

YN-SR002VM
VERMELHO

YN-SR0725 - PRETO

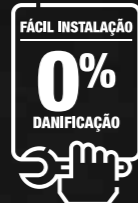

YN-SR1503 - PRETO
YN-SR1504 - BRANCO
YN-SR1505 - PRATA



- ▶ Função Self-Test
- ▶ Aviso Sonoro Configurável
- ▶ Distância de Operação: 0,3 a 0,2M
- ▶ 4 Pontos Sensoriais sem Plug na Extensão do Cabo

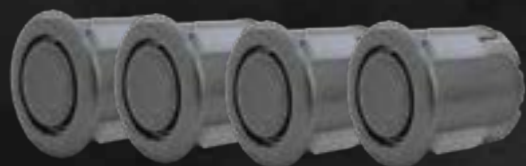

RETROVISOR COM TELA LCD E CÂMERA DE RÉ

YN-VC01



- Kit Completo de Instalação
- Alimentação: DC 12V/24V
- Potência: 12V
- Display: 4.3"/10,9cm
- Formato: 16:9
- Resolução: 640x480px

RETROVISOR COM TELA LCD

YN-VC02



- Kit Completo de Instalação
- Alimentação: DC 12V/24V
- Potência: 12V
- Display: 4.3"/10,9cm
- Formato: 16:9
- Resolução: 640x480px

DVR VEICULAR COM TELA LCD E CÂMERA DE RÉ

YN-CDVE01

- Kit Completo de Instalação
- Alimentação: DC 12V/24V
- Potência: 12V
- Display: 4.3"/10,9cm
- Formato: 16:9
- Resolução: 640x480px



KIT MONITOR COM TELA LCD E CÂMERA DE RÉ

YN-VC06

- Kit Completo de Instalação
- Alimentação: DC 12V/24V
- Potência: 12V
- Display: 4.3"/10,9cm
- Formato: 16:9
- Resolução: 480x272px
- Duas entradas de vídeo



Acompanha: 2 Câmeras

Câmera 2x1 Pode ser usada de duas formas:



KIT RETROVISOR COM TELA LCD E CÂMERA DE RÉ COM SENSOR

YN-SR0726 - PRETO
YN-SR0727 - BRANCO
YN-SR0728 - PRATA

- Kit Completo de Instalação
- Alimentação: DC 12V/24V
- Potência: 12V
- Display: 4.3"/10,9cm
- Formato: 16:9
- Resolução: 480x272px
- Duas entradas de vídeo



Câmera 2x1 Pode ser usada de duas formas:



SENSORES: TRÊS OPÇÕES DE CORES

YN-ESP001

ESPELHO CONVEXO (MAMÃE E BEBÊ)



- Composição: ABS
- Tamanho ideal, não atrapalha o motorista
- Diminui os pontos cegos do interior do veículo
- Instalação universal, para todo tipo de retrovisor.
- Traseira com clip-on para fixação.

Rotação livre 360°
Movimentos para cima e para baixo

YN-ESP001

ESPELHO RETROVISOR PANORÂMICO



- Composição: ABS e Metal
- Tamanho ideal, não atrapalha o motorista
- Diminui os pontos cegos do interior do veículo
- Instalação universal, para todo tipo de retrovisor.
- Traseira com clip-on para fixação.

CARRO COM RETROVISOR ORIGINAL DO CARRO

CARRO COM RETROVISOR E ESPELHO CONVEXO

ÂNGULO DO RETROVISOR INTERNO

ÂNGULO DO RETROVISOR COM ESPELHO CONVEXO

ESPELHOS CONVEXO PARA RETROVISOR

YN-ESP002 - Par

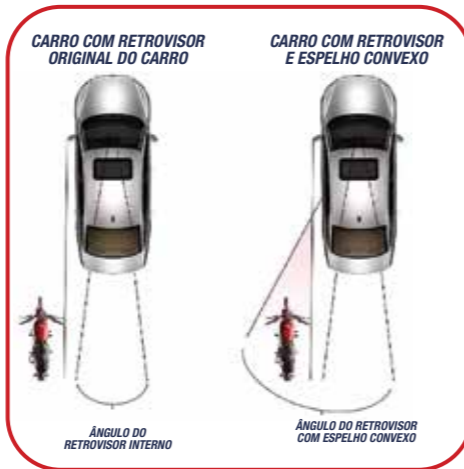

CARRO COM RETROVISOR ORIGINAL DO CARRO

CARRO COM RETROVISOR E ESPELHO CONVEXO

ÂNGULO DO RETROVISOR INTERNO

ÂNGULO DO RETROVISOR COM ESPELHO CONVEXO

FÁCIL INSTALAÇÃO

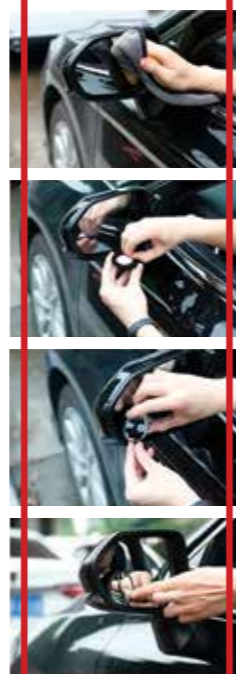

YN-ESP003 - Unitário



YN-ESP1179

- Composição: ABS
- Cor: Preto
- Peso: 100g
- Tamanho ideal, não atrapalha o motorista
- Rotação 360° graus
- Instala no para-brisa ou no vidro traseiro

ESPELHO CONVEXO
ADAPTÁVEL PARA FRENTE E ATRÁS



PARA UMA VIAGEM SEGURA E TRANQUILA, MANTENDO MAIOR VISIBILIDADE DO SEU BEBÊ NO BANCO DE TRÁS.



ROTAÇÃO 360°

FÁCIL INSTALAÇÃO

COM PRESILHA OU VENTOSA





CUSTOM

CUSTOM & REPARO

& REPARO



CABO CHUPETA

Garante maior praticidade e segurança ao recarregar a bateria do seu carro.



YN-CAC001

32/CX



- 2 Cabos com garras tipo jacaré
- Cabos emborrachados
- Composição: Cobre, PVC, Ferro, Alumínio e Borracha



YN-CAC002

20/CX



- 2 Cabos tipo pinça
- Cabos emborrachados
- Composição: Cobre, PVC, Ferro, Alumínio e Borracha



YN-CAC005

40/CX



- 2 Cabos tipo pinça
- Cabos emborrachados
- Composição: Cobre, PVC, Ferro, Alumínio e Borracha



YN-TB0634



YN-TB1153

TAMPA DE BICO DE PINO YN-TB1154

250/CX



YN-TB1155



YN-TB0636



YN-TB1159

TAMPA DE BICO DE PINO YN-TB1160

250/CX



YN-TB1161



YN-TB0635



YN-TB1156

TAMPA DE BICO DE PINO YN-TB1157

250/CX



YN-TB1158



CAPA PARA PARAFUSO DE RODA

150/CX. CADA

YN-TF1591
17MM

YN-TF1592
19MM



MINI COMPRESSOR DE AR

YN-AR001
20/CX



Compatível para encher pneus de carros leves, bicicletas e moto.



Manguera de 39cm para encher seu pneu rapidamente



03 bicos adaptadores



Com cabo de conexão de 2,8m e entrada para plug de isqueiro



Acompanha medidor embutido com pressão máxima de 300psi



KIT DE TAPETES AUTOMOTIVOS 100% BORRACHA

ESPECIFICAÇÕES TÉCNICAS:

- Tamanho dianteiro: 70cm x 50cm
- Tamanho traseiro: 50cm x 50cm
- Cores: Prata / Vermelho / Grafite
- Anti odor e Anti alérgico

COMPOSIÇÃO:

- Borracha (PVC)

COMPATIBILIDADE:

- Modelo UNIVERSAL, pode ser utilizado em todos os carros.

CONTEÚDO:

- 02 tapetes dianteiros
- 02 tapetes traseiros



CAPAS DE VOLANTE

Couro Ecológico



- Excelente acabamento
- Grip antideslizante
- Fácil de limpar
- Super Comfort
- Costura resistente em linha vermelha
- Modelagem ideal para o seu volante
- Alta Durabilidade e Qualidade

MINI VENTILADORES

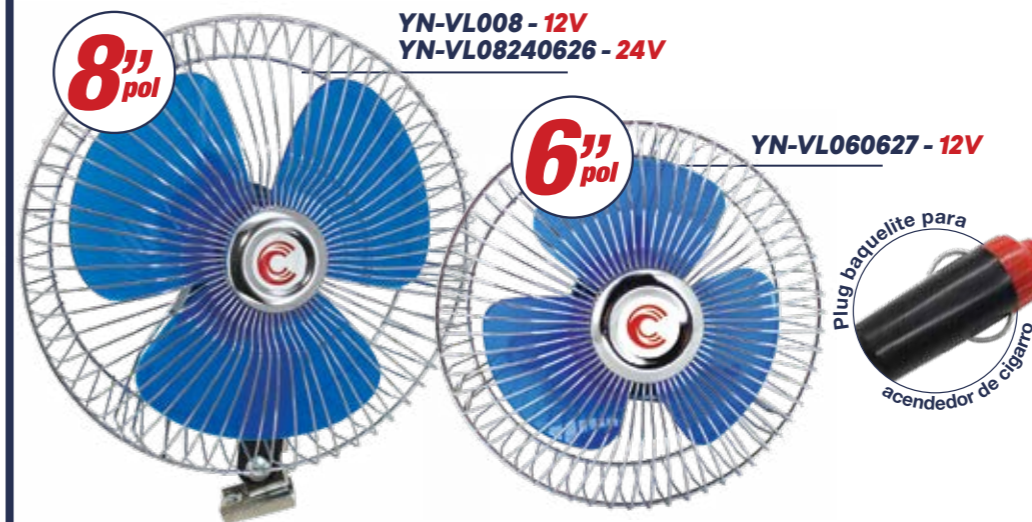

FÁCIL INSTALAÇÃO POR GARRA

ESPECIFICAÇÕES TÉCNICAS:

- Tamanho Cabo: 1,22m
- Cor: Azul
- Fixação por garra
- Garra removível

COMPOSIÇÃO:

- Ferro e Plástico



Todos os modelos atendem a vários tipos de veículos.



FÁCIL INSTALAÇÃO POR FITA DUPLA FACE

ESPECIFICAÇÕES TÉCNICAS:

- Alimentação: 12V
- Potência: 3W
- Tamanho: 10,8cm/4,25"
- Cor: Preto
- Fixação por fita dupla face
- Ajuste manual

COMPOSIÇÃO:

- Ferro e Plástico



ACENDEDOR DE CIGARRO



Modelo Universal

- Alimentação do botão acendedor: 12v
- Alimentação base do acendedor: 12v/24v

FITAS ISOLANTES



- Uso profissional
- Alta flexibilidade
- Alta durabilidade
- Alta aderência
- Anti-chama
- ISO9002



CHAVES DE RODA

YN-CHC02
CHAVE DE RODA ALONGÁVEL EXTENSÍVEL
AÇO CROMADO VANÁDIO
20/CX



YN-CHV1888
KIT CHAVE DE VELA 8 PEÇAS COM EXTENSORES
AÇO CROMADO VANÁDIO
40/CX



YN-CHV01 30CM
YN-CHV03 20CM
YN-CHV1152 30CM
YN-CHV1315 30CM
CHAVE DE VELA BLISTER
AÇO CROMADO VANÁDIO
60/CX. CADA



YN-CHV02
JOGO CHAVE DE VELA ARTICULÁVEL COM SOQUETE ENCAIXE
AÇO CROMADO VANÁDIO
50/CX



YN-CHC01
CHAVE DE RODA TIPO CRUZ 17 X 19CM COM 4 SOQUETES
AÇO CROMADO VANÁDIO
20/CX

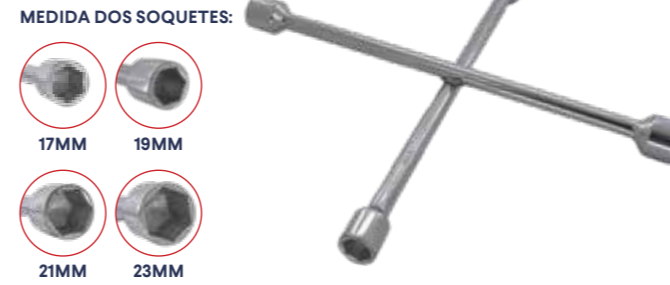

YN-CHC01E
CHAVE DE RODA TIPO CRUZ 17 X 19CM COM ESPÁTULA
AÇO GALVANIZADO SEM BRILHO
20/CX

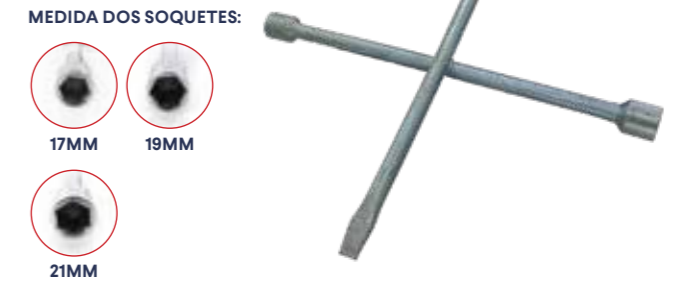

YN-CHC01G
CHAVE DE RODA TIPO CRUZ 17 X 19CM COM 4 SOQUETES
AÇO GALVANIZADO SEM BRILHO
20/CX

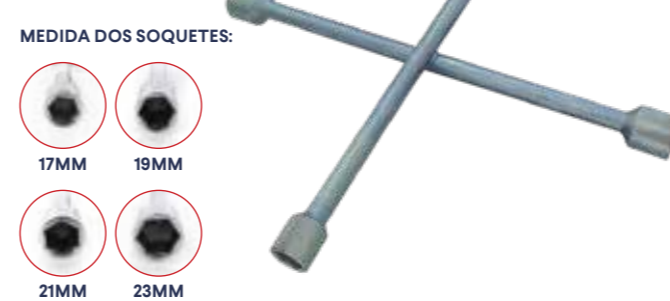

YN-CHC1246
CHAVE DE RODA TIPO CRUZ 20" PROFESSIONAL LONGA
AÇO CROMADO VANÁDIO
12/CX



YN-CHC017
YN-CHC019
YN-CHC210785
CHAVE DE RODA TIPO L COM ESPÁTULA
AÇO GALVANIZADO SEM BRILHO
60/CX. CADA



YN-CHL2069
YN-CHL2070
YN-CHL2071
YN-CHL2072
YN-CHL2073
YN-CHL2074
YN-CHL2075
YN-CHL2076
YN-CHL2077
YN-CHL2078
YN-CHL2079
CHAVE BIELA TIPO L
AÇO CARBONO COM BRILHO





- SISTEMA HIDRÁULICO
- PARA AUTOMÓVEIS DE PASSEIO E UTILITÁRIOS
- PERMITE ELEVAR COM SEGURANÇA E FACILIDADE
- PEQUENO E LEVE
- OPERAÇÃO SIMPLES E SEGURA
- IDEAL PARA TROCA FÁCIL DE PNEUS E MANUTENÇÃO DO SEU AUTOMÓVEL

Haste ajustável para altura adequada de operação
A haste do pistão e o cilindro do óleo sobem e descem em movimento linear

Topo com sulcos em cruz (segmento de contato de carga)

Fixe o corpo da bomba de revestimento do cilindro de óleo na parte inferior, para evitar vazamentos durante a operação.

Pressionando a alça para cima e para baixo faz a haste do pistão subir.

A válvula de liberação é para controlar a função de elevação ou descida.



YN-TV001

TRAVA DE VOLANTE UNIVERSAL

- 2 CHAVES TETRA (ANTIMICHA)
- FABRICADO EM AÇO
- REVESTIDO EM VINIL
- TAM. FECHADO: 51CM
- TAM. ABERTO: 69CM
- FÁCIL INSTALAÇÃO



YN-TV001

TRAVA CABO DE AÇO

- 2 CHAVES (ANTIMICHA)
- REVESTIDO COM MANGUEIRA CRISTAL
- TAMANHO: 25MM Ø
- TAMANHO: 120CM
- FÁCIL INSTALAÇÃO

APLICAÇÃO:
MOTO, BICICLETA, PORTÃO, ESTEPE, BARCOS, TRAILERS, E OUTROS.



YN-TV006

TRAVA ELÉTRICA 4 PORTAS 2 MASTERS

- 1 TRAVA MESTRA 5 FIOS E 3 TRAVAS ESCRAVAS 2 FIOS
- MOTOR INDIVIDUAL 5 FIOS
- CABEÇA GIRATÓRIA 360°
- SISTEMA DE OPERAÇÃO: PORTA OU BOTÃO
- SISTEMA DE CONTROLE: PORTA DIANTEIRA DO CONDUTOR
- CHICOTE: ESPAGUETADO COM PROTEÇÃO ANTI INFILTRAÇÃO



YN-TV007

TRAVA DE PEDAL COM ALGEMA

- 2 CHAVES TETRA (ANTIMICHA)
- FABRICADO EM AÇO
- REVESTIDO EM VINIL
- TAM. FECHADO: 51CM
- TAM. ABERTO: 69CM
- FÁCIL INSTALAÇÃO



YN-TV002

TRAVA DE VOLANTE UNIVERSAL

- 2 CHAVES TETRA (ANTIMICHA)
- FABRICADO EM AÇO
- REVESTIDO EM VINIL
- TAM. FECHADO: 51CM
- TAM. ABERTO: 69CM
- FÁCIL INSTALAÇÃO



YN-TV002

TRAVA PARA FREIO DE MÃO E CÂMBIO UNIVERSAL

- 2 CHAVES TETRA (ANTIMICHA)
- FABRICADO EM AÇO
- TAM. FECHADO: 35CM
- TAM. ABERTO: 53CM
- FÁCIL INSTALAÇÃO

ATENÇÃO:
NÃO ADAPTÁVEL EM VEÍCULOS COM CÂMBIO AUTOMÁTICO



YN-TV008

MOTOR TRAVA ELÉTRICA

- MOTOR AUXILIAR COM 2 FIOS
- MONO SERVENTIA: A PORTA DO MOTORISTA COMANDARÁ O DESTRAVAMENTO E TRAVAMENTO DAS DEMAIS
- COMPATÍVEL COM CENTRAIS DE ALARMES



YN-RL1414

CENTRALINA DE TRAVA ELÉTRICA

- 8 PINOS 12V
- COMPATÍVEL PARA 2 OU 4 PORTAS
- COMPATÍVEL COM MOTOR DE 2 OU 5 FIOS
- ENCAIXE UNIVERSAL
- ACOMPANHA CHICOTE





PEÇAS CINOY

PEÇAS

YN-BZP201

BUZINA CORTEJAR (BIBI) - PAR
UNIVERSAL - 12v



SOM GRAVE E AGUDO

TERMINAL DE CONEXÃO

YN-BZP1781

BUZINA CORTEJAR - PAR
UNIVERSAL - 12v



SOM GRAVE E AGUDO

TERMINAL DE CONEXÃO

YN-BZP101

BUZINA CORTEJAR (BIBI) - UNITÁRIO
UNIVERSAL - 12v



SOM GRAVE E AGUDO

TERMINAL DE CONEXÃO

YN-BZM101

BUZINA CORTEJAR (BIBI) - UNITÁRIO
UNIVERSAL - 12v



SOM GRAVE E AGUDO

TERMINAL DE CONEXÃO

YN-BZC201

BUZINA CARACOL - PAR
UNIVERSAL - 12v



TERMINAL DE CONEXÃO

YN-BZC1780

BUZINA CARACOL - PAR
UNIVERSAL - 12v



TERMINAL DE CONEXÃO

YN-BZC101

BUZINA CARACOL - UNITÁRIO
UNIVERSAL - 12v



TERMINAL DE CONEXÃO

YN-BZCFT / BZCGM / BZCVW

BUZINA CARACOL - PAR
12v



APLICAÇÃO:
FIAT **gm** **VW**

TERMINAL DE CONEXÃO

YN-BZ0694

BUZINA 3 CORNETAS
UNIVERSAL - 12v

- Cornetas Vermelhas
- Chave Acionadora
- Mini Compressor
- Tubo Transparente
- Kit de Anilhas e Parafusos
- Relê

Fabricação em Plástico Resistente

Buzina Barulhenta e Diferenciada



Mini Compressor 12V

Efeito Alternado

Efeito Contínuo

FÁCIL INSTALAÇÃO
0%
DANIFICAÇÃO

YN-BZ1282

BUZINA DE METAL CROMADA
UNIVERSAL - 12v

Para instalação em veículos:



Potência e Segurança na hora de buzinar na rua ou no mar.

Som Alto que alerta!



EMPILE 4 EMBALAGENS para formar uma imagem única. Referência de posição no canto direito de cada lado das embalagens.

YN-EDA802

Tensão: 12V

1 Saída Tipo Universal para:

- Gasolina, como reservatório de gasolina partida a Frio.
- Água, como reservatório de água do limpador do para-brisa dianteiro e traseiro.

Aplicação:

- CHEVROLET CELTA
- CHEVROLET CORSA

YN-EDA820

Tensão: 12V

1 Saída Tipo Universal para:

- Gasolina, como reservatório de gasolina partida a Frio.
- Água, como reservatório de água do limpador do para-brisa.

Aplicação:

- TODOS OS MODELOS

YN-EDA806

Tensão: 12V

1 Saída Tipo Universal para:

- Gasolina, como reservatório de gasolina partida a Frio.
- Água, como reservatório de água do limpador do para-brisa.

Aplicação:

- FIAT PALIO
- FIAT WEEKEND

YN-EDA806-24

Tensão: 24V

1 Saída Tipo Universal para:

- Gasolina, como reservatório de gasolina partida a Frio.
- Água, como reservatório de água do limpador do para-brisa dianteiro e traseiro.

Aplicação:

- LINHA PESADA

YN-EDA807

Tensão: 12V

1 Saída Tipo Universal para:

- Gasolina, como reservatório de gasolina partida a Frio.
- Água, como reservatório de água do limpador do para-brisa dianteiro e traseiro.

Aplicação:

- VW GOL
- VW PARATI

YN-EDA820-24

Tensão: 24V

1 Saída Tipo Universal para:

- Gasolina, como reservatório de gasolina partida a Frio.
- Água, como reservatório de água do limpador do para-brisa dianteiro e traseiro.

Aplicação:

- LINHA PESADA

YN-TM1284

CARÇA COM VÁLVULA TERMOSTÁTICA

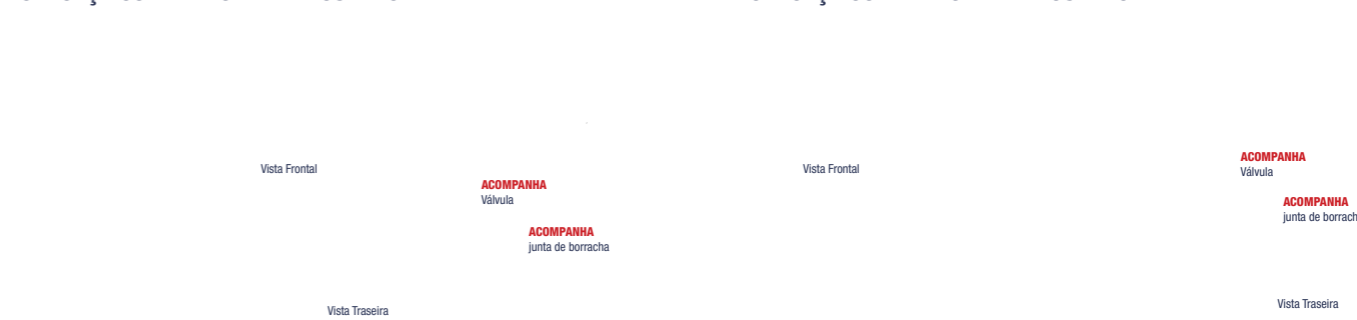

APLICAÇÃO:

- | | |
|------------------|-------------|
| CELTA 2001» | DOBLÓ 2004» |
| COBALT 1.4 TODOS | IDEIA 2006» |
| CORSA 1999» | PALIO 2003» |
| MERIVA 2002» | PUNTO 2008» |
| MONTANA 2004» | SIENA 2003» |
| PRISMA 2006» | STILO 2003» |

YN-TM1285

CARÇA COM VÁLVULA TERMOSTÁTICA

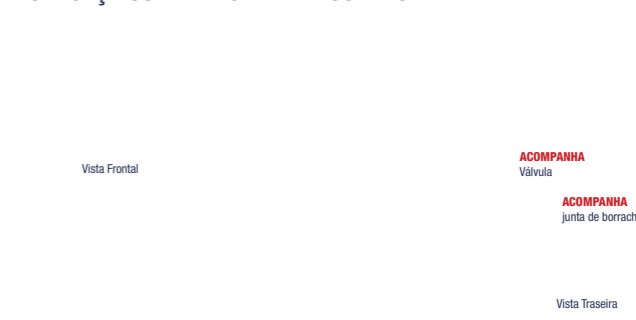

APLICAÇÃO:

- | | |
|--------------------|---------------------|
| 206/207 TODOS | C3 2005» |
| 307 2.0 1998» | XSARA PICASSO 2006» |
| PARTINER 1996»2002 | |
| HOGGAR 2010» | |

YN-TM1286

CARÇA COM VÁLVULA TERMOSTÁTICA



APLICAÇÃO:

- ECOSPORT 2005»2014
Ka 2005»2014

YN-TM1287

CARÇA COM VÁLVULA TERMOSTÁTICA

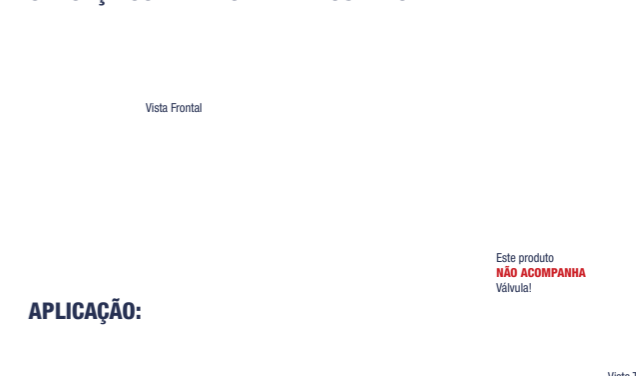

APLICAÇÃO:

- C3 2003»2012

- 206 2005»2010
207 2009»2013

YN-TM1288

CARÇA COM VÁLVULA TERMOSTÁTICA



APLICAÇÃO:

- ECOSPORT 2005»2014
FIESTA FLEX 2005»2014
Ka 2005»2014

YN-TM1355

CARÇA COM VÁLVULA TERMOSTÁTICA



APLICAÇÃO:

- ECOSPORT FLEX 2005»2014
FIESTA FLEX 2005»2014
Ka FLEX 2005»2014

YN-TM1356

CARCAÇA COM VÁLVULA TERMOSTÁTICA



APLICAÇÃO:



- CRUZE HATCH/SEDAN 1.8 2011»2016
- SONIC 1.6 2012»2014
- TRACKER 1.8 2014»2016

YN-TM1357

CARCAÇA COM VÁLVULA TERMOSTÁTICA



APLICAÇÃO:



- BRAVA 1996»2000
- PALIO 1.6 1996»1998
- SIENA 1.6 1998»
- STRADA 1999»2000

YN-TM1358

CARCAÇA COM VÁLVULA TERMOSTÁTICA



APLICAÇÃO:



- GRAND SIENA
- MOBI
- NOVO FIORINO
- PALIO ESSENCE
- UNO NOVO VIVACE

YN-TM1763

CARCAÇA COM VÁLVULA TERMOSTÁTICA



APLICAÇÃO:



- AUDI A3 2002»
- CROSSFOX 2005»
- FOX 2003»
- GOLF 2002»
- GOL G5 2008»2013
- GOL G6 2013
- PÓLO 2004»2006
- SAVEIRO 2009»
- SPACEFOX 2006»
- VOYAGE G5 2008»2013
- VOYAGE G6 2013»

YN-M1593

MOTOR PARA VENTONINHA DE RADIADOR UNIVERSAL

- Tensão: 12V
- Tamanho Motor 101mm Ø
- Pino Adaptador 8mm
- Eixo 5mm Ø
- Rotação Anti-horário
- Carros com ou sem ar condicionado



YN-RL05

RELÊ AUXILIAR - 5 PINOS COM SUPORTE

- Tensão: 12V
- Potência: 450W
- Funciona em motos
- Funciona em linha pesada

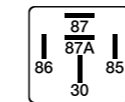

APLICAÇÃO:



YN-TB01

TERMINAL DE BATERIA

- Tensão: 12V
- Utilização:
 - Cabos entre 16mm e 90mm
- Composição:
 - Metal
- Peso:
 - 80g
- Conteúdo:
 - Par



YN-RL03

RELÊ AUXILIAR - 3 PINOS DO PISCA COM SUPORTE

- Tensão: 12V
- Potência: 21W+18W+1.4W
- Comando do pisca-pisca
- Funciona em motos



APLICAÇÃO:



YN-RLA01

RELÊ AR CONDICIONADO - 4 PINOS SEM SUPORTE

- Tensão: 12V
- Funciona em motos
- Funciona em linha pesada

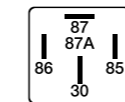

APLICAÇÃO:



YN-RL04

RELÊ AUXILIAR - 4 PINOS COM SUPORTE

- Tensão: 12V
- Funciona em motos
- Funciona em linha pesada

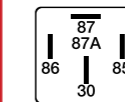

APLICAÇÃO:



YN-MF1481

MOTOR TRAVA ELÉTRICA

- Motor tipo: Mabuchi
- Engrenagem: 9 dentes
- Alimentação: DC 12V

ENGRENAGEM
• 7mm
• 9 dentes



APLICAÇÃO:

FIAT

- PALIO 2011
- SIENA 2011
- STRADA 2011

YN-MOV01CD

MOTOR PARA MÁQUINA DE VIDRO DIREITO

- Tensão: 12V
- Consumo: 1,3A
- Força: 9,12N.m / 93Kg.cm
- Compatibilidade: somente motores mabuchi



ENGRENAGEM
• 17mm
• 8 dentes

YN-MOV02PE

MOTOR PARA MÁQUINA DE VIDRO ESQUERDO

- Tensão: 12V
- Consumo: 1,3A
- Força: 9,12N.m / 93Kg.cm
- Compatibilidade: somente motores mabuchi

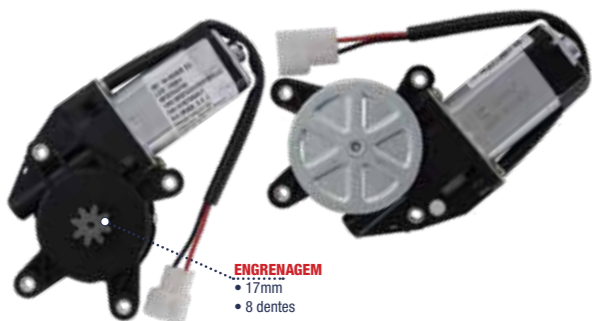

ENGRENAGEM
• 17mm
• 8 dentes

YN-MF1482

MOTOR TRAVA ELÉTRICA

- Motor tipo: Mabuchi
- Engrenagem: 9 dentes
- Alimentação: DC 12V



APLICAÇÃO:

- FOX G2 2009
- GOL G5 2008-2012
- GOL G6 2011-2015
- SAVEIRO G5 2008-2013
- SAVEIRO G6 2012-2013
- SPACEFOX G2 2009-2013
- VOYAGE G2 2007-2012
- VOYAGE G3 2011-2015

YN-M24D/1576

MOTOR PARA MÁQUINA DE VIDRO DIREITO

- Tensão: 12V
- Consumo: 1,3A
- Força: 9,12N.m / 93Kg.cm
- Compatibilidade: somente motores mabuchi



ENGRENAGEM
• 17mm
• 8 dentes

YN-M24E/1577

MOTOR PARA MÁQUINA DE VIDRO ESQUERDO

- Tensão: 12V
- Consumo: 1,3A
- Força: 9,12N.m / 93Kg.cm
- Compatibilidade: somente motores mabuchi

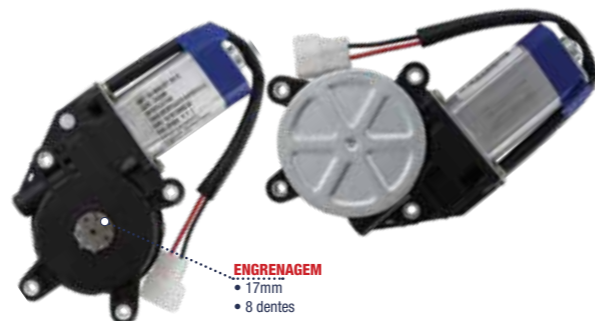

ENGRENAGEM
• 17mm
• 8 dentes

YN-CEB01

CEBOLÃO RADIADOR INTERRUPTOR DE VENTONINHA

- Acionamento: 86°C
- Desligamento: 76°C
- Pinos conectores: 2
- Rosca M22 x 1,5mm



APLICAÇÃO:



YN-CEB0757

CEBOLÃO RADIADOR INTERRUPTOR DE VENTONINHA

- Acionamento: 102°C
- Desligamento: 95°C
- Pinos conectores: 3
- Rosca M22 x 1,5mm



APLICAÇÃO:



YN-CEB0760

SENSOR DE TEMPERATURA DE ÁGUA

- Acionamento: 97°C
- Desligamento: 92°C
- Pinos conectores: 3
- Rosca M22 x 1,5mm



APLICAÇÃO:



YN-CEB1324

SENSOR DE TEMPERATURA DE ÁGUA

- Encaixe 20mm
- Conector 2 pinos



APLICAÇÃO:



YN-CEB1327

SENSOR DE TEMPERATURA DE ÁGUA

- Rosca M12 x 1,5mm
- Conector 2 pinos



APLICAÇÃO:



YN-CEB02

CEBOLÃO RADIADOR INTERRUPTOR DE VENTONINHA

- Acionamento: 92°C
- Desligamento: 87°C
- Pinos conectores: 2
- Rosca M22 x 1,5mm



APLICAÇÃO:



YN-CEB0758

CEBOLÃO RADIADOR INTERRUPTOR DE VENTONINHA

- Acionamento: 92°C
- Desligamento: 81°C
- Pinos conectores: 2
- Rosca M22 x 1,5mm



APLICAÇÃO:



YN-CEB1322

SENSOR DE TEMPERATURA DE ÁGUA

- Rosca M12 x 1,5mm
- Conector 2 pinos



APLICAÇÃO:



YN-CEB1325

SENSOR DE TEMPERATURA DE ÁGUA

- Encaixe 20mm
- Conector 4 pinos



APLICAÇÃO:



YN-CEB1328

SENSOR DE TEMPERATURA DE ÁGUA

- Conector 2 pinos
- Borracha de vedação 19mm



APLICAÇÃO:



YN-CEB03

CEBOLÃO RADIADOR INTERRUPTOR DE VENTONINHA

- Acionamento: 75°C
- Desligamento: 70°C
- Pinos conectores: 2
- Rosca M22 x 1,5mm



APLICAÇÃO:



YN-CEB0759

CEBOLÃO RADIADOR INTERRUPTOR DE VENTONINHA

- Acionamento: 92°C
- Desligamento: 87°C
- Pinos conectores: 2
- Rosca M22 x 1,5mm



APLICAÇÃO:



YN-CEB1323

SENSOR DE TEMPERATURA DE ÁGUA

- Rosca M12 x 1,5mm
- Conector 2 pinos



APLICAÇÃO:



YN-CEB1326

SENSOR DE TEMPERATURA DE ÁGUA

- Rosca M12 x 1,5mm
- Conector 2 pinos



APLICAÇÃO:



YN-SE1778

SENSOR DE TEMPERATURA DE ÁGUA

- Plug Eletrônico (Água)
- Circuito Simples
- Conector 2 pinos
- Carcaça Plástica



APLICAÇÃO:







RUA FRANCISCO PORTELA, 925
GRAMACHO, DUQUE DE CAXIAS - RJ, 25055-210
21 2784 1600
CINOY.COM.BR

